

Printer 250

Reference and Programmer's Manual

VeriFone Manual Part Number 10692, Revision C
Manual Revision 1.0

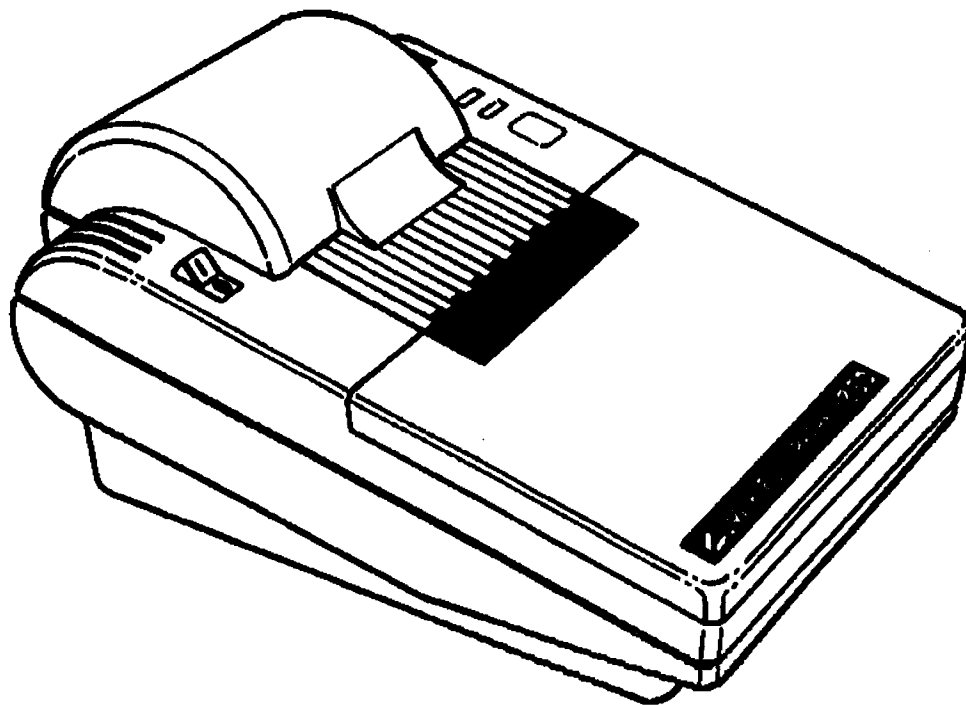

Printer 250 Reference and Programmer's Manual

VeriFone Manual Part Number 10692, Revision C
Manual Revision 1.0

Published: August 1994

VeriFone®, Inc.
Three Lagoon Drive
Redwood City, CA 94065
TEL: 415-591-6500
TELEX: 5106007959

Printed in the United States of America
© 1994 VeriFone, Inc. All rights reserved.

No part of this publication may be copied, distributed, stored in a retrieval system, translated into any human or computer language, transmitted, in any form or by any means, without the prior written consent of VeriFone, Inc.

Publications are not stocked at the address given above. Requests for VeriFone publications should be made to your VeriFone representative.

VeriFone, ZON and TRANZ are registered trademarks of VeriFone, Incorporated. IBM, IBM PC and IBM AT are registered trademarks of International Business Machines.

All other brand names appearing in this manual are the trademarks of their respective holders.

Table of Contents

1. Setting Up the Printer 250

Selecting a Location for Your Printer	1 - 1
Unpacking Your Printer	1 - 2
Setting the DIP Switches	1 - 2
Switch 1	1 - 3
Switch 2	1 - 3
Switches 3 and 4	1 - 3
Installing the Printer 250	1 - 4
Power Connection.....	1 - 4
Terminal Connection.....	1 - 4
Removing or Replacing the Ribbon Cartridge	1 - 5
Installing the Paper Roll	1 - 6
Removing the Paper Roll	1 - 7
Running the Print Test	1 - 7
Maintenance	1 - 7
Cleaning	1 - 7
Periodic Check.....	1 - 7

2. Printer 250 Basics

Control Panel.....	2 - 1
Printer Features.....	2 - 2
Command Set	2 - 2
Printable Characters.....	2 - 2
Character Set and Font Data Organization	2 - 3
Error Detection and Recovery.....	2 - 3

3. Printer 250 Commands

Execution Commands	3 - 2
Print Buffer Contents (LF).....	3 - 2
Eject Paper (FF)	3 - 2
Change Ribbon Color (DC2)	3 - 3
Empty Print Buffer and Cancel Character Attributes (CAN)	3 - 3
Set Line Height to "n" Dots (ESC a)	3 - 3
Eject Paper "n" Lines (ESC b).....	3 - 4
Reset Printer to Power-Up State (ESC c).....	3 - 4
Request Printer Status (ESC d)	3 - 4
Enter Native Mode (FS).....	3 - 4
Enter Printer 200 Emulation Mode (GS)	3 - 5
Pad Character (NUL).....	3 - 5

Table of Contents

Advanced Commands	3 - 5
Double-Width Mode or Select High-Page Graphics (RS or SO)	3 - 5
Normal-Width Mode or Select ASCII Character Set (US or SI)	3 - 6
Set Right Margin (ESC e).....	3 - 6
Select Line Attribute (ESC f)	3 - 7
Printer Identification (ESC i)	3 - 7
Retrieve Printer Information (ESC r)	3 - 7
Download Character (ESC l)	3 - 8
Print Mode Commands	3 - 9
Activate Dot Graphics Mode (ESC g).....	3 - 9
Printable Images	3 - 10
Graphic Line Terminators	3 - 10
Select Character Set (ESC h)	3 - 11
Select Cyrillic Font (ETX)	3 - 11

4. General Specifications

Printer	4 - 1
Character Set and Size	4 - 1
Column and Line Spacing.....	4 - 1
Paper Specifications.....	4 - 1
Inking	4 - 2
Case Dimensions and Weight.....	4 - 2
Electrical Specifications.....	4 - 2
Environmental Specifications	4 - 2
Power Supply Unit.....	4 - 2
Serial Interface	4 - 2

Appendix A: Standard Character Set

Character Codes	A - 1
Fonts.....	A - 1
Driver	A - 1
Files	A - 1
Country-Dependent Codes.....	A - 2
Font Images	A - 2

Appendix B: Slavic Character Set

Appendix C: Cyrillic Character Set

1. Setting Up the Printer 250

The VeriFone Printer 250 is a low cost, high performance roll printer. It combines the versatility of a dot matrix printer with a small footprint and a wide range of features to satisfy the printing needs of transaction processing operations. Printer 250 features include:

- Printing of double-width, double-height, double-width and double-height characters, and bit-addressable graphics
- Built-in international character sets
- Selectable character fonts
- Ability to print on single-, 2- or 3-part roll paper
- Dual color (red/black) print mechanism and ribbon (optional single color mechanism and ribbon available on special order)
- External power pack, reducing both weight and bulk from the actual printer enclosure

All VeriFone products capable of controlling a printer perform very well with the Printer 250.

Selecting a Location for Your Printer

When selecting a location for your Printer 250, ensure it is convenient for the operator, offers adequate ventilation, and is close enough to connect the cable to your controller. Although the Printer 250 is built to operate under most conditions, a little care in selecting a location for it will help ensure trouble-free operation and a long life for the printer. Keep the following tips in mind:

- Protect your printer from direct sunlight and keep it away from excessive heat, moisture and dust.
- Place the printer on a solid foundation, but avoid setting it on a metal cabinet or table. This is especially important if your area is one where you frequently receive a static electric shock when you touch metal.
- Avoid placing your printer near devices that cause excessive voltage fluctuations or electrical noise, such as air conditioners, fans, electric motors or high-frequency security devices.
- Use a grounded outlet; don't use an adapter plug.
- Avoid stretching power or data cables; these cables should always have some slack in them. If your cables are too short, your VeriFone sales representative can assist in selecting different cables.

Unpacking Your Printer

Carefully inspect the shipping carton and its contents for damage that may have occurred during shipping. If the printer has been damaged, file a claim immediately with the shipping company or carrier and notify VeriFone, Inc. Do not use the damaged printer.

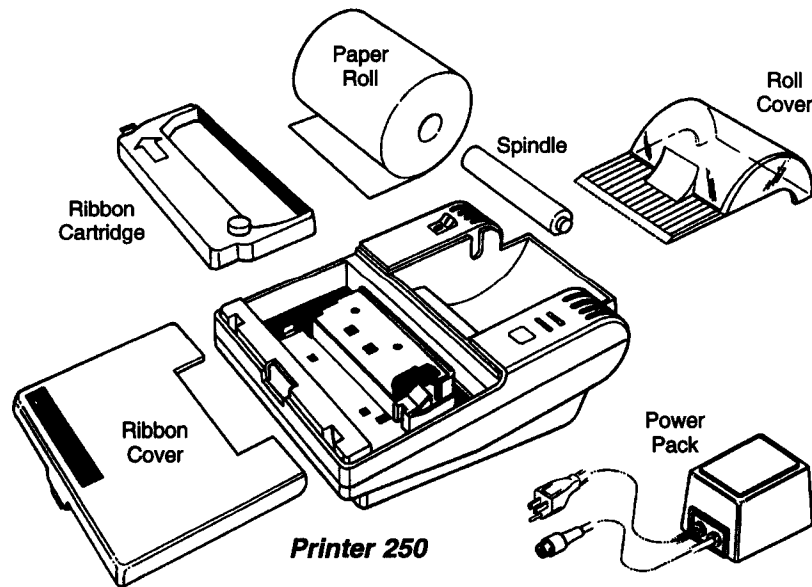

Figure 1-1. Printer 250 Components (exploded view)

1. With the shipping carton right side up, open the lid and remove the contents. As shown in Figure 1-1, you should have:
 - Printer 250
 - Power Pack
 - Ribbon Cartridge
 - Paper Roll
2. Remove any protective wrapping from the printer and cables and place all the components on the table or counter top.
3. Remove the rubber spacer and place it, with all other packing materials, back in the carton.

IMPORTANT: Save all packing materials for repacking or shipping the printer to another location.

Setting the DIP Switches

As illustrated in Figure 1-2, a set of four DIP switches is located on the inside of the printer under the ribbon cartridge. These DIP switches allow you to select the baud rate, word format (length, parity detection and generation), and operational defaults. With the ribbon cartridge removed, set the switches as indicated on the next page before connecting and operating the printer. The printer will not work properly if these switches are not set correctly.

1. Setting Up the Printer 250

CAUTION: Always disconnect the power before changing the DIP switch settings.

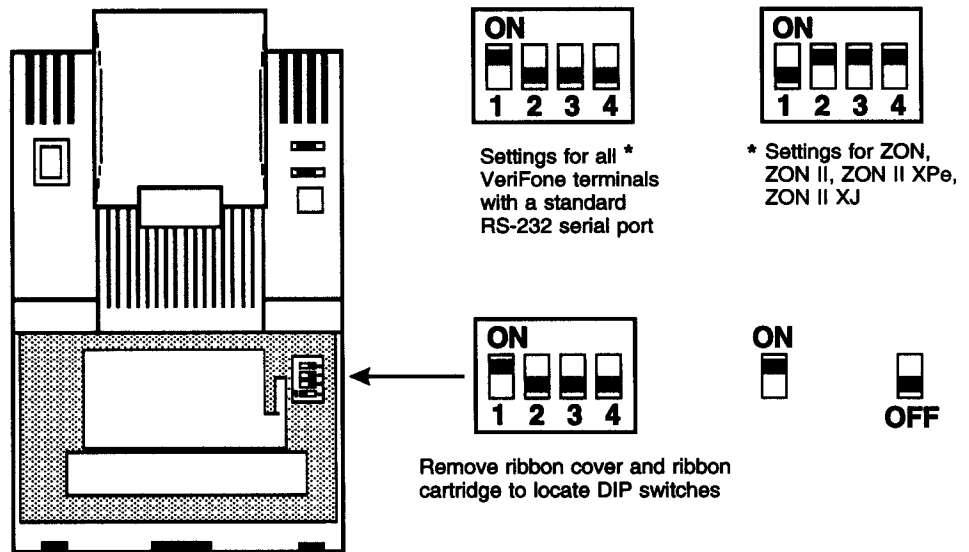

Figure 1-2. Location of DIP Switches

Switch 1	<i>Parity</i>		
	Even Parity	on	(default)
	Odd Parity	off	
Switch 2	<i>Word Length (data bits)</i>		
	7-bit word	off	(default)
	8-bit word	on	(no parity)

Switches 3 and 4	<i>Baud Rate</i>		
	Baud Rate	Switch 3	Switch 4
	1200	on	on
	2400	on	off
	4800	off	on
	9600	off	off (default)

Note: The switch settings for ZON terminals assume that the terminal is operating with its default settings. ZON parameters can only be changed by specific application programming.

Printer 250 Reference and Programmer's Manual

Installing the Printer 250

The Printer 250 connects to a VeriFone transaction terminal or other controller equipped with an RS-232 serial port. Before installing the Printer 250, verify that you have the correct printer interface cable. These cables will vary by terminal type. Consult your terminal's or controller's reference manual for the correct part number. The following is a general guideline.

Note: The interface cables listed below do not include the length specification (-XX suffix). Normally, a -00 suffix denotes a 1 meter length. For other lengths, contact your VeriFone sales representative.

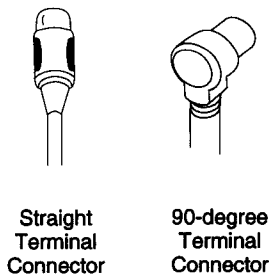

Terminal or Controller	Type of Cable	
All VeriFone terminals except for ZON, ZON II, ZON II XPe, ZON II XJ	90-degree terminal connector	10454-XX
All VeriFone terminals except for ZON, ZON II	Straight terminal connector	10448-XX
ZON, ZON II	Straight terminal connector	10512-XX
ZON II XPe, ZON II XJ	Must use straight terminal connector	10448-XX

CAUTION: Unplug the terminal's power pack before connecting the Printer 250.

Power Connection

1. Connect the 4-pin mini-DIN plug from the printer power pack to the power connector on the right-hand side of the Printer 250 rear panel.
2. Plug the Printer 250 power pack into an indoor, grounded 120 volt AC outlet. Do not install or operate the printer 250 outdoors.

Terminal Connection

3. Plug the 8-pin mini-DIN connector on the printer interface cable into the communications port on the left-hand side of the Printer 250 rear panel.
4. Plug the other end of the cable into your terminal's RS-232 port.
5. Plug in the terminal's power pack.

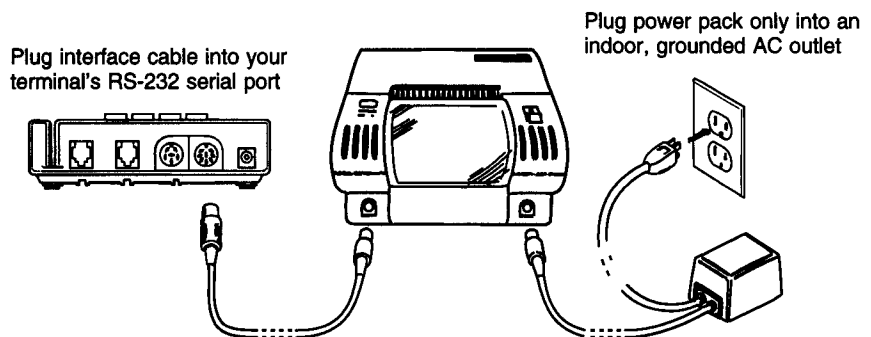

Figure 1-3. Printer Connections

Removing or Replacing the Ribbon Cartridge

Never attempt to use the Printer 250 without the ribbon cartridge. To install the ribbon cartridge, perform the following:

1. Turn off the printer power.
2. Remove the ribbon cover by pressing the front tab and lifting the cover up.
3. If you are replacing an old ribbon, lift the old cartridge out—pressing in on the left side and lifting the left side up first—and discard it.
4. Remove the new ribbon cartridge from its protective packaging and insert it, right side first, into the printer. The right edge of the cartridge will fit just outside a metal guide bar to the right. Be sure the round knob is facing up on the cartridge and that the ribbon fabric fits between the print head and the ribbon guide.
5. Press the left side of the ribbon cartridge into place. If it does not fit easily, lift the cartridge out and try again. Do not force the cartridge into place.
6. Turn the small knob on the cartridge clockwise to remove any slack.
7. Insert the two tabs on the rear of the ribbon cover into the slots on the printer.
8. Press the front of the cover down and snap into place.

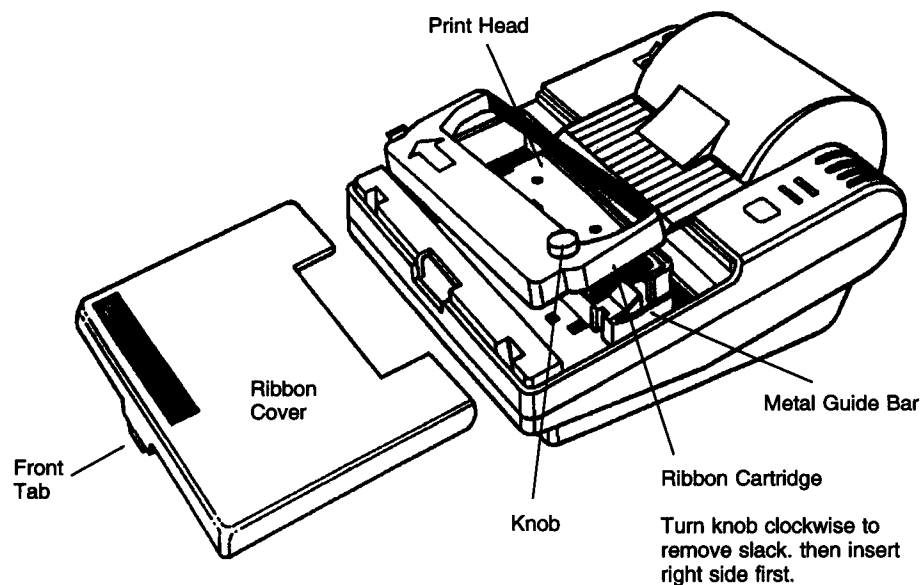

Figure 1-4. Installing the Ribbon Cartridge

Installing the Paper Roll

The Printer 250 accepts paper rolls with either 11 mm or 17 mm diameter cores. There are four different types of roll paper available from VeriFone. These are listed by part number under *Paper Specifications* in Section 4.

Note: For best results, be sure that the leading edge of the paper roll is cut cleanly rather than torn before feeding it into the printer. This is particularly important when inserting multiple-part paper.

1. Remove the paper roll cover by pressing the tab at the rear of the cover and lifting up.
2. Press down the "I" symbol on the power switch to turn the printer on.
3. With the paper feeding from the bottom of the roll (see Figure 1-5), guide the end of the paper roll into the metal paper slot on the printer. While feeding the end of the paper into the slot with one hand, hold the paper feed button down until the printer grabs the paper.
4. Insert the paper roll spindle into the roll of paper.
5. Insert the spindle with the attached paper roll into the roll cavity. The ends of the spindle must fit into the slots on the sides of the cavity.
6. Hold down the paper feed button until about two inches of paper emerges from the printer.
7. Replace the paper roll cover on the printer by inserting the two front tabs first and then snapping the cover downward. Ensure that the paper extends through the slot on top of the printer.

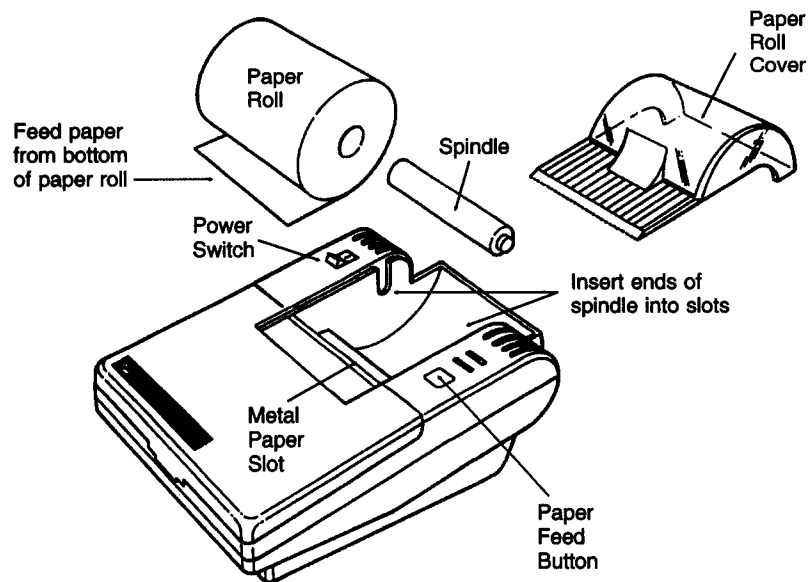

Figure 1-5. Installing the Paper Roll (exploded view)

1. Setting Up the Printer 250

Removing the Paper Roll

CAUTION: If you must remove a paper roll from the printer, do not pull the paper out from the rear of the printer. This could damage the feed mechanism.

1. Cut or tear the paper from the rear of the printer and place the paper roll aside.
2. Use the paper feed button to remove the stub remaining in the feed mechanism.

Running the Print Test

1. Turn the power switch off.
2. Hold down the paper feed button and turn the power switch back on. The test will run continuously until the printer is turned off.

Maintenance

The Printer 250 requires minimal maintenance to keep it in peak operating condition. By observing the following maintenance and inspection routines you will prevent potential problems and ensure a long product life.

Cleaning

CAUTION: Never use thinner, trichloroethylene, or ketone-based solvents to clean the printer as they may damage plastic parts.

1. Remove dirt using a clean cloth dampened with water and mild soap. Stubborn stains can be removed using alcohol.
2. If necessary, use a small vacuum cleaner to remove paper particles and dust from the inside of the printer.

Periodic Check

Perform regular maintenance and inspection of the points listed below every six months or every 1,500,000 printed characters.

- *Adhesion/penetration of Dirt, Scraps or Dust to the Printer Parts*
Use a vacuum cleaner or tweezers to carefully remove all foreign matter from the printer.
- *Ribbon Cartridge*
Ensure the ribbon cartridge is securely installed in the printer. Ensure only the specified ribbon cartridges are used, and that the ribbon is not twisted or damaged.
- *Printing and Operations*
Ensure there are no abnormalities in the printing, paper feed, and ribbon feed operations. Observe each function and check for malfunctions due to wear, deformation or warping of the parts.

Printer 250 Reference and Programmer's Manual

2. Printer 250 Basics

Control Panel

As shown in Figure 2-1, the Printer 250 control panel includes two indicator lights: POWER and PAPER LOW; one button: FEED; and one switch: Power On/Off.

- **POWER Light**— This green light illuminates when the printer has power; the printer will only operate when this indicator light is on. An error condition is signaled when this indicator light changes from steady to flashing.
- **PAPER LOW Light** — This amber light illuminates when the sensor determines the unit has 20% or less of a full paper roll remaining.
- **FEED Button** — Pressing this button once manually feeds one line of paper. Holding down this button feeds paper continuously until the button is released.
- **Power On/Off Switch** — This switch is used to turn the power on and off. The "I" position is on, and the "O" position is off.

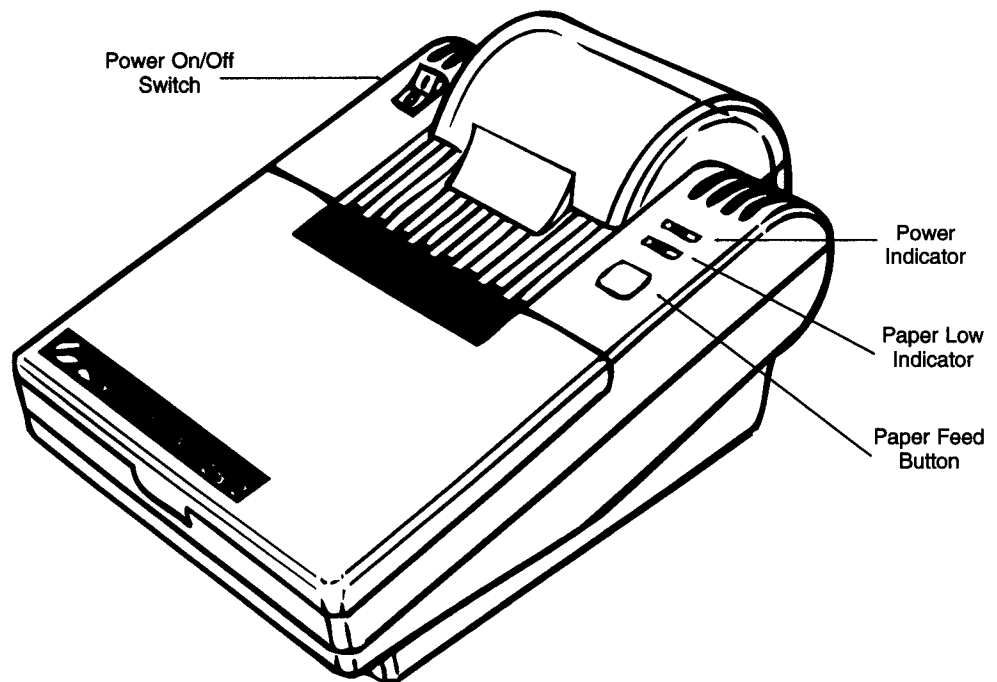

Figure 2-1. Printer 250 Control Panel

Printer 250 Reference and Programmer's Manual

Printer Features

The Printer 250 provides enhanced characters, such as double width, double height, and double width-double height. It has the ability to print on single-part, two-part, or three-part roll paper. Printing is possible in either red or black ink. An external power pack is provided to remove weight and bulk from the actual printer enclosure.

Command Set

The Printer 250 offers two modes in which text data may be presented and subsequently printed: the Printer 200 Emulation mode and the Native mode. The Printer 200 Emulation mode is the default condition on power-up. The Native mode can only be used after being activated by the Enable Native Mode sequence.

As described in Section 3, *Printer 250 Commands*, certain commands operate differently in the Native mode than in the Printer 200 Emulation mode, particularly the functions of the SI, SO, RS, US, and DC2 commands. Also, certain commands are modified by selection of the serial communication format, specifically the SI and SO codes.

Depending on the selected mode, the ESC e (n) command determines whether or not printing will occur when the buffer is filled and at what position on the line. In the Printer 200 Emulation mode, the buffer is automatically printed when the 40th character on a line is received. In the Native mode, the default truncates characters after the 42nd character position, and then prints only on receipt of the New Line (LF) command. If the parameter "n" is between 1 and 42, inclusive, the printer automatically prints the line upon receipt of the nth printable character. For values outside of that range, lines are truncated to 42 characters and are printed only on receipt of the LF command.

The Printer 250 also provides a dot graphics mode in which the host terminal has almost complete control over the print mechanism and can print dots in full or half-dot positions in either red or black. In this mode the printable characters are subdivided into two group of characters: printable bit patterns and terminators. The wide variety of line terminators determine the way in which the received bit patterns are printed.

Printable Characters

The Printer 250 can print the complete, normal ASCII character set, plus several characters required by European languages. Selection of these various character sets is made using the ESC h and SI commands.

Printable characters are defined as those with codes from 20h to FFh, inclusive, excluding the DEL code which is used internally as an escape character for double-width characters. To prevent the DEL code from being misinterpreted, it is replaced by the space character when it is encountered.

When a printable character is received, it is placed in a print buffer and the buffer pointer is increased by one or two, depending on whether the double-width mode is active. If incrementing the buffer pointer would cause it to exceed the right margin, the line is automatically printed.

Some codes from 20h to 7Eh may be remapped depending on the currently selected country so that certain characters in that range will not print as their ASCII equivalents in some countries. In particular, international applications should avoid using the following:

- The "#" sign instead of an appropriate abbreviation for "number"
- Use of any of the following special characters: { [] } | ~ ' \

Character Set and Font Data Organization

Logically, the character set is viewed as 96 ASCII codes and 32 alternates, plus 128 high-page characters. Physically, the character set is stored as a sequence of contiguous sectors of 256 bytes each. Each of the first 7 sectors constitutes a row of font data, and the last contains the country code map. Within each row, the byte corresponding to the image code is the horizontal data for that image code and row.

Each odd bit corresponds to a full-dot position, with bit 7 being the leftmost bit and bit 1 being the rightmost. Bit 0 is normally left blank; however, if used, it corresponds to the half-dot position on the right edge of the character. (This can come in quite handy if you've ever tried to construct the ligature of "ae" in 7 dots.)

The country code map consists of a code vector and 16 individual mapping tables. The code vector, occupying the first 96 bytes, either contains itself or a number greater than or equal to 96. In the former case, the character is considered to be unmapped. In the latter case, the contents of the vector at that position plus the country code minus one is the offset into an individual mapping table, at which is stored the address of the replacement image code.

The first 32 image codes, inaccessible to the normal software, are used to hold the international substitution characters.

Error Detection and Recovery

Conditions such as data overrun, framing, and parity errors cause all offending characters to be discarded.

If a mechanism failure is detected, the POWER indicator light will flash off and on until the printer is powered down and then turned on again. In the Native mode, the printer can be reset by issuing the ESC c command, followed by the ESC d command. In the Printer 200 Emulation mode, the printer must be powered down to clear the condition.

Printer 250 Reference and Programmer's Manual

3. Printer 250 Commands

Command	Description	Page
<i>Execution Commands</i>		
LF	Print Buffer Contents	3 - 2
FF	Eject Paper	3 - 2
DC2	Change Ribbon Color	3 - 3
CAN	Empty Print Buffer and Cancel Character Attributes	3 - 3
ESC a (n)	Set Line Height to "n" Dots	3 - 3
ESC b (n)	Eject Paper "n" Lines	3 - 4
ESC c	Reset Printer to Power-Up State	3 - 4
ESC d	Request Printer Status	3 - 4
FS	Enter Native Mode	3 - 4
GS	Enter Printer 200 Emulation Mode	3 - 5
NUL	Pad Character	3 - 5
<i>Advanced Commands</i>		
RS or SO	Double-Width Mode or Select High-Page Graphics	3 - 5
US or SI	Normal-Width Mode or Select ASCII Character Set	3 - 6
ESC e (n)	Set Right Margin	3 - 6
ESD f (n)	Select Line Attribute	3 - 7
ESC i	Printer Identification	3 - 7
ESC r (n)	Retrieve Printer Information	3 - 7
ESC l (n)	Download Character	3 - 8
<i>Print Mode Commands</i>		
ESC g	Activate Dot Graphics Mode	3 - 9
ESC h (n)	Select Character Set	3 - 11
ETX	Select Cyrillic Font	3 - 11

This section includes a description of the commands available for the Printer 250. Each command includes a format section and comments section. The format section provides the ASCII and hexadecimal codes for the command, and the comments section provides a brief explanation of the command and any variables in the command line. The letter "n" indicates a variable that is explained in the comments section.

Certain escape sequences consist of only the <ESC> command followed by a single command character (for example, ESC g). These commands should be used "as is." Others require additional parameters. For those, the number

Printer 250 Reference and Programmer's Manual

of parameter characters must only be sufficient to represent the required value. If a value is less than 10, a single parameter character (n) is sufficient; a parameter of 10 to 99 requires two characters (n n), etc. Whenever parameters are used, the escape sequence must be terminated by a semicolon.

There are two possible modes in which the Printer 250 can operate: the Printer 200 Emulation Mode and the Native Mode. When the printer is first powered up the default is to emulate the Printer 200. Native Mode commands can only be used after being activated by the Enable Native Mode command. Certain commands operate differently in the Native Mode, particularly the SI, SO, RS, US, and DC2 commands.

Important: None of the escape sequences are valid in the Printer 200 Emulation Mode. To use an escape sequence, ensure you are first in the Native Mode.

Execution Commands

Execution commands cause the printer to perform a print or paper movement operation.

LF **Print Buffer Contents**

Format	ASCII: LF
	HEX: 0A
Comments	This command prints the contents of the print buffer on the current line and advances the paper one line. After printing is completed, the command returns the print position to the left margin and clears the print buffer. This is the standard command for printing a line of text.

Note: In the Printer 200 Emulation mode, the LF command is ignored when it immediately follows printing of a full buffer.

FF **Eject Paper**

Format	ASCII: FF
	HEX: 0C
Comments	This command prints the contents of the print buffer and ejects one inch of paper, regardless of the setting of the current line height. This command ensures that the last line of text is visible and will be included on the receipt when it is torn off.

DC2 Change Ribbon Color

Format	ASCII:	DC2
	HEX:	12
Comments	This command changes the currently selected ribbon color from red to black or vice-versa (if a two-color ribbon is being used, otherwise it has no effect). The line always starts with the ribbon color set to black. When the line is printed in the Printer 200 Emulation mode, the entire line is printed in the color selected at the time the line feed or full buffer printing occurs. In the Native mode, characters received when the selected color was red are printed in red, and characters received when the selected color was black are printed in black. Printing two colors on the same line is only possible in the Native mode.	

CAN Empty Print Buffer and Cancel Character Attributes

Format	ASCII:	CAN
	HEX:	18
	<i>Note: The CAN command is ignored if the printer has already begun printing from the print buffer.</i>	
Comments	This command clears the contents of the print buffer without printing, the color attribute is reset to black if red had been selected, and all other attributes are reset to their inactive or default conditions.	

ESC a (n) Set Line Height to "n" Dots

Format	ASCII:	ESC	a	n	;
	HEX:	1B	61	3x	3x3B
	where n = any number from 0 to 9 (30h to 39h), and the semicolon is required				
	For example:	a	0...9	0...9;	
		61	30-39	30-39	3B
Comments	This command establishes the height of each printed line, where each dot line is 1/60th of an inch. The parameter (n) must be at least 7 and less than 256. A value of 10 corresponds to 6 lines per inch. The minimum value of 7 corresponds to approximately 8.6 lines per inch, with no space between lines. The default line height is 10 dots.				

Printer 250 Reference and Programmer's Manual

ESC b (n) Eject Paper "n" Lines

Format ASCII: ESC b n n;
 HEX: 1B 62 3x 3x3B

where n = any number from 0 to 9 (30h to 39h), and the semicolon is required

Comments This command causes the printer to eject "n" lines of the currently specified height. The length of paper ejected is determined by (Number of Lines * Line Height) / 60. A value of 0 is ignored; the maximum value is 255.

ESC c Reset Printer to Power-Up State

Format ASCII: ESC c
 HEX: 1B 63

Comments This command is the software equivalent of turning the power switch on and off (toggling). All modes are reset to their default states (including the Printer 200 Emulation mode).

ESC d Request Printer Status

Format ASCII: ESC d
 HEX: 1B 64

Comments This command causes the printer to respond with a one-byte status message, as follows:

 P F 1 X X X X L

where:

 L = Paper level low
 X = Reserved
 1 = Always high
 F = Mechanism failure occurred
 P = Parity (as defined by word format)

FS Enter Native Mode

Format ASCII: FS
 HEX: 1C

Comments This command resets all attributes, clears the print buffer, and sets the right margin to 0. All subsequent commands and printer operations are treated according to their Native mode interpretations.

GS Enter Printer 200 Emulation Mode

Format	ASCII: GS
	HEX: 1D
Comments	This command resets all attributes, clears the print buffer, and sets the right margin to 40. All subsequent commands and printer operations are treated according to their Printer 200 Emulation mode interpretations. Escape sequences are not valid in this mode.

NUL Pad Character

Format	ASCII: NUL
	HEX: 00
Comments	<p>This command is used to pad characters at the end of a line or between printable characters on the same line. The Pad Character command is only provided to accommodate terminals or other controllers which do not support the Printer 250 hardware handshake. All VeriFone terminals—and many others—do support the handshake and do not require use of the pad character.</p> <p>The number of pad characters required at the end of each line is approximately $(\text{Baud Rate} * \text{Line Height in dot rows}) / 160$. The number of pad characters required between printable characters on the same line is approximately $\text{Baud Rate} / 2400$; for line feed $(\text{Baud Rate} * (\text{Line Height} / 4) + 2) / 160$.</p>

Advanced Commands The following commands are used to select advanced functions of the Printer 250.

RS or SO Double-Width Mode or Select High-Page Graphics

Format	ASCII: RS
	HEX: 1E
Comments	<p>This command causes all characters following the command to be treated as double-width characters. If there is only one character position remaining on the line, the character will be printed in the normal width. This attribute remains active until the US command (cancel double width) or the CAN (cancel) command is received. In the Printer 200 Emulation mode, this attribute is reset to normal at the start of each line.</p> <p>For the Printer 250 Slavic model, the SO command selects the Slavic characters, located in the high-page graphics range A1h to EAh. The SI command cancels the effect of the SO command. See Appendix B for the character images of the Slavic font.</p>

Printer 250 Reference and Programmer's Manual

Format	ASCII:	SO
	HEX:	0E
Comments	This command is modified by both the operation mode (Printer 200 Emulation or Native mode) and the serial character format. In any of the 7-bit modes, this command replaces the codes from 20h to 7Eh with the codes from A0h to FEh. When 8-bit data is selected, this command is ignored when the printer is in the Native mode and is interpreted as RS (set double width) when the printer is in the Printer 200 Emulation mode.	

US or SI Normal-Width Mode or Select ASCII Character Set

Format	ASCII:	US
	HEX:	1F
Comments	This command causes the printer to explicitly reset the double-width attribute. Characters received before this command will be printed double wide, however, characters that follow will not.	
Format	ASCII:	SI
	HEX:	0F
Comments	This command is modified in a manner similar to the SO command. When both the 8-bit and Printer 200 Emulation modes have been set, the command is interpreted as US (cancel double width). In the 7-bit mode, it cancels the effect of the SO command (select high-page graphics). For the Printer 250 Slavic model, the SI command cancels the effect of the SO command.	

ESC e (n) Set Right Margin

Format	ASCII:	ESC	e	n	n;
	HEX:	1B	65	3x	3x3B
	where n = any number from 0 to 9 (30h to 39h), and the semicolon is required				
Comments	The right margin setting controls whether or not printing will occur when the print buffer is filled, and at what position on the line. In the Printer 200 Emulation mode, the buffer is automatically printed when the 40th character on a line is received. In the Native mode, the default truncates characters after the 42nd character position, and prints only on receipt of the new line (LF) command. If the parameter (n) is between 1 and 42, inclusive, the printer automatically prints the line on receipt of the nth printable character. For values outside of this range, lines are truncated to 42 characters and are printed only when the LF command is received.				

ESC f (n) Select Line Attribute

Format ASCII: ESC f n n;
 HEX: 1B 66 3x 3x3B

where n = any number from 0 to 9 (30h to 39h), and the semicolon is required

Comments This command is used to select attributes which must be applied to an entire line at one time. Character-by-character attributes, such as normal or double width, high-page graphics, ASCII characters, etc., are set by the SO, SI, RS, and US commands. The legal values and their corresponding attributes are as follows:

Value	Description
0	Normal
1	Double Height
2	Reserved
3	Reserved

Note: This command must be cancelled using either the ESC c or ESC f 0 command.

ESC i Printer Identification

Format ASCII: ESC i
 Hex: 1B 69

Comments This command is a printer verification query. The Printer 250 responds with an uppercase "A." Any other character is invalid for the Printer 250.

ESC r (n) Retrieve Printer Information

Format ASCII: ESC r n;
 Hex: 1B 72 3x3B

where n = any number from 0 to 5 (30h to 35h), and the semicolon is required

Comments This command is only valid for the Printer 250 with part number P002-113-19. The part number can be found on the bottom of the printer. This command retrieves information according to the following table:

Printer 250 Reference and Programmer's Manual

Value	Description	Example of Format
0	Retrieve all of the following data (1-5)	
1	Printer Model	"P250"
2	Serial Number	"123-456-789"
3	Hardware Version	"D"
4	Software Version	"AC41011"
5	Checksum of ROM	"2B7D"

Example: <ESC>r0; sends all of the data to the host

ESC I Download Character

Format	ASCII:	ESC	l	f	c	n ¹ . . . n ⁸ ;
	HEX:	1B	6C			3B
Comments	See the following for parameter definitions, and the semicolon is required					
	This command (<ESC> lowercase L) is only valid for buffered and other specific versions of the Printer 250. Presently, these include part numbers:					
		P002-113-07			P002-113-19	
		P002-113-08			P002-113-21	
		P002-113-13			P002-113-27	
		P002-113-14			P002-113-29	
		P002-113-18			P002-113-31	

The part number can be found on the bottom of the printer.

The ESC I command sends a customized character to the printer. Customized characters are bit-mapped images of whatever character you wish to create, within limitations. You might use this command to create a special alphanumeric character, a symbol, or a graphic.

This command is only valid in the Native mode, and the character(s) will be erased upon power up, issuance of the FS or GS commands, or ESC c. While this command may be used innumerable, the printer can only contain three customized characters at one time. If a fourth customized character is sent, it will replace the first customized character. If a fifth customized character is sent, it will replace the second customized character, etc.

The parameter "f" is the font code and is always ignored (a "0" is sent). The "c" parameter is the character code, is one-byte long and may have a value between 21h and 7Eh. Note that this character code will replace its equivalent in the original font. For example, if you customize the letter "b" to print a box instead of the letter "b", then any time you send a "b" a box will be printed. Remember that this command may be used and then erased with the methods discussed in the previous paragraph.

3. Printer 250 Commands

The "n" parameter is eight-bytes long and conforms to the following table:

Byte	Usage
n ¹	Row 1 font data
n ²	Row 2 font data
n ³	Row 3 font data
n ⁴	Row 4 font data
n ⁵	Row 5 font data
n ⁶	Row 6 font data
n ⁷	Row 7 font data
n ⁸	Reserved; "00" is sent

A character comprises seven rows, with eight dots in each row. Dots may not be adjacent. For example, 10101010 is allowable, but 10110100 is not.

The following illustrates a "box" character assigned to the letter "b":

Command: ESC | 0 b <55h> <41h> <41h> <41h> <41h> <41h> <55h> <00> ;

Mapping:	Row 1	0	1	0	1	0	1	0	1	10h
	Row 2	0	1	0	0	0	0	0	1	10h
	Row 3	0	1	0	0	0	0	0	1	10h
	Row 4	0	1	0	0	0	0	0	1	10h
	Row 5	0	1	0	0	0	0	0	1	10h
	Row 6	0	1	0	0	0	0	0	1	10h
	Row 7	0	1	0	1	0	1	0	1	10h

Print Mode Commands

The following commands are used to establish the print mode and select print options, such as font, print size, character set, and so forth.

Note: In the graphics mode, all other control codes will cause the following conditions to occur:

1. All outstanding graphics data will be discarded.
2. The graphics mode will be cancelled.
3. Normal functions of the control code will be performed.

ESC g Activate Dot Graphics Mode

Format	ASCII:	ESC	g
	HEX:	1B	67
Comments	This command causes the printer to enter a mode in which printable characters are treated as graphic images. The printable characters are subdivided into two groups of characters: printable bit patterns and terminators. The wide variety of line terminators determine the way the received bit patterns will be printed.		

Printable Images

Graphic images are constructed one dot line at a time in up to four passes, depending on the resolution and number of colors requested. For example, to print one horizontal line of a two-color, 160-dot-per-inch (dpi) image requires one pass to print all of the black dots in positions 1, 3, 5, 7 ... 419, another pass to print all of the red dots in those positions, followed by another pass to print the black dots in positions 2, 4, 6, 8 ... 420, and then one final pass in which the red dots are printed and the paper is fed.

The actual data for the image is presented sequentially in 6-bit increments. Bit 7 depends on parity, bit 6 is always 1, and the remaining bits are the graphic image bits. Of the remaining bits, bit 5 is the leftmost bit and bit 0 is the rightmost. The first code sent represents the leftmost carriage position, the last character the rightmost, etc.

Note: The 160-dpi graphic images are printed as two interleaved 80-dpi images, and only odd or even positions can be printed on any one cycle and in only one color at a time.

Graphic Line Terminators

After the graphic data has been loaded in the buffer, the dot line portion can be printed by sending a terminating character constructed as shown below. To exit the graphic mode without printing, execute the CAN command. It is not necessary to completely fill the graphic buffer (buffer capacity = 35 bit image codes) in order to print. The rightmost positions are initially blank.

P 0 1 Res Exit Odd Red Feed

where:

Feed = 1 = Dot line feed

Red = 0 = Black; 1 = Red

Odd = 0 = Positions 2, 4, 6, 8 ... 420;
Positions 1, 3, 5, 7 ... 419

Exit = 1 = Leave graphics mode when finished

Res = 0 = Reserved

1 = Always 1

0 = Always 0

P = Parity (as defined by word format)

The graphics mode is cancelled when any control character or escape sequence (ESC) command is received. When this occurs, the buffer is cleared, all mode flags are reset to their default state, and the command that terminated the graphic mode is executed normally.

ESC h (n) Select Character Set

Format ASCII: ESC h n n;
 HEX: 1B 68 3x 3x3B

where n = any number from 0 to 9 (30h to 39h), and the semicolon is required

Comments This command is valid for text printing only, and is used to select different font and character sets according to the value of (n). The n variable may have one of the following values:

Value	Country
0	United States
1	France
2	Germany
3	United Kingdom
4	Denmark I
5	Sweden
6	Italy
7	Spain
8	Japan
9	Norway
10	Denmark II

ETX Select Cyrillic Font

Format ASCII: ETX
 HEX: 03

Comments This command is only valid for the Printer 250 Cyrillic model.

Issuing this command accesses the Cyrillic characters, located in the high-page graphics range A0h-BFh. See Appendix C for the character images of the Cyrillic font.

To cancel the command, select the command SI (select ASCII character set), or the command SO (select standard high-page graphics).

Example:

<ETX>123ABC456<SI>7890

This will print "123" as Cyrillic characters (B1h, B2h, B3h), "ABC" are out of the Cyrillic characters range so they will be mapped to the standard high-page graphics (C1h, C2h, C3h), "456" will be Cyrillic characters (B4h, B5h, B6h), and "7890" will be ASCII characters.

Printer 250 Reference and Programmer's Manual

4. General Specifications

Printer	Print Method:	7-pin, shuttle impact dot-matrix
	Print Direction:	Uni-direction (right to left)
	Print Width:	65.84 mm, 210 dots 42 columns/line at 8 x 7 half-dot font in 5 x 10 dot cell for normal text 21 columns/line enlarged
	Footprint:	310.2 sq cm (48.1 sq in)
	Paper Feed Speed:	Approximately 1.8 lines/second minimum
	Print Speed:	Approximately 92 characters/second (2.1 lines/second by actual experiment)

Note: Print speed varies, depending on the data transmission speed and combination of control codes.

Character Set and Size	Character Set:	96 ASCII characters (7 x 7 fonts) 32 graphic characters 128 international characters: 96 in high page 32 internal
	Character Size:	1.3 mm (W) x 2.9 mm (H) (7 x 7 font) 2.6 mm (W) x 2.9 mm (H) (7 x 7 font, enlarged)

Column and Line Spacing	Column Spacing:	0.63 mm (7 x 7 font) 1.26 mm (7 x 7 font, enlarged)
	Line Spacing:	4.23 mm (1/6 inch) default Programmable in units of 1/60 inch (0.42 mm)

Paper Specifications	Paper Types:	Normal paper Pressure-sensitive paper Multi-sheet (1 original + 2 copies)
	Total Thickness:	PN CRM0008 Roll, 1 ply, 17 mm core PN CRM0008-01 Roll, 2 ply carbonless, 11 mm core PN CRM0008-02 Roll, 3 ply carbonless, 11 mm core PN CRM0008-03 Roll, 1 ply, 11 mm core

Printer 250 Reference and Programmer's Manual

Copy Capability: Temperature impacts the ability to print on multi-ply paper or forms. Printing should be performed within the following temperature ranges:

<u>Number of Copies</u>	<u>Temperature</u>
Original + 2 copies	Average 25° C
Original + 1 copy	5°C to 40°C

Inking

Method: Ribbon Cartridge
Color: PN CRM0009-03 Red and black (dual-color ribbon)
PN CRM0009-02 Purple (optional single-color ribbon)
Dimensions: 122 mm (W) x 64 mm (D) x 20.8 mm (H)
Life Expectancy: 0.75 million characters per color (approx. 1 month)
Ribbon Type: Epson ERC-23

Case Dimensions and Weight

Height: 105 mm (4.13 in)
Width: 155 mm (6.1 in)
Depth: 225 mm (8.86 in)
Weight: 1.37 kg (3 lbs), including full roll of paper

Electrical Specifications

Power Supply: 24VDC +/-10%
Power Consumption:
Operating: 1 A @ 24 VDC
Non-operating: 100 mA

Environmental Specifications

Temperature:
Operating: 0°C to 40°C
Storage: -10°C to 50°C
Humidity:
Operating: 10% to 90% relative humidity, no condensation
Storage: 30% to 90% relative humidity, no condensation

Power Supply Unit

Input Voltage: 110 volts to 120 volts AC, 60 Hz
Output Voltage: 24 VDC
Power Consumption: 20 watts (average), 31 watts (peak)
Dimensions: 180 mm (W) x 190 mm (D) x 52 mm (H)
Casing: Plastic, black

Serial Interface

RS-232C Compatible
Synchronization: Asynchronous
Handshaking: By RTS signal
Signal Level: MARK = logic 1 = -3V to -15V
SPACE = logic 0 = +3V to +15V
Stop Bits: One or more bits, receive mode
One bit, transmit mode

4. General Specifications

Connector Pin Assignments:

Table 4-1: Pinouts for Serial Connector

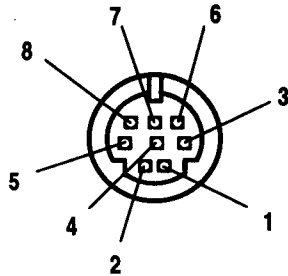

Pin No.	Signal	Direction	Function
1			No connection
2			No connection
3	RTS	Out	OK for printer to receive data = SPACE OK for printer to transmit data = SPACE
4	CTS	In	Transmitting data
5	RxD	In	Receiving data
6	TxD	Out	Transmitting data
7	GND	—	Signal ground
8			No connection

Note: "Out" indicates a signal generated by the Printer 250 while "In" indicates a signal required by the printer for proper operation.

The Printer 250 performs data flow control using the RTS hardware handshake (pin 3). It will hold RTS high whenever it can accept commands or data, and lower RTS when it cannot. It will also buffer data received within 20 ms after lowering RTS to prevent loss of print data or commands.

Appendix A: Standard Character Set

Character Codes All 256 character codes are supported. The first 32 (00h - 1Fh) are reserved for country-specific ASCII substitutions. The next 96 (20h - 7Fh) are the U.S.A. ASCII characters. The remaining 128 (80h - FFh) are available in the 8-bit data mode.

Note: Code 127 (7Fh) is always replaced by the space code (20h) and is therefore never printed.

Fonts The font images do not follow a strict style, that is, some images are serifed, while others are not. This is done to enhance readability since the character matrix is small, and resolution is limited.

Font images are generally contained in a matrix four dots wide by seven dots tall; seven dots being the height of an uppercase character, and five dots being the height of a lower case character. Width is normally limited to three or four dots, but occasionally four-and-a-half dots must be used. Because of the limited width, half-dot positions are used, where possible, to improve character readability.

Driver This typeface works with the 7x7 draft quality driver and occupies 2k bytes of microcontroller ROM. With this combination of driver and typeface, the following attributes are supported:

- 255 unique printable images
- Double- and normal-width characters on the same line
- Print speed of three lines per second
- Draft quality

Files The following files are required to support this typeface:

File Name	Description
ISO7X7.FON	Binary Font Image Data
ISO7X7.ASM	Source Code Output from Font Utility
CCMAP.ASM	Country-Dependent Substitution Table

Country-Dependent Codes

Depending on the country selected, some characters normally assigned to printable ASCII codes will be replaced with other characters specific to that country. Usually, these characters are the most commonly used accented vowels. In other cases, these may be country-dependent currency symbols.

The following table shows all of the substitutions for the specified country. The top line lists the character codes affected. See Appendix B for the Slavic character set.

Country	23	24	40	5B	5C	5D	5E	60	7B	7C	7D	7E
U.S.A.	#	\$	@	[\]	^	'	{		}	~
France	#	\$	à	°	ç	§	^	'	é	ù	è	..
Germany	#	\$	§	Ä	Ö	Ü	^	'	ä	ö	ü	ß
United Kingdom	£	\$	@	[\]	^	'	{		}	~
Denmark I	#	\$	@	Æ	Ø	Å	^	'	æ	ø	å	~
Sweden	#	¤	É	Ä	Ö	Å	Ü	é	ä	ö	å	ü
Italy	#	\$	@	°	\	é	^	ù	à	ò	é	ì
Spain	Pt	\$	@	¡	Ñ	¿	^	'	..	ñ	}	~
Japan	#	\$	@	[¥]	^	'	{		}	~
Norway	#	¤	É	Æ	Ø	Å	Ü	é	æ	ø	å	ü
Denmark II	#	\$	É	Æ	Ø	Å	Ü	é	æ	ø	å	ü

Font Images

The following pages show the actual font images and their associated codes in true aspect. Each font is printed in a character cell 5 dots wide and 7 dots tall. Full dot positions correspond to spaces between grid lines and half dot positions are those which sit upon the grid lines.

Printer 250 Reference and Programmer's Manual

Font Image Codes 2Ah to 53h

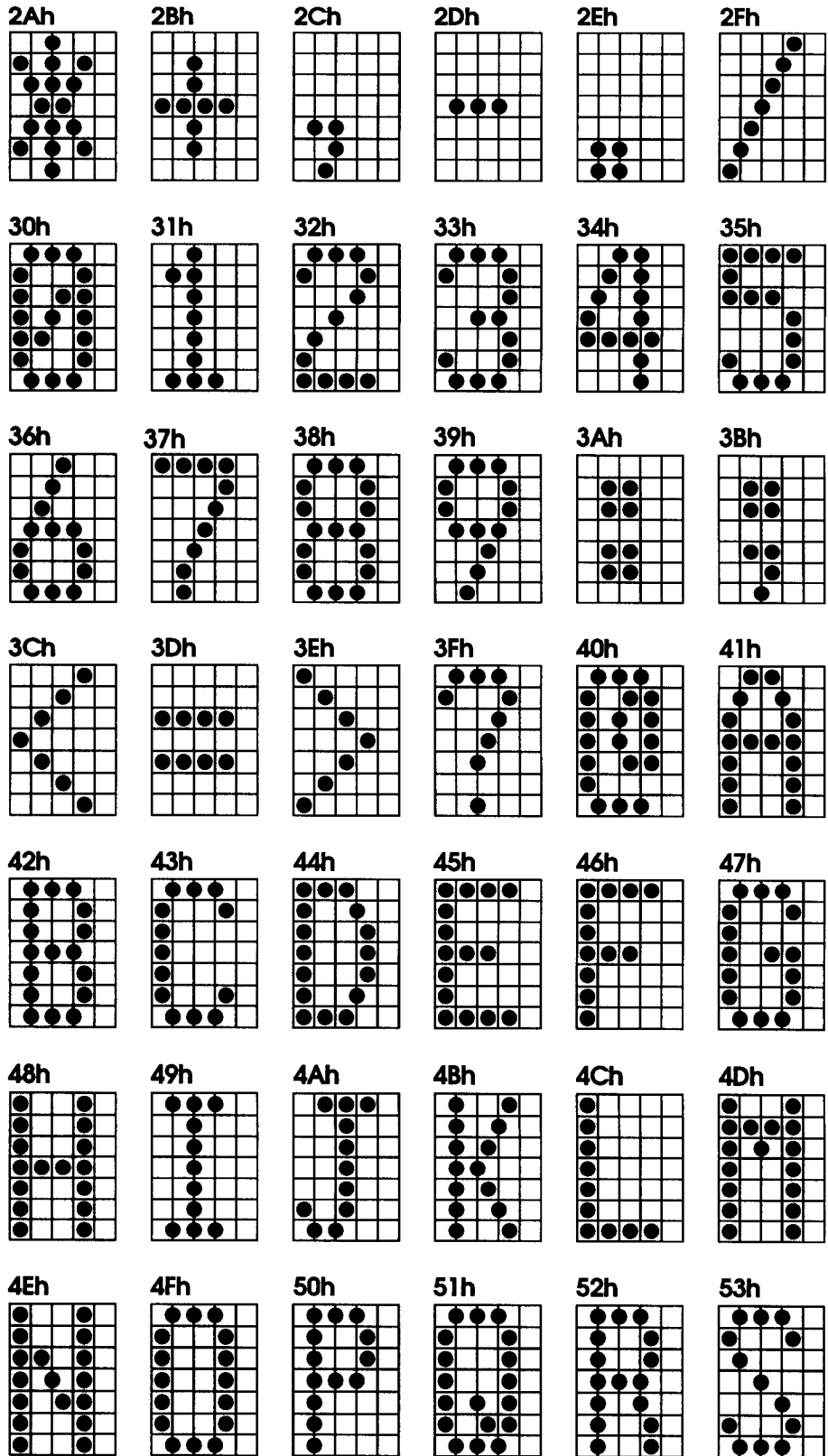

Appendix A: Standard Character Set

Font Image Codes
54h to 7Dh

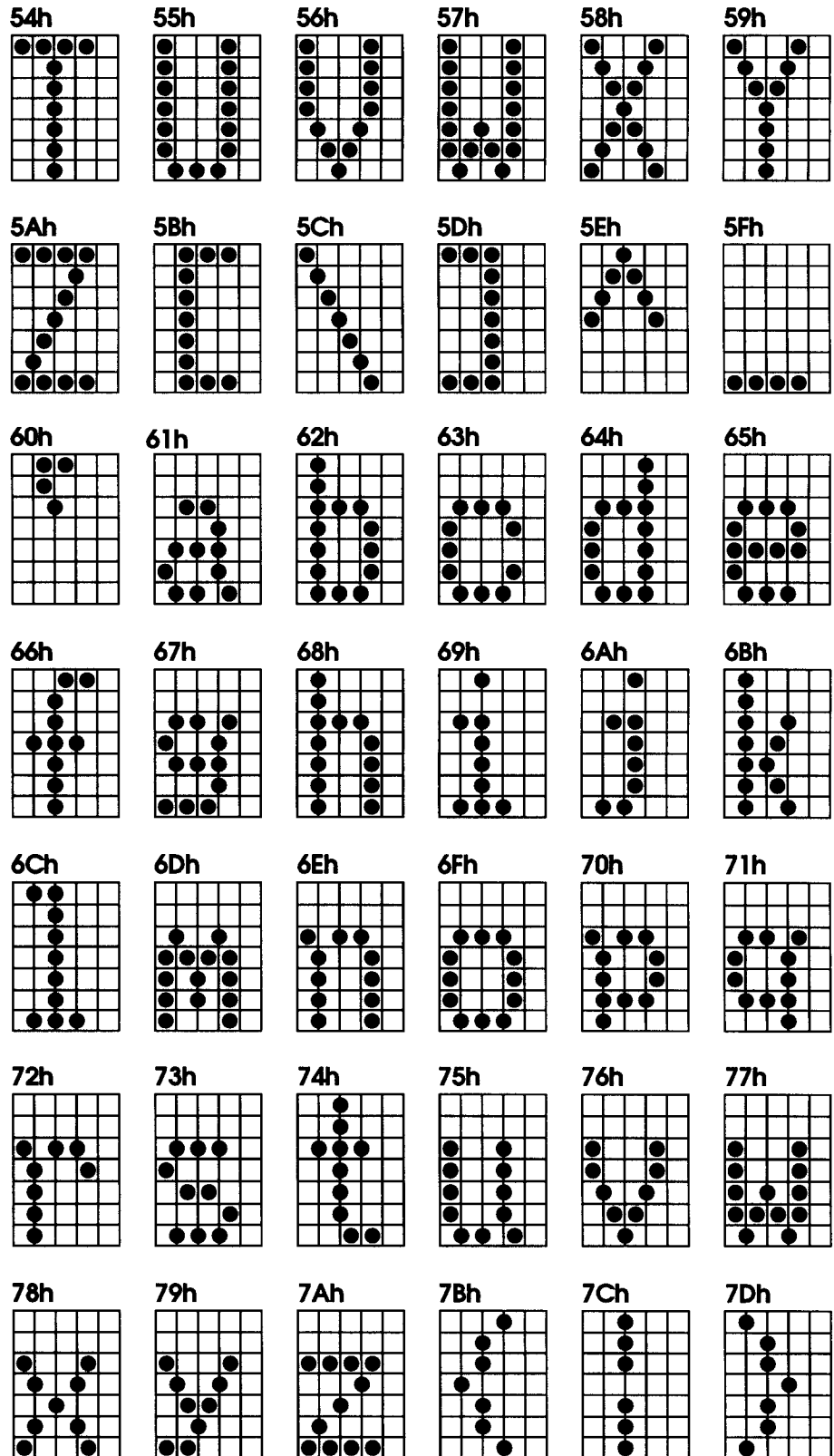

Printer 250 Reference and Programmer's Manual

Font Image Codes 7Eh to A7h

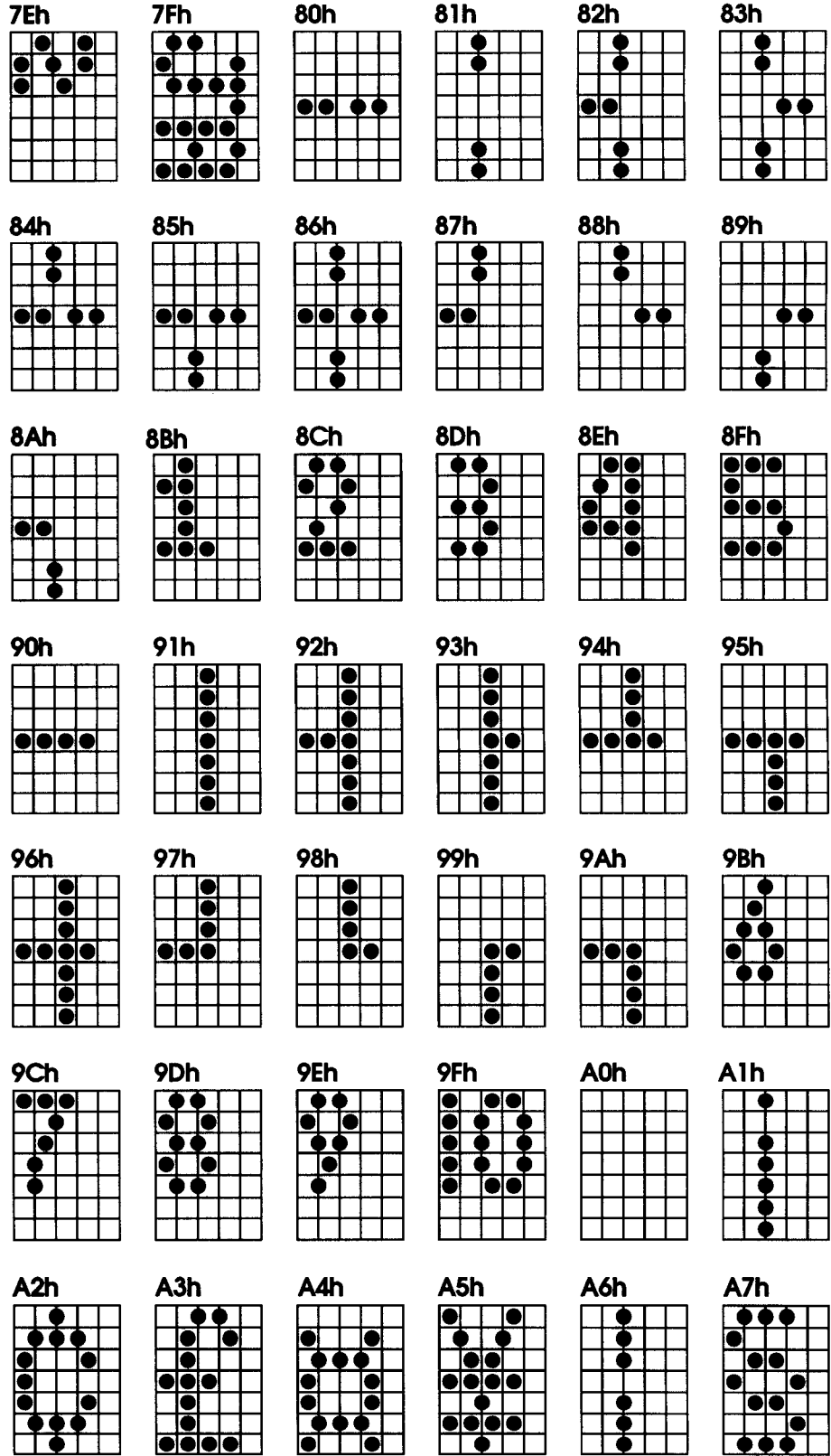

Appendix A: Standard Character Set

Font Image Codes
A8h to D1h

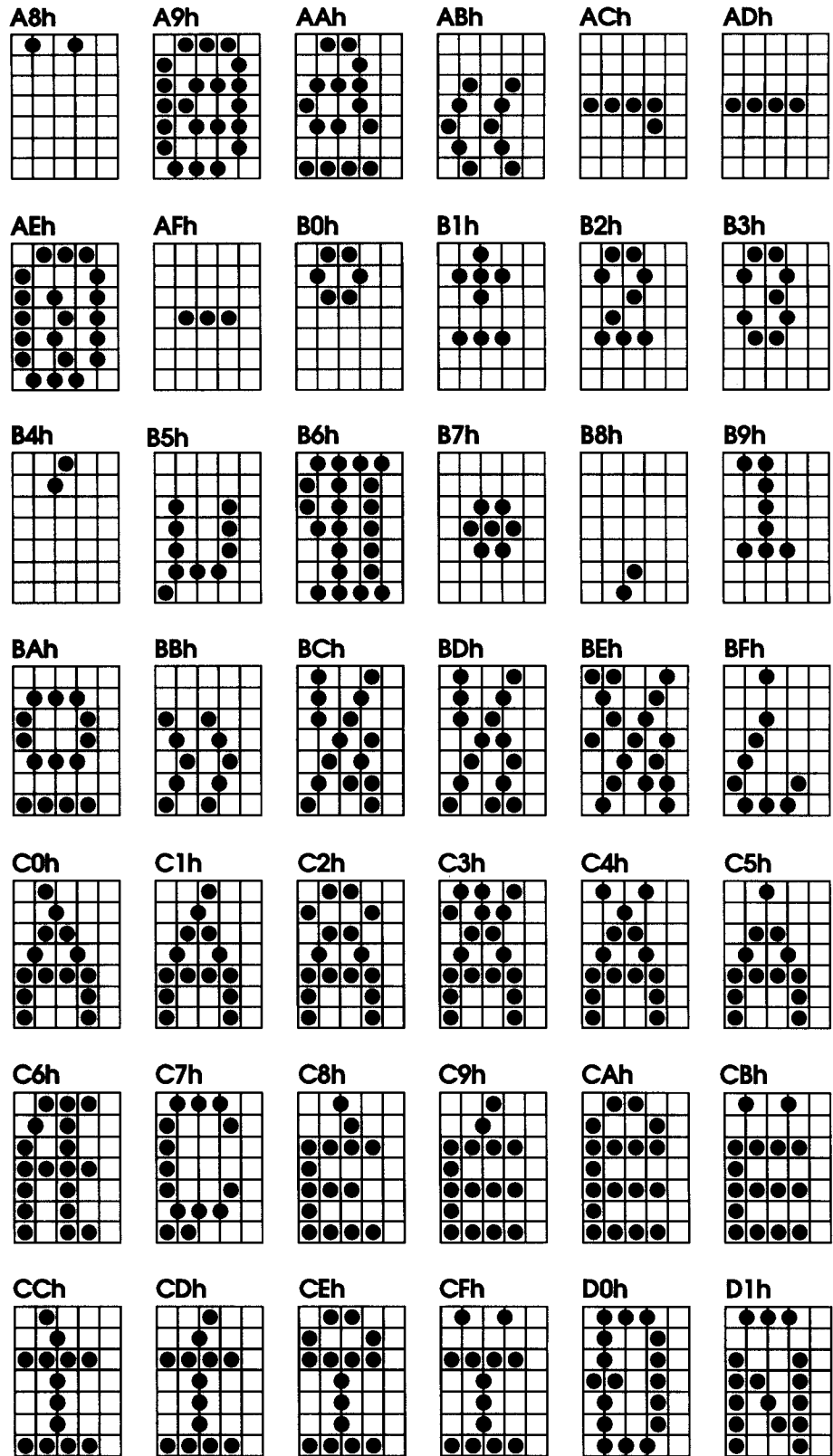

Printer 250 Reference and Programmer's Manual

Font Image Codes D2h to FBh

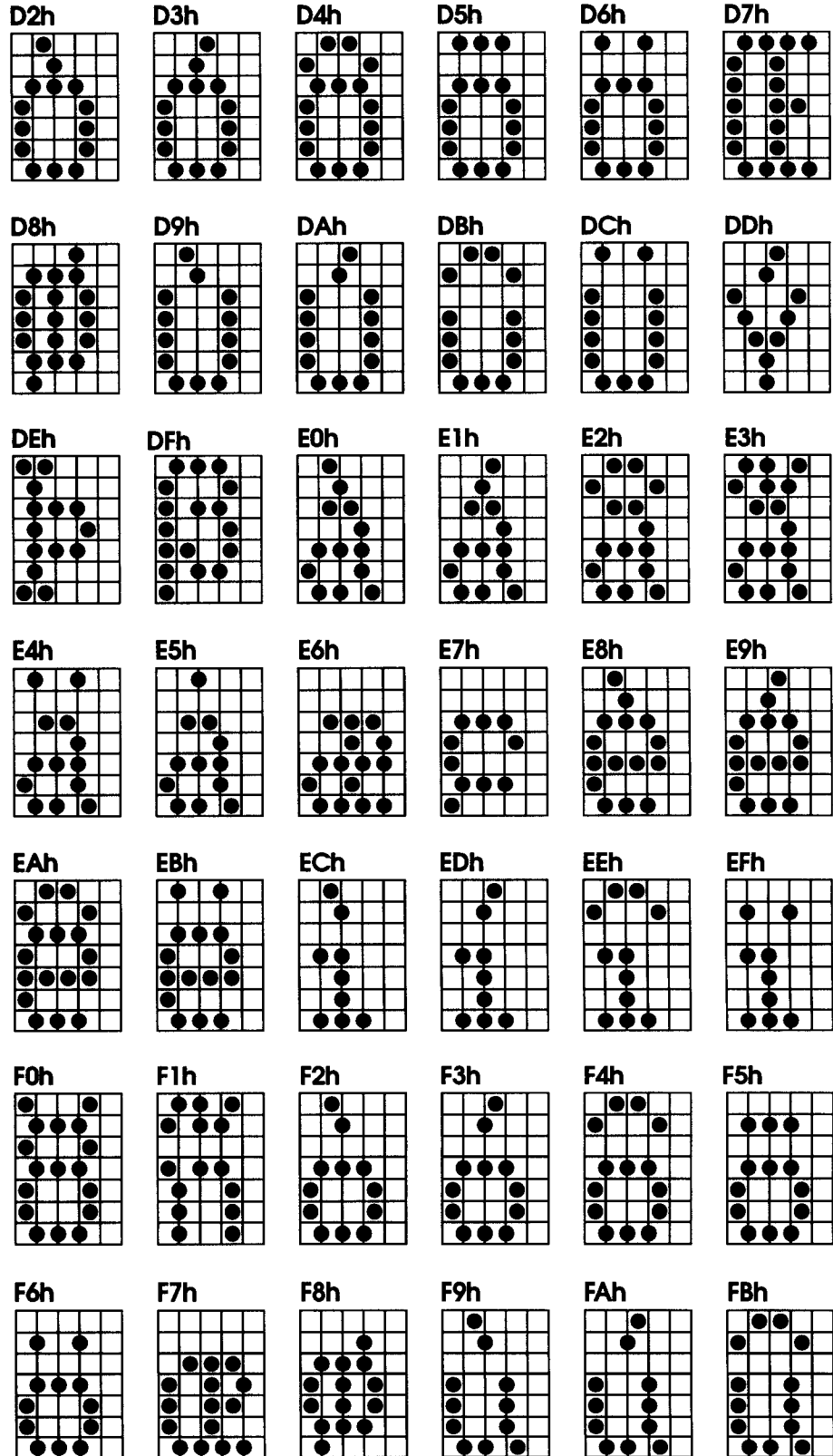

Appendix A: Standard Character Set

Font Image Codes
FCh to FFh

FCh

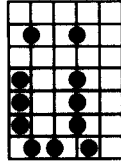

FDh

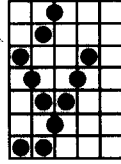

FEh

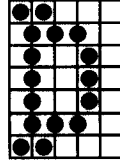

FFh

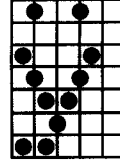

Appendix B: Slavic Character Set

The Slavic Character Set is only available on the Printer 250 Slavic model.

The first 160 characters (00h to 9Fh) of the Slavic Character Set are the same as the Standard Character Set (see Appendix A). The next 71 characters (A0h to E6h) are different and constitute the Slavic characters.

Font Images

The following pages show the actual font images and their associated codes in true aspect. Each font is printed in a character cell 5 dots wide and 7 dots tall. Full dot positions correspond to spaces between grid lines and half dot positions are those which sit upon the grid lines.

Printer 250 Reference and Programmer's Manual

Font Image Codes A0h to C9h

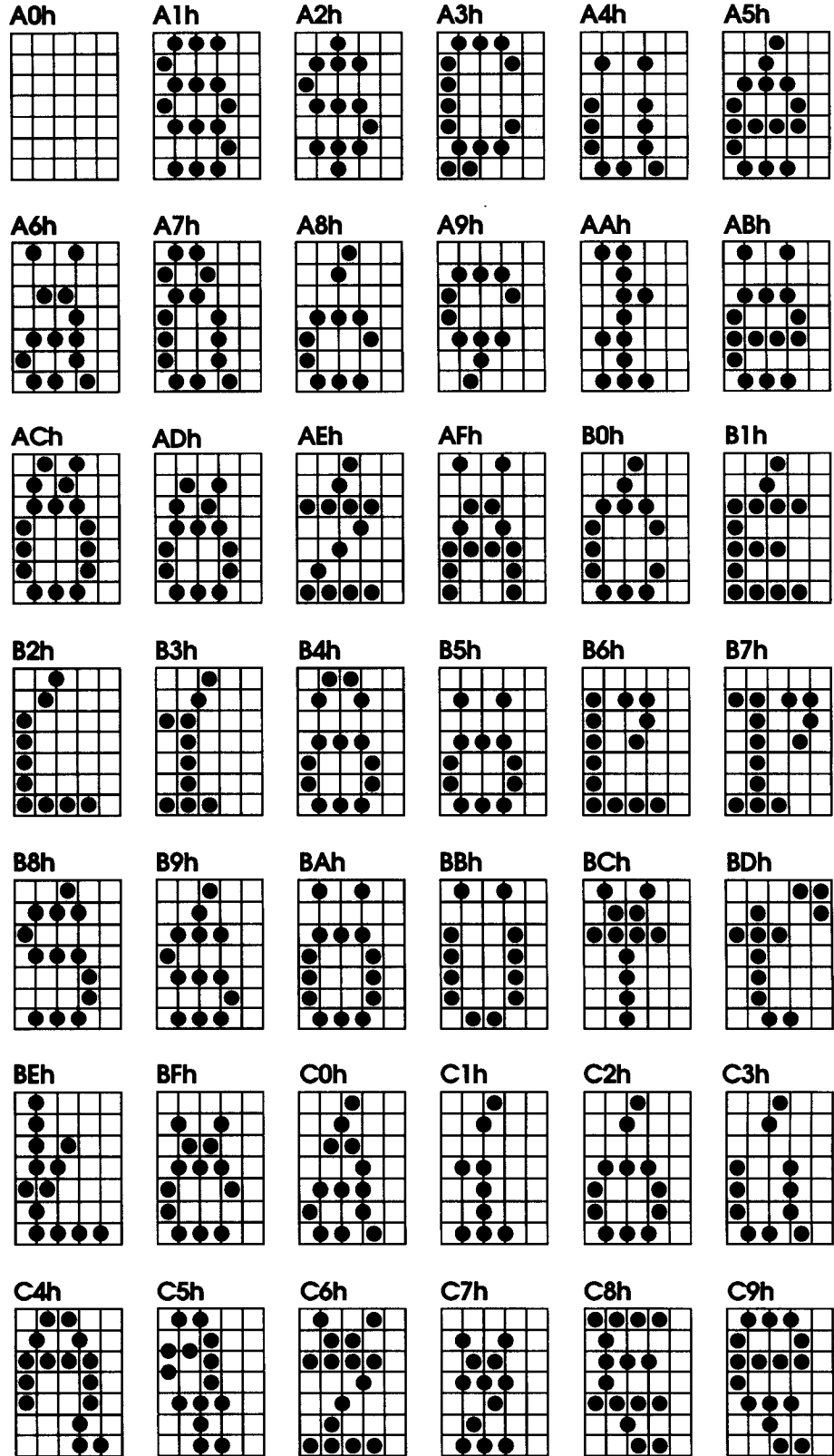

Appendix B: Slavic Character Set

Font Image Codes
CAh to E10h

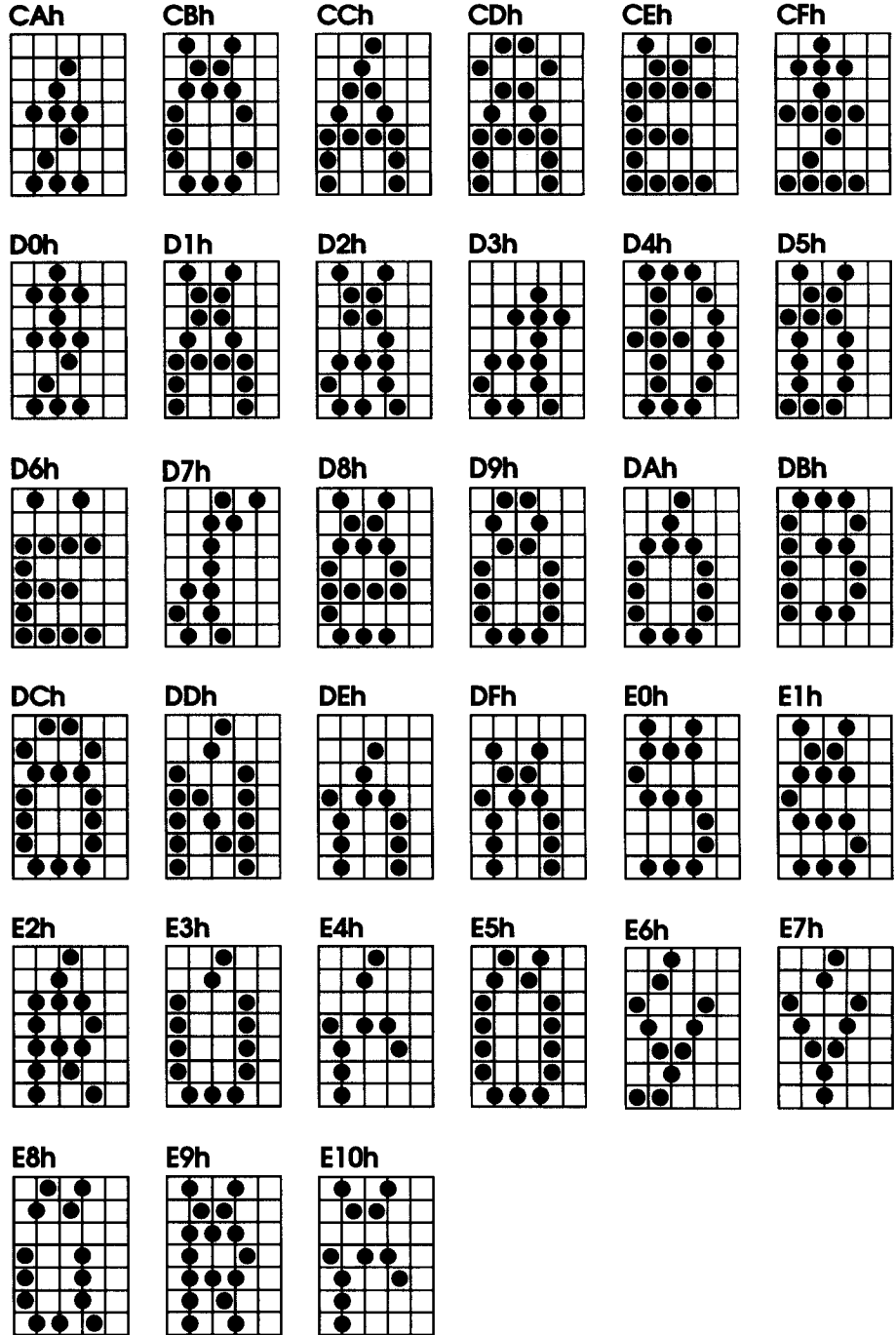

Printer 250 Reference and Programmer's Manual

Appendix C: Cyrillic Character Set

The Cyrillic Character Set is only available on the Printer 250 Cyrillic model.

Issuing the ETX command accesses the Cyrillic characters, located in the high-page graphics range A0h-BFh. See Chapter 3 for more information on the ETX command.

Font Images

The following page shows the actual font images and their associated codes in true aspect. Each font is printed in a character cell 5 dots wide and 7 dots tall. Full dot positions correspond to spaces between grid lines and half dot positions are those which sit upon the grid lines.

Printer 250 Reference and Programmer's Manual

Font Image Codes A0h to BFh

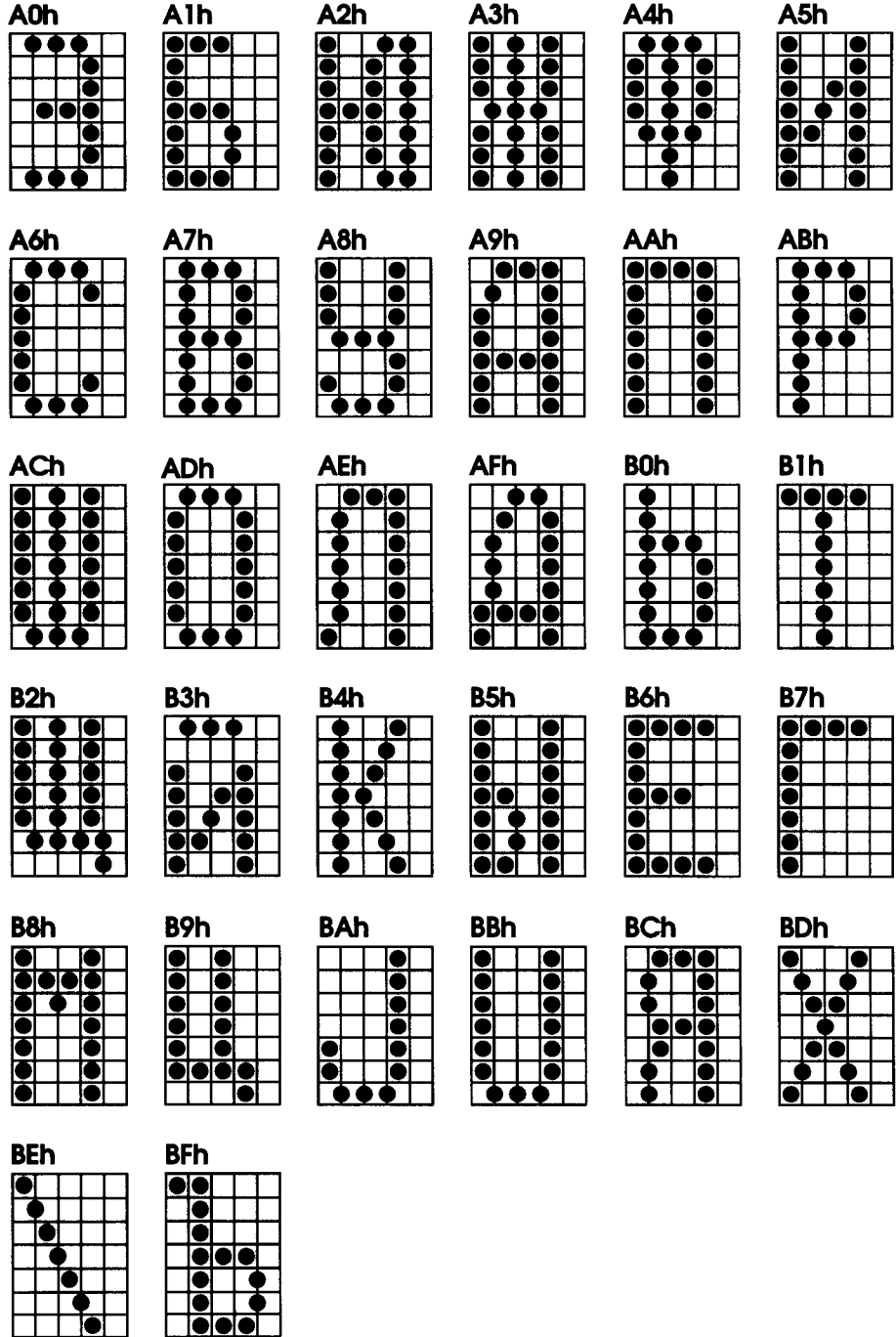

Index

A

Activate dot graphics
 mode (ESC g)..... 3 - 9
Adapter plug..... 1 - 1
ASCII character set..... 2 - 2
ASCII character set, select (SI) 3 - 6
Asynchronous interface..... 4 - 2
Attribute, line, select (ESC f).... 3 - 7

B

Baud rate setting..... 1 - 3
Black ribbon color..... 3 - 2
Buffer contents, print (LF) 3 - 2

C

Cables 1 - 1, 1 - 4
CAN - empty print buffer and
 cancel attribute 3 - 3
Cancel character attributes
 (CAN)..... 3 - 3
Cartridge, ribbon, replacement. 1 - 5
Case dimensions..... 4 - 2
Change ribbon color (DC2) 3 - 3
Changing the paper roll..... 1 - 6
Character attributes, cancel
 (CAN)..... 3 - 3
Character codes..... A - 1
Character download 3 - 8
Character set..... 2 - 3
 Denmark I (ESC h 4)..... 3 - 11
 Denmark II (ESC h 10).... 3 - 11
 France (ESC h 1)..... 3 - 11
 Germany (ESC h 2)..... 3 - 11
 Italy (ESC h 6)..... 3 - 11
 Japan (ESC h 8)..... 3 - 11
 Norway (ESC h 9)..... 3 - 11
 Spain (ESC h 7)..... 3 - 11
 Sweden (ESC h 5)..... 3 - 11
 United Kingdom (ESC h 3).. 3 - 11
 United States (ESC h 0).. 3 - 11
Character set (country), select
 (ESC h)..... 3 - 11

Character set

 Cyrillic..... C - 1
 Slavic..... B - 1
 specification..... 4 - 1
 standard..... A - 1

Character, pad (NUL) 3 - 5

Characters

 double height, by line
 (ESC f)..... 3 - 7
 double-width (RS or SO).... 3 - 5
 normal, by line (ESC f)..... 3 - 7
 printable..... 2 - 2

Check, periodic 1 - 7

Cleaning..... 1 - 7

Color, ribbon, change (DC2).... 3 - 3

Column spacing specification ... 4 - 1

Command set..... 2 - 2

Commands..... 3 - 1

Components..... 1 - 2

Control panel..... 2 - 1

Country code map 2 - 3

Country-dependent codes..... A - 2

Cyrillic font, select (ETX) 3 - 11

D

Data bits, setting..... 1 - 3

DC2 - change ribbon color 3 - 2

DEL code 2 - 2

Denmark I character set

 (ESC h 4) 3 - 11

Denmark I character

 substitutes A - 2

Denmark II character set

 (ESC h 10) 3 - 11

Denmark II character

 substitutes A - 2

DIP switches, setting 1 - 2

Dot graphics mode..... 2 - 2

Dot graphics mode, activate

 (ESC g) 3 - 9

Index

- Double-height characters, by
 - line (ESC f) 3 - 7
- Double-width mode (RS or SO) 3 - 5
- Download character 3 - 8
- Driver, typeface A - 1
- E**
- Eject paper (FF) 3 - 2
- Eject paper "n" lines (ESC b)... 3 - 4
- Electrical specifications 4 - 2
- Emulation mode, Printer 200 ... 2 - 2
- Environmental specifications 4 - 2
- Error detection and recovery 2 - 3
- ESC a - set line height to
 - "n" dots 3 - 3
- ESC b - eject paper n lines..... 3 - 3
- ESC c - reset printer to
 - power-up state 3 - 4
- ESC d - request printer status . 3 - 4
- ESC e - set right margin 3 - 6
- ESC f - select line attribute 3 - 6
- ESC g - activate dot graphics
 - mode 3 - 7
- ESC h - select character set
 - (country) 3 - 8
- ESC i - printer identification 3 - 7
- ESC l - download character 3 - 8
- ESC r - retrieve printer info 3 - 7
- F**
- Features 1 - 1
- Feed button 2 - 1
- FF - eject paper 3 - 2
- Files to support typeface A - 1
- Flashing power light 2 - 3
- Font data organization 2 - 3
- Font images A - 2
- Fonts A - 1
- France character set (ESC h 1) . 3 - 11
- France character substitutes A - 2
- FS - enter native mode 3 - 4
- G**
- Germany character set
 - (ESC h 2) 3 - 11
- Germany character substitutes.A - 2
- Graphic images 3 - 7
- Graphic line terminators 3 - 10
- Graphics, high-page (SO) 3 - 5
- GS - enter Printer 200
 - emulation mode 3 - 4
- H**
- Handshaking, interface 4 - 2
- Height, line, set (ESC a) 3 - 3
- High-page graphics (SO) 3 - 5
- I**
- Identification, printer (ESC i) 3 - 7
- Inking specifications 4 - 2
- Installation 1 - 4
- Italy character set (ESC h 6) ... 3 - 11
- Italy character substitutes A - 2
- J**
- Japan character set (ESC h 8) ... 3 - 11
- Japan character substitutes A - 2
- L**
- LF - print buffer contents 3 - 2
- Light, power, flashing 2 - 3
- Line attribute, select (ESC f) 3 - 7
- Line height, set (ESC a) 3 - 3
- Line spacing specification 4 - 1
- Line terminators, graphics 3 - 10
- Location for printer 1 - 1
- M**
- Maintenance 1 - 7
- Margin, right, set (ESC e) 3 - 6
- Mode
 - dot graphics 2 - 2
 - dot graphics, enter (ESC g) . 3 - 9
 - native 2 - 2

Index

- Mode, cont
 - native, enter (FS) 3 - 4
 - normal width (US or SI) 3 - 6
 - Printer 200 emulation 2 - 2
 - Printer 200 emulation,
 - enter (GS) 3 - 5
- N**
 - Native mode 2 - 2, 3 - 2
 - Native mode, enter (FS) 3 - 4
 - Normal characters, by line
 - (ESC f) 3 - 7
 - Normal-width mode (US or SI) 3 - 6
 - Norway character set
 - (ESC h 9) 3 - 11
 - Norway character substitutes ... A - 2
 - NUL - pad character 3 - 5
- P**
 - Pad character (NUL) 3 - 5
 - Paper
 - eject (FF) 3 - 2
 - eject "n" lines (ESC b) 3 - 4
 - low light 2 - 1
 - roll installation 1 - 6
 - roll removal 1 - 7
 - specifications 4 - 1
 - Parity setting 1 - 3
 - Pinouts, serial interface 4 - 3
 - Power
 - connection 1 - 4
 - light 2 - 1
 - light flashing 2 - 3
 - supply 4 - 2
 - supply unit specifications ... 4 - 2
 - switch 2 - 1
 - Power-up state, reset to
 - (ESC c) 3 - 4
 - Print buffer 2 - 2
 - contents (LF) 3 - 2
 - empty (CAN) 3 - 3
 - Print test 1 - 7
 - Printable characters 2 - 2
 - Printable images 3 - 10
 - Printer 200 emulation
 - mode 2 - 2, 3 - 2
 - Printer 200 emulation mode,
 - enter (GS) 3 - 5
 - Printer identification (ESC i) 3 - 7
 - Printer info, retrieve (ESC r) 3 - 7
 - Printer specifications 4 - 1
 - Printer status, request (ESC d) 3 - 4
- R**
 - Red ribbon color 3 - 2
 - Replacing the ribbon cartridge.. 1 - 5
 - Request printer status (ESC d) 3 - 4
 - Reset printer to power-up state 3 - 4
 - Ribbon cartridge inking
 - specifications 4 - 2
 - Ribbon cartridge replacement... 1 - 5
 - Ribbon color change (DC2) 3 - 3
 - Right margin, set (ESC e) 3 - 6
 - Roll of paper installation 1 - 6
 - RS - double width or
 - high-page graphics 3 - 5
 - RS-232C interface 4 - 2
 - RS-232C pinouts 4 - 3
- S**
 - Select character set 3 - 11
 - Select line attribute (ESC f) 3 - 7
 - Serial interface pinouts 4 - 3
 - Serial interface specifications ... 4 - 2
 - SI - normal width or select
 - ASCII characters 3 - 6
 - Signal level, interface 4 - 2
 - Slavic character set B - 1
 - SO - double width or
 - high-page graphics 3 - 5
 - Space character 2 - 2
 - Space code A - 1
 - Spain character set (ESC h 7) ... 3 - 11
 - Spain character substitutes A - 2
 - Specifications 4 - 1, 4 - 3
 - Standard character set A - 1

Index

Status, printer, request (ESC d). 3 - 4
Stop bits, interface 4 - 2
Sweden character set
 (ESC h 5)..... 3 - 11
Sweden character substitutes.. A - 2

T

Temperature, operating..... 4 - 2
Temperature, storage..... 4 - 2
Terminal connection 1 - 4
Terminators, graphic line..... 3 - 10
Typeface support files A - 1

U

United Kingdom character set
 (ESC h 3)..... 3 - 11
United Kingdom character
 substitutes..... A - 2
United States character set
 (ESC h 0)..... 3 - 11
United States character
 substitutes A - 2
Unpacking..... 1 - 2
US - normal width mode 3 - 6

W

Weight specification 4 - 2
Word length setting 1 - 3