

 **DONNER**

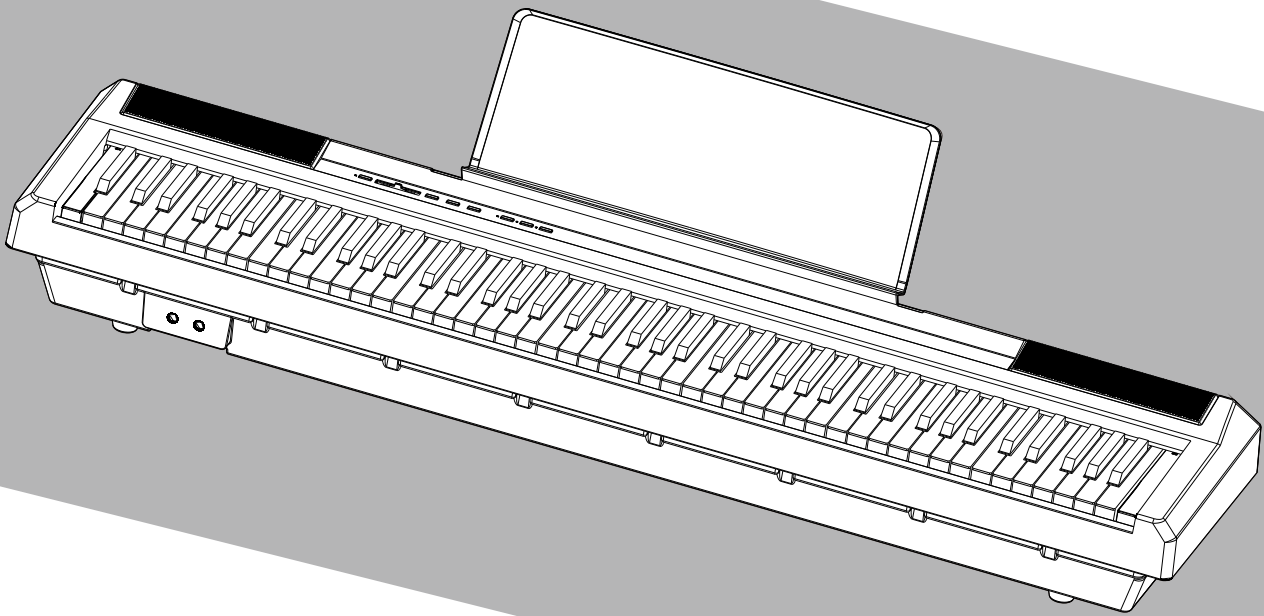

DEP-10

数码钢琴使用说明书

DIGITAL PIANO

INSTRUCTION MANUAL

Function & Specifications

Thank you for purchasing this digital piano. We will be committed ourselves to providing better service for you.

- ▲ Please read this instruction carefully before playing this piano.
- ▲ Please keep it in an appropriate way for future reference.

88 Half Weighted Hammer Keys

88 Half Weighted Hammer Keys give you the real touch of playing the piano.



Multi-Media MP3 Player

With MP3 player function, it could play the full role of music entertainment.

Earphone Socket

Exterior with double-earphone socket are convenient for playing without affecting others.

Operation

1. Piano Connection Interface Panel

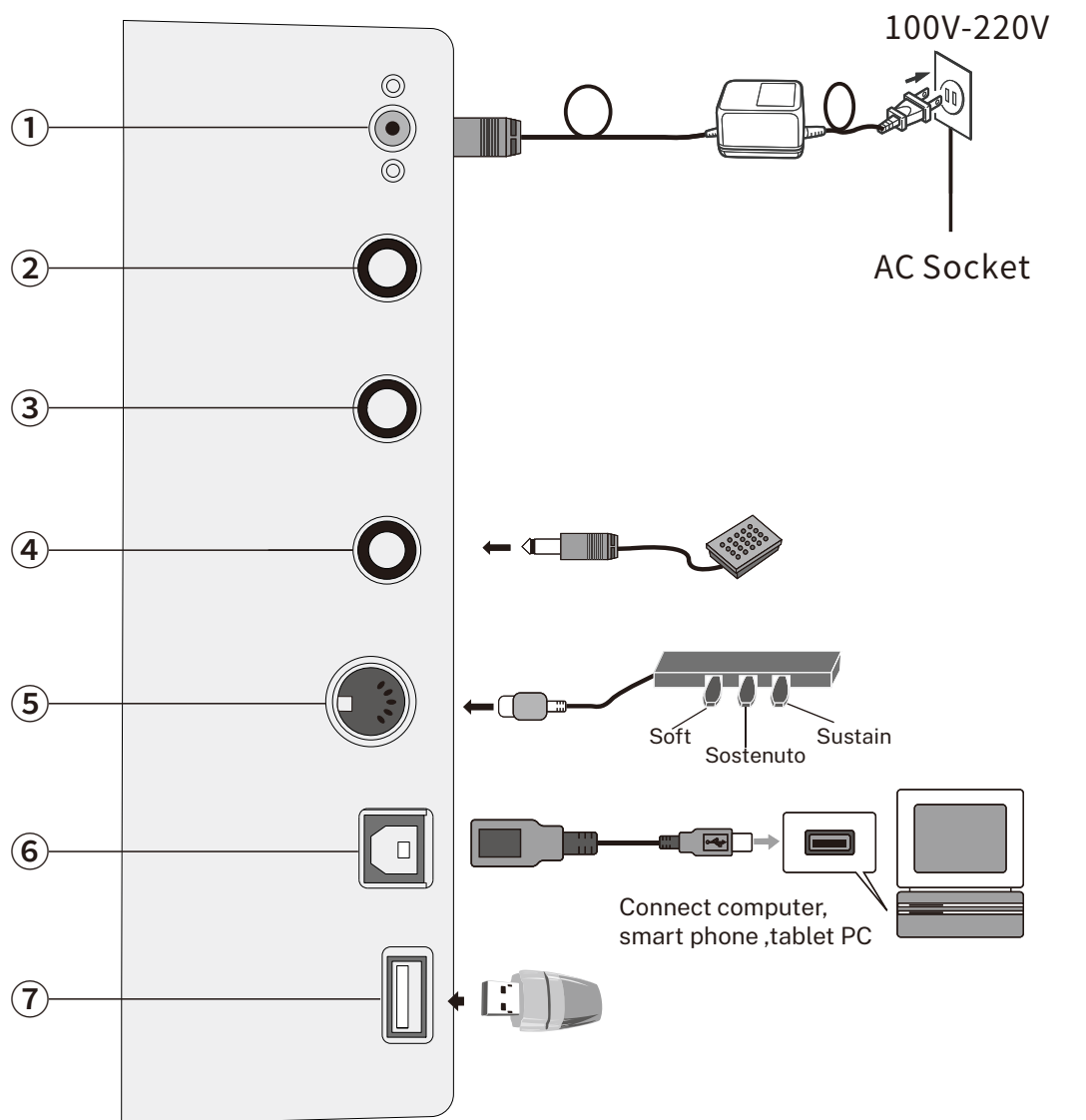

- ① Power Line Socket
- ② Audio Output
- ③ Audio Input
- ④ Sustain Pedal Socket
- ⑤ Pedals Socket
- ⑥ USB Transmission Socket
- ⑦ MP3 Socket

2. Earphone Interface

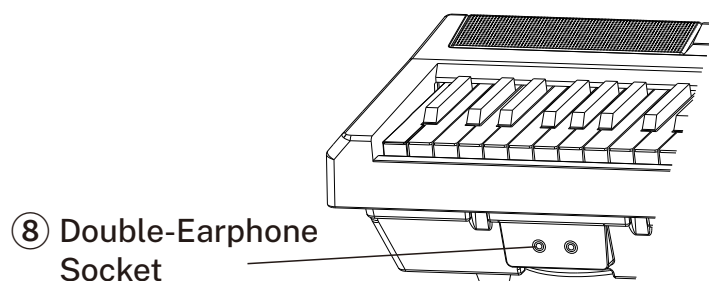

Operation

1. Power Line Socket

1. As figure shows, connect the power line when using. One end is inserted into the power outlet on the controller plate at the bottom of piano. The other end is inserted into a 100V-220V household socket.
2. Please unplug the power line and reserve it in an appropriate way when it is not used for a long time.

2. Audio Output

It supports external large speaker equipment by audio output plug.

3. Audio Input

External sound source can be connected to electric piano to play by audio input plug.

4. Sustain Pedal Socket

The product has tenuto pedal function. Please use pedal according to your needs when playing.

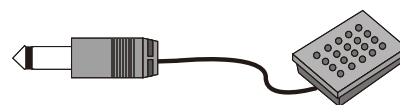

5. Pedals Socket

Insert the pedal plug into the round jack at the back of the piano and put through the triple pedals function with speaker effect. The order is as follows: Soft, Sostenuto, Sustain; Single pedal is optional. (Third Point)

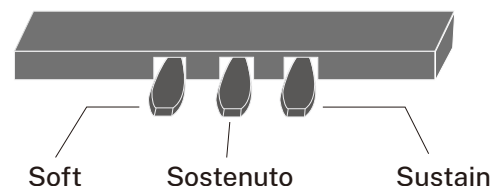

6. USB Transmission Socket

The product can be connected with computer by USB transfer interface. You can learn or play the keyboard to play, compose, store and operate other functions by the pre-installed music software on the computer. Edited music or accompaniments built in the music software can be played by the digital piano which is connected to the software or performed along with accompaniments.

7. MP3 Socket

1. Insert the flash disk with MP3 format songs into "USB plug" and play MP3 songs in 3 seconds or so.
2. By pressing the MP3 Control "▶||" button, MP3 songs can be paused or replayed.
3. Press once the control button of MP3 Control "◀◀" or "▶▶" lightly to select previous or next MP3 songs.
4. Adjust the volume of songs by long pressing the MP3 Volume "⊕" or "⊖" control button.

- The peak value of sound needs the control of main volume lever.

Attention!

- Only support songs with MP3 format.

8. Double-Earphone Socket

The connection of headphones will cut off the output of the piano built-in speaker for not disturbing others when performing. This product is designed with 2 earphone sockets which you can insert double earphones.

Installation

1. Slightly install the music stand into the groove of the piano body.

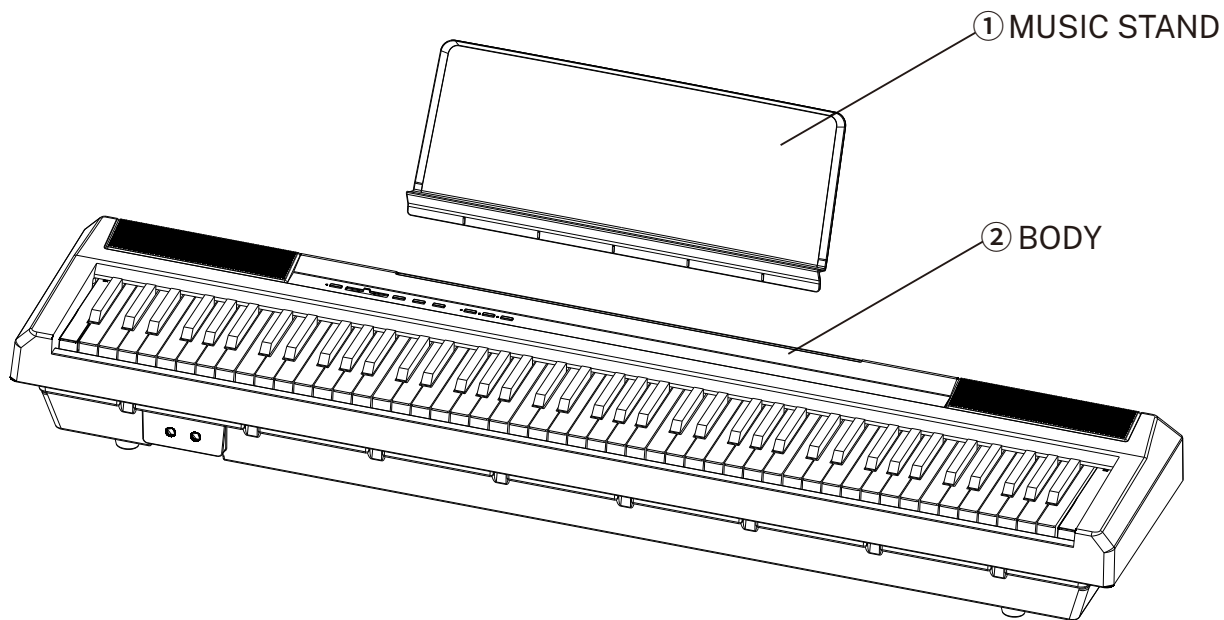

2. Insert pedal into the pedal jacks on the back of the body.

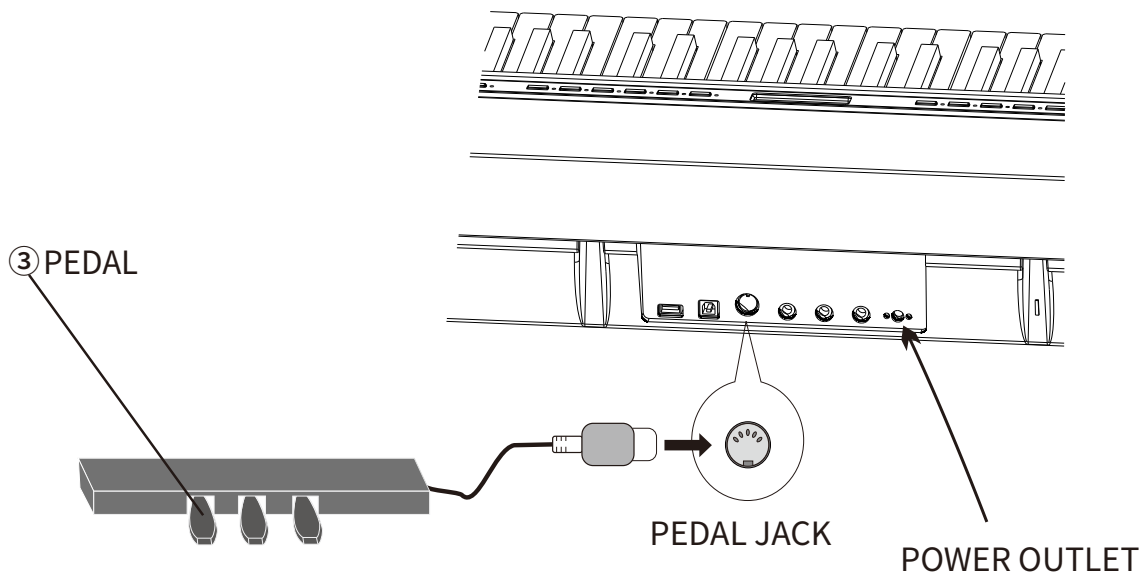

After the installation is done, plug in the power supply and start your music journey. (Power Outlet is on the back of the body.)

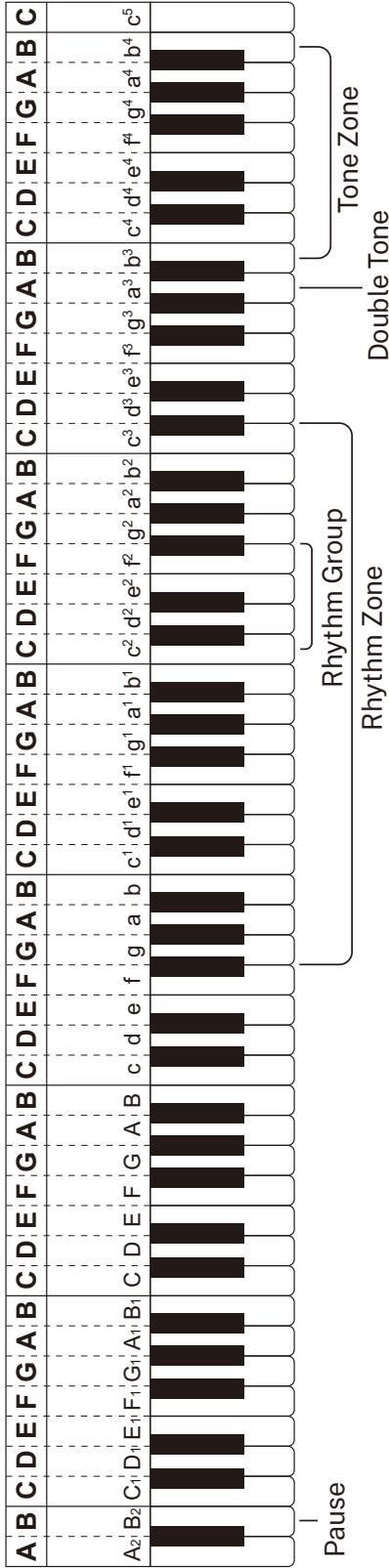
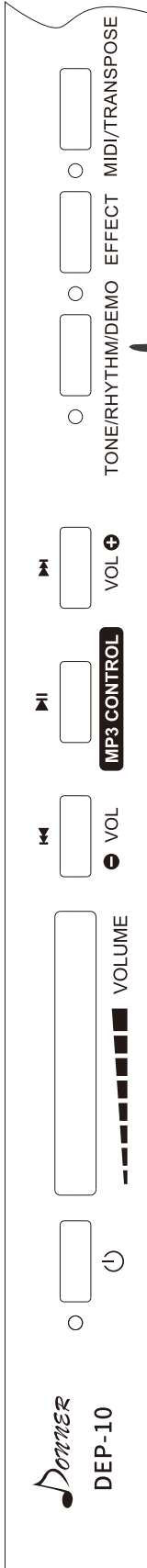

4. Tone Selection

1. Press the "Tone/Rhythm/Demo" button, and meanwhile press the one corresponding "white b3-b4" on the Tone Zone to play different instruments tones.
2. Press the "Tone/Rhythm/Demo" button, and meanwhile press the "white a3" to turn on/off Double Tone function.

- When you switch on the power supply, the default is "Acoustic Piano" tone.

5. Rhythm Selection

1. Press the "Tone/Rhythm/Demo" button, and meanwhile press the one corresponding "black & white keys" on the Rhythm Zone to play different rhythms.
2. Press the "Tone/Rhythm/Demo" button, and meanwhile press the "black & white keys" on the Rhythm Group to switch 4 groups of different rhythms.
3. Press "Rhythm" button, and meanwhile press "white A2" to pause.

Tone	Key	Rhythm	Key	Rhythm	Key	Rhythm	Key	Rhythm	Key	Rhythm	Key	Rhythm	Key				
Acoustic Grand Piano	c5	POP 1	#f	Rock 7	#a1	8 Beat 4	#f	16 Beat 10	#a1	Disco 4	#f	Samba 2	#a1	Country Shuffle2	#f	Ragtime 2	#a1
Bright Acoustic Piano	b4	POP 2	g	Rock 8	b1	8 Beat 5	g	Funk 1	b1	Disco 5	g	Samba 3	b1	Country Swing	g	Blues 1	b1
Electric Grand Piano	a4	POP 3	#g	Rock 9	c2	8 Beat 6	#g	Funk 2	c2	Rap	c2	Samba 4	c2	Country Two-Step	#g	Blues 2	c2
Chorus Piano	g4	POP 4	a	Rock 10	#c2	8 Beat 7	a	Funk 3	#c2	Techno 1	#c2	Samba 5	#c2	Jazz 1	a	Blues 3	#c2
Harpichord	f4	POP 5	#a	Slow Rock 1	d2	8 Beat 8	#a	Funk 4	d2	Techno 2	d2	Samba 6	d2	Jazz 2	#a	Blues 4	d2
Vibrating Harp	e4	POP 6	b	Slow Rock 2	#d2	8 Beat 9	b	Funk 5	#d2	Dance 1	#d2	Samba 7	#d2	Jazz 3	b	Big Band 1	#d2
Church Organ	d4	POP 7	c1	Slow Rock 3	e2	8 Beat 10	c1	Funk 6	e2	Dance 2	e2	Samba 8	e2	Jazz 4	c1	Big Band 2	e2
Strings Ensemble	c4	POP 8	#c1	Glam Metal 1	f2	16 Beat 1	#c1	Funk 7	f2	Dance 3	f2	Samba 9	#c1	Jazz 5	#c1	Big Band 3	f2
		POP 9	d1	Glam Metal 2	#f2	16 Beat 2	d1	Funk 8	#f2	Dance 4	d1	Samba 10	#f2	Jazz Ballad	d1	Dixieland 1	#f2
		POP 10	#d1	Glam Metal 3	g2	16 Beat 3	#d1	Funk 9	g2	Dance 5	#d1	Country 1	g2	Jazz Waltz	#d1	Dixieland 2	g2
		Rock 1	e1	Punk Rock 1	#g2	16 Beat 4	e1	Funk 10	#g2	Dance 6	e1	Country 2	#g2	Jazz Band	e1	Fusion	#g2
		Rock 2	f1	Punk Rock 2	a2	16 Beat 5	f1	70s Disco 1	a2	Dance 7	f1	Country 3	a2	Swing Jazz	f1	Hawaii	a2
		Rock 3	#f1	Punk Rock 3	#a2	16 Beat 6	#f1	70s Disco 2	#a2	Dance 8	#f1	Country 4	#a2	Cool Jazz	#f1	Guaracha	#a2
		Rock 4	g1	8 Beat 1	b2	16 Beat 7	g1	Disco 1	b2	Dance 9	g1	Country 5	b2	5/4 Beat 1	g1	Charleston	b2
		Rock 5	#g1	8 Beat 2	c3	16 Beat 8	#g1	Disco 2	c3	Dance 10	#g1	Country Ballad	c3	5/4 Beat 2	#g1	Macarena	c3
		Rock 6	a1	8 Beat 3	#c3	16 Beat 9	a1	Disco 3	#c3	Samba 1	a1	Country Shuffle	#c3	Ragtime 1	a1	Musette	#c3

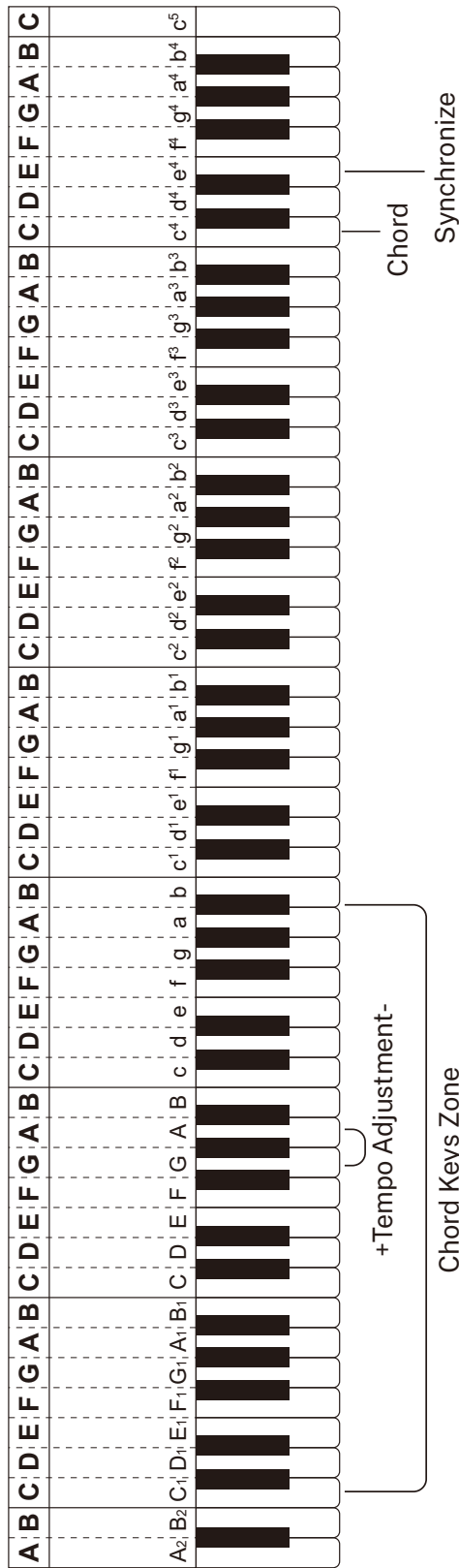
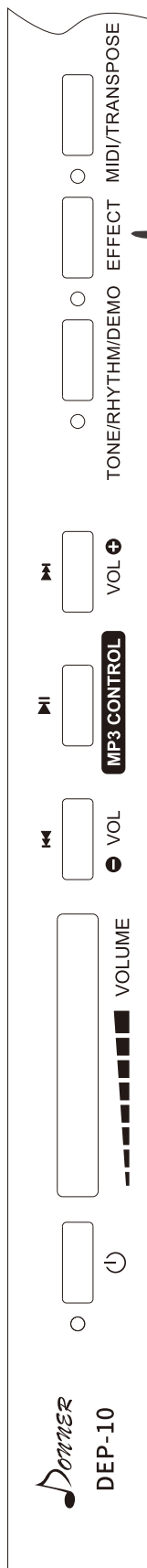

6. Tempo Adjustment

When playing rhythms, press "EFFECT" button and meanwhile press "white G/A" to adjust the tempo of rhythm.

7. Chords

1. When playing rhythms, press "EFFECT" button and meanwhile press "white c4", play rhythms and chords with one finger in the left chord keys zone (1-34 keys from left). Press "EFFECT" button and meanwhile press "white c4" to stop playing the rhythms or chords.
2. When playing rhythms, press "EFFECT" button and meanwhile press "white d4", play rhythms with multi-fingers in the left chord keys zone (1-34 keys from left).

8. Synchronized Startup

You can set this product so that when you play chord accompaniment on the keyboard, you can start playing rhythm at the same time.

1. In the state of chord, press "EFFECT" button, and meanwhile press "white e4", enter synchronous start standby state.
2. Play the chord (1-34 keys from left) and the accompaniment and chord will begin to play.
3. To cancel the synchronization state, press the "EFFECT" button, and meanwhile press the "white e4" button, you can stop.

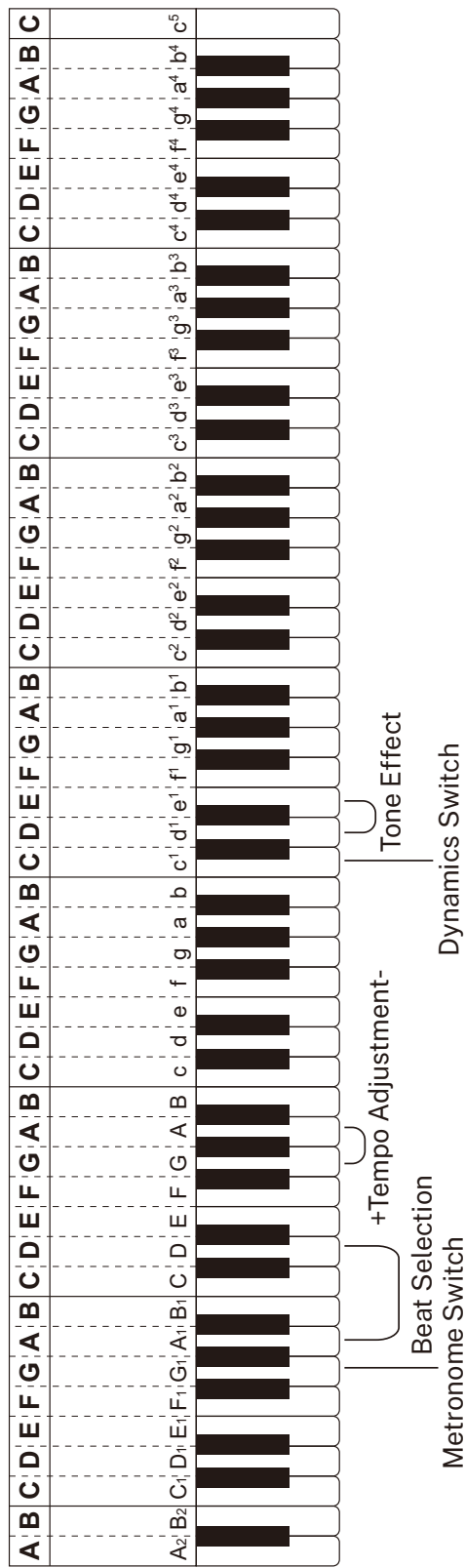
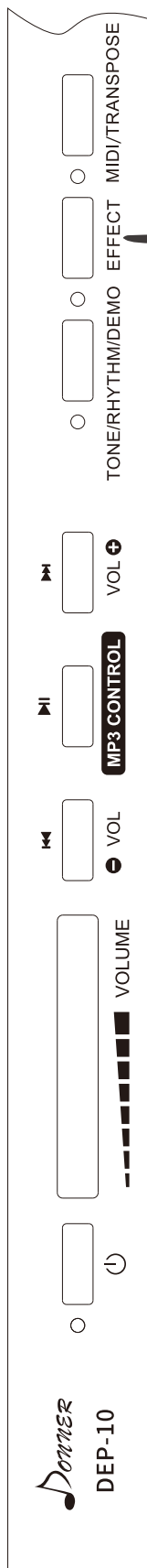

9. Dynamics Response Switch

Press the "EFFECT" button and press "white C1" meanwhile, to turn ON / OFF dynamics response.

- The default is "ON".

10. Metronome Switch

1. Press the "EFFECT" button and press "white G1" meanwhile to turn ON/ OFF the Metronome Switch.
2. Press the "EFFECT" button and press "white A1-D" meanwhile in the Beat Selection zone to choose the types of beat, 4 types at total.
3. Press the "EFFECT" button and press "white G-A" meanwhile in the Tempo Adjustment zone to adjust the tempo of metronome.

11. Effect Control

1. Press the "EFFECT" button and press "white d1" meanwhile in the Tone Effect zone to turn ON/OFF the Trill effect.
2. Press the "EFFECT" button and press "white e1" meanwhile in the Tone Effect zone to turn ON/OFF the Suspension effect.
3. Press the "EFFECT" button and press "black #d1" meanwhile in the Tone Effect zone to turn ON/OFF the DSP effect.

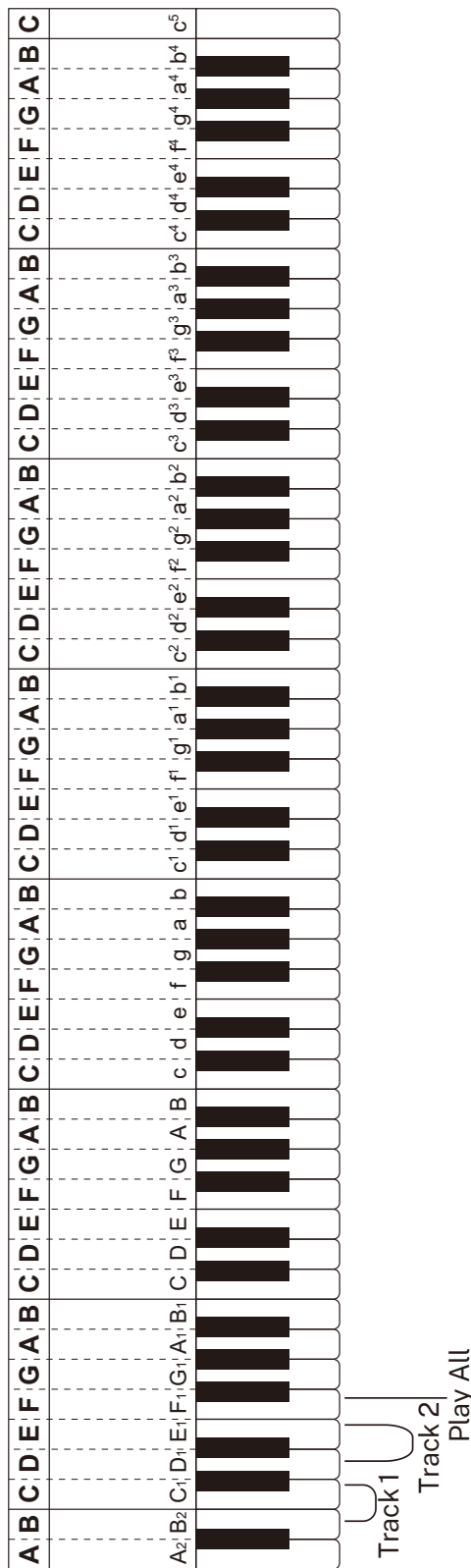
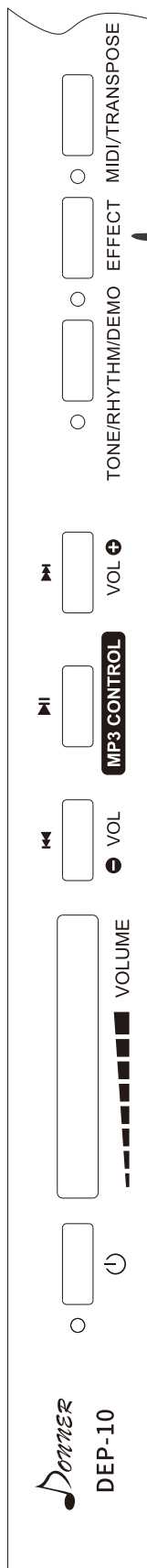

12. Recording

Recording function includes record and play the playing music. There are two tracks.

Track 1 Record & Play:

- 1. Press the "EFFECT" button and press "white B2" meanwhile on the Track 1, start to record the track 1.
- 2. When you play on the keyboards or step on the pedal, which starts to record the notes.
- 3. Press "EFFECT" again and press "white B2" on the Track 1 to stop the track 1 recording.
- 4. Press the "EFFECT" button and press "white C1" meanwhile on the Track 1, start to play the track 1 recorded notes.

Track 1 Record & Play:

- 1. Press the "EFFECT" button and press "white D1" meanwhile on the Track 2, start to record the track 2.
- 2. When you play on the keyboards or step on the pedal, which starts to record the notes.
- 3. Press "EFFECT" again and press "white D1" on the Track 2 to stop the track 2 recording.
- 4. Press the "EFFECT" button and press "white E1" meanwhile on the Track 2, start to play the track 2 recorded notes.

Track 1 & 2 Simultaneous Playing:

- Press "EFFECT" and "white F1" meanwhile, to play the recorded notes on the track 1 & 2 simultaneously.

Storage capacity is about 5000 characters. Storage content includes foot pedal operation and notes transformation. For example, when the amount of pedal operation increases, the number of keyboard symbols played decreases relatively.

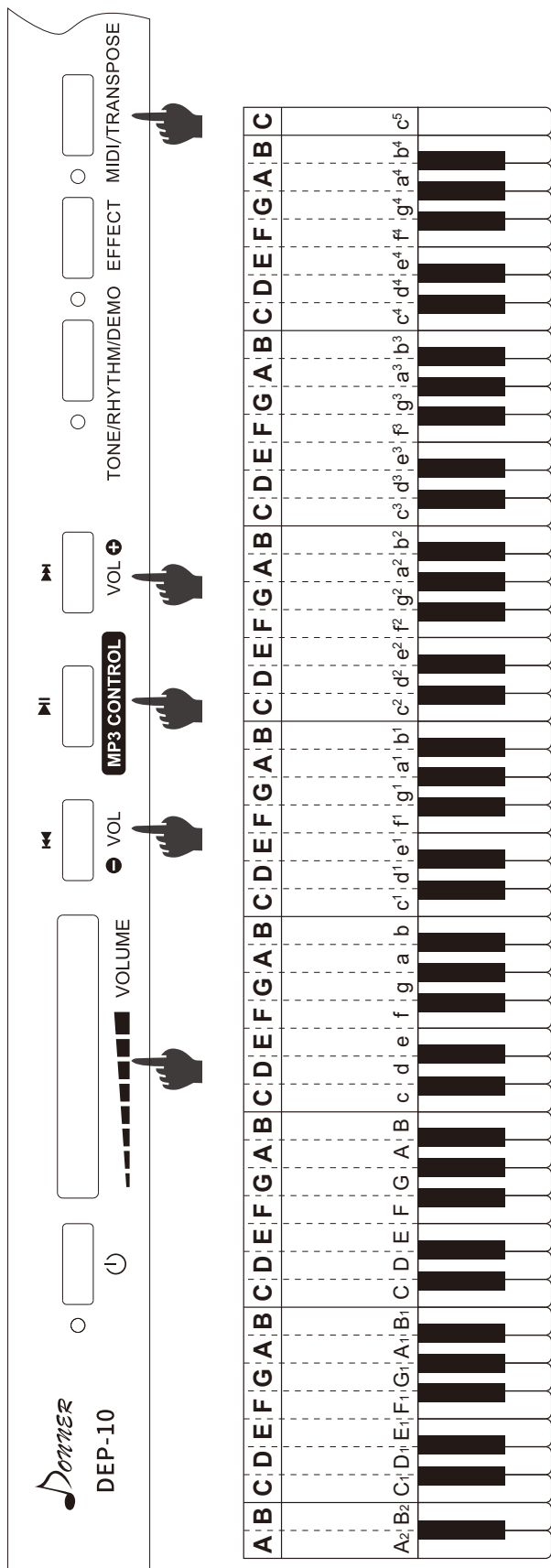

13. Transpose

The Transpose function can change the tone of the playing keyboard without changing the finger movement of the keyboard.

- 1. Press the "Transpose" button and meanwhile press the "white g3" to turn on and off the Transpose function.
- 2. Press the "Transpose" button and meanwhile press the "black & white f2-f3" in the Transpose zone to change the tone of the playing keyboard.

14. MP3 Player

1. Insert the flash disk with MP3 format songs into "USB plug" and play MP3 songs in 3 seconds or so.
2. By pressing the MP3 Control "▶|◀" button, MP3 songs can be paused or replayed.
3. Press once the control button of MP3 Control "◀◀" or "▶▶" lightly to select previous or next MP3 songs.
4. Adjust the volume of songs by long pressing the MP3 Volume "⊕" or "⊖" control button.

- The peak value of sound needs the control of main volume lever.

Attention!

- Only support songs with MP3 format.

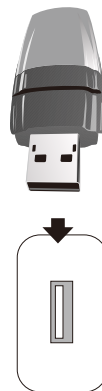

Accessories List

Name	Quantity
Power	1 PCS
Digital Paino	1 PCS
Music Stand	1 PCS
Instruction	1 PCS

Specifications

Keys: 88	Intonation: ≤ 3 cents
Range: A2~C5	Output Power: $\geq 25W \times 2$
Model: Portable Piano	Parameters: DC 12V 3A 50/60Hz

Conscientiously do a good job in the maintenance and protection of this product. It plays an important role in prolonging the service life and reducing faults.

1. Avoid heat, dampness, or direct sunlight.

The product should not be exposed excessively to the direct sunlight, placed near the air conditioner or extremely hot places.

2. No use near TV or radio.

This product may cause video or audio interference to the reception of TV and radio. If this happens, it should be removed from the radio or TV products.

3. Don't use paint, diluent or similar chemicals to clean it.

Wet a soft towel with weak solution and detergent and wring it out until it dries. Clean the product with this towel.

4. No shaking and collision.

The product should be moved carefully. Violent shake and collision are prohibited to avoid damaging the shell or internal electronic components.

Power Adapter

This product can be supplied by standard indoor wall socket. Please use only the power cord specified by this product. When you do not use, please be sure to turn off the power supply. If you do not use it for a long time, please pull out the power cord and keep it properly.

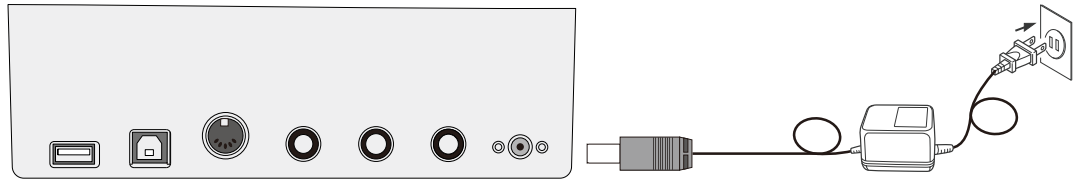

Sign

In order to ensure that you use this product safely and correctly, prevent damage to the user and other people and the financial issue. The specification and the product are marked with a series of safety signs. All kinds of signs and their meaning are as follows:

Warning

This sign indicates that, if you ignore the flag and error operation of this product, there is a fire hazard or serious injury to personnel.

Attention

This sign indicates that, if you ignore the flag and the wrong operation of this product, there is a potential risk of injury or other financial damage caused by personnel.

Logo example



This triangle mark indicates that the user should pay attention to the matters. (Left case shows “Be careful electric shock.”)



The circular sign painting a slash said prohibited matters. The logo shows the specific content of the ban. (Left case shows “No Disassemble”.)



Black dots indicate matters must be complied with. Icon in this sign indicates the specific content that must be followed. (Left case shows “The power plug must be pulled out of the socket.”)

Warning

Smoke, odor, overheating

When the product is smoking, emitting odors or overheating, continue use may lead to the danger of fire and electric shock. In the event of such a situation, the following operations shall be carried out immediately.

- Turn off the power supply.
- Pull the plug from the power outlet.
- Contact your agency.

Power line

Improper use of power supply leads to danger of fire and electric shock must observe the following precautions.

- Special power lines specified for this product must be used.
- An AC power source with output voltage within the household rated voltage must be used.
- It is not allowed to overload the power socket and the power extension line.

Improper handling of power lines may result in damage or rupture, which may cause the danger of fire and electric shock. The following precautions must be observed:

- Do not place heavy objects on the power line or make them heated.
- Do not attempt to transform the power cord or bend it too much.
- Do not twist or pull the power cord.
- If the power cord or plug is damaged, replace the power cord of the same type.

Do not use wet hands to touch the power cord and plug, otherwise there is a risk of electric shock.



- Please use the power lines in the place where the water will not be spilled. Water has the risk of fire and electric shock.
- Never put a vase or any other container with water on this product. Water has the risk of fire and electric shock.
- Do not let the minors contact plug and power line or a connecting plate. The minors have less knowledge of electricity safety which may cause danger of electric shock.



Warning

Improper use of power lines has the risk of fire and electric shock hazard. The following precautions must be observed.

- Do not place the power cord near the furnace or other heat sources.
- Unplug the power cord from the power outlet. The plug body must be grasped.
- Plug the power cord into the power socket.
- Before connecting or cutting off the power cord, make sure that the power is off.
- The power cord should be removed from the electrical outlet of the wall before a thunderstorm occurs or traveling or before other long leave.
- At least once a year, unplug the power cord from the wall outlet and clean the dust around the plug.



Don't burn this product

Do not put this product into the fire otherwise it will cause the burning of wood products and the explosion of the internal electronic components. There is a danger of fire and personnel injury.



Water and foreign matter

Water and other liquids and (metal) into this product has the risk of causing fire and electric shock. The following operation should be performed immediately when the above situation occurs.

1. Turn off the power supply.
2. If the power cord is used for power supply, it will be pulled off from the wall of the power outlet.
3. Contact your dealer.



Dismantling and rebuilding

Do not disassemble this product or transform it in any way. Otherwise it will be hazardous to electrical shock, burns or other personal injury. All internal inspection, adjustment and maintenance operations should be entrusted to your dealer.



Drop or impact

This product is subject to the risk of fire and electric shock after falling or being subjected to a strong impact. The operation should be performed immediately following the above mentioned situation.

1. Turn off the power supply.
2. If the power cord is used for power supply, it should be pulled off.
3. contact your dealer.



Plastic bag

Do not let any person put the plastic bag on the head or put in the mouth. Otherwise there is the risk of suffocation families with children should pay special attention to that.



Keep the distance with the product and support.

Climb the body or its support is in danger of tipping or damage. The children's families should pay special attention to.



Display

You should avoid placing this product on an uneven surface or any other unstable place. Otherwise, it will cause it falling and a risk of injury to the person.



Product movement

Before moving this product, you must first pull off the wall of the power outlet, the power cord plug and pull off all other cables and connecting wires. Otherwise there will be damage to the line, resulting in fire and electric shock hazard.



Clean

Before you clean this product, you must first remove the power cord from the wall outlet, otherwise there is a risk of fire and electric shock.



Interface

The interface of this product can only be connected to the specified equipment and devices. The connection of non designated equipment or devices have the risk of fire and electric shock.



Location selection

This product shouldn't be put in the following places. Otherwise there will be a risk of fire or electric shock.

- 1. High temperature or dusty places.
- 2. Kitchen or other places with oil fumes.
- 3. A place where direct sunlight is irradiated. Do not expose to excessive heat or moisture environment .



Volume

Do not play music at high volume for long periods of time. Special attention should be paid when using the headphones. Too high volume may damage your hearing.



Heavy objects

Do not place heavy objects on this product otherwise the top will be overloaded causing the product or the object falling and the risk of injuring persons.



Correct assembly of the support

The incorrect assembly of support will make it overturned, causing the product dropping and the risk of injuring personnel.

Therefore, it is necessary to carry out the instructions in accordance with the instructions to ensure that the product is properly installed.



Replace the fuse

If the fuse breaks, there may be short circuit or voltage instability in the product. Professionals are required to identify and replace them, otherwise there is a risk of fire or electric shock.



AFTER-SALES SERVICE

WARRANTY CARD

Warranty Provisions:

1. If failure occurs in the normal use of this product, from the date of purchase (invoice date) you can enjoy _____ day's free warranty service.
2. The failure occurs during the warranty period, the warranty card and the shopping note must be shown in maintenance time.
3. Free warranty will not be provided in the following cases:
 - A. The same warranty card and shopping notes cannot be provided at the same time.
 - B. The purchase date of the bill is altered.
 - C. The damage caused by improper use of user.
 - D. The fault caused by fire, flood, earthquake, lightning and other irresistible factors.
 - E. The failure caused by unauthorized removal.
4. After the expiration of guarantee period, our company is responsible for the maintenance but charge a fee as appropriate.

Maintenance Point: _____

Contact Number: _____



Donner Technology Co., Ltd.
www.donnerdeal.com
www.idonner.com



品 牌: *Donner* 唐农
生产商: 广州蓝深科技有限公司
网 址: www.donner.com.cn