

Sheet: switch\_matrix

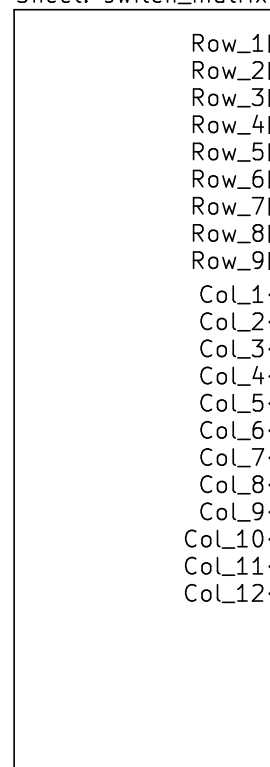

File: switch\_matrix.sch

Sheet: mcu

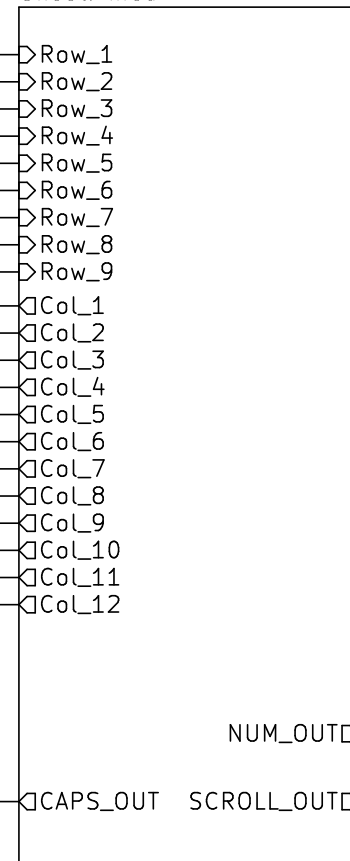

File: mcu.sch

Sheet: leds

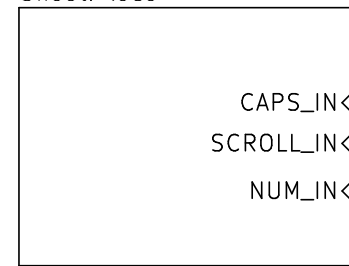

File: leds.sch



LOGO

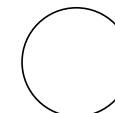

LOGO1

Stab

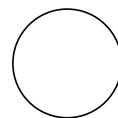

T5015-2

Stab

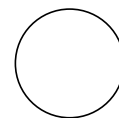

T3013

Stab

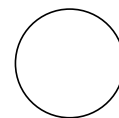

T401

Stab

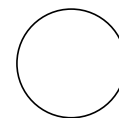

T4012-2

Stab

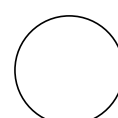

T506

Stab

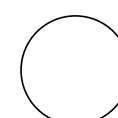

T5019-2

Stab

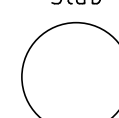

T5022-2

Stab

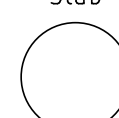

T3022-2

Stab

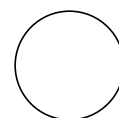

T506-2

Sheet: /  
File: cain.sch

**Title:**

Size: A4

Date:

KiCad E.D.A. kicad (5.1.12)-1

**Rev:**

Id: 1/4

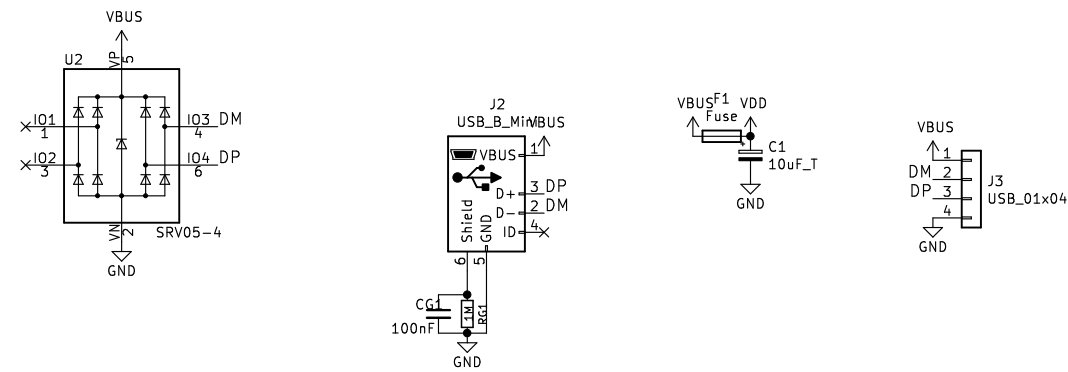
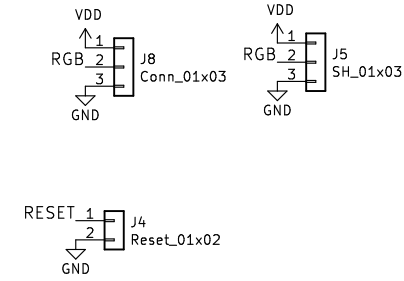
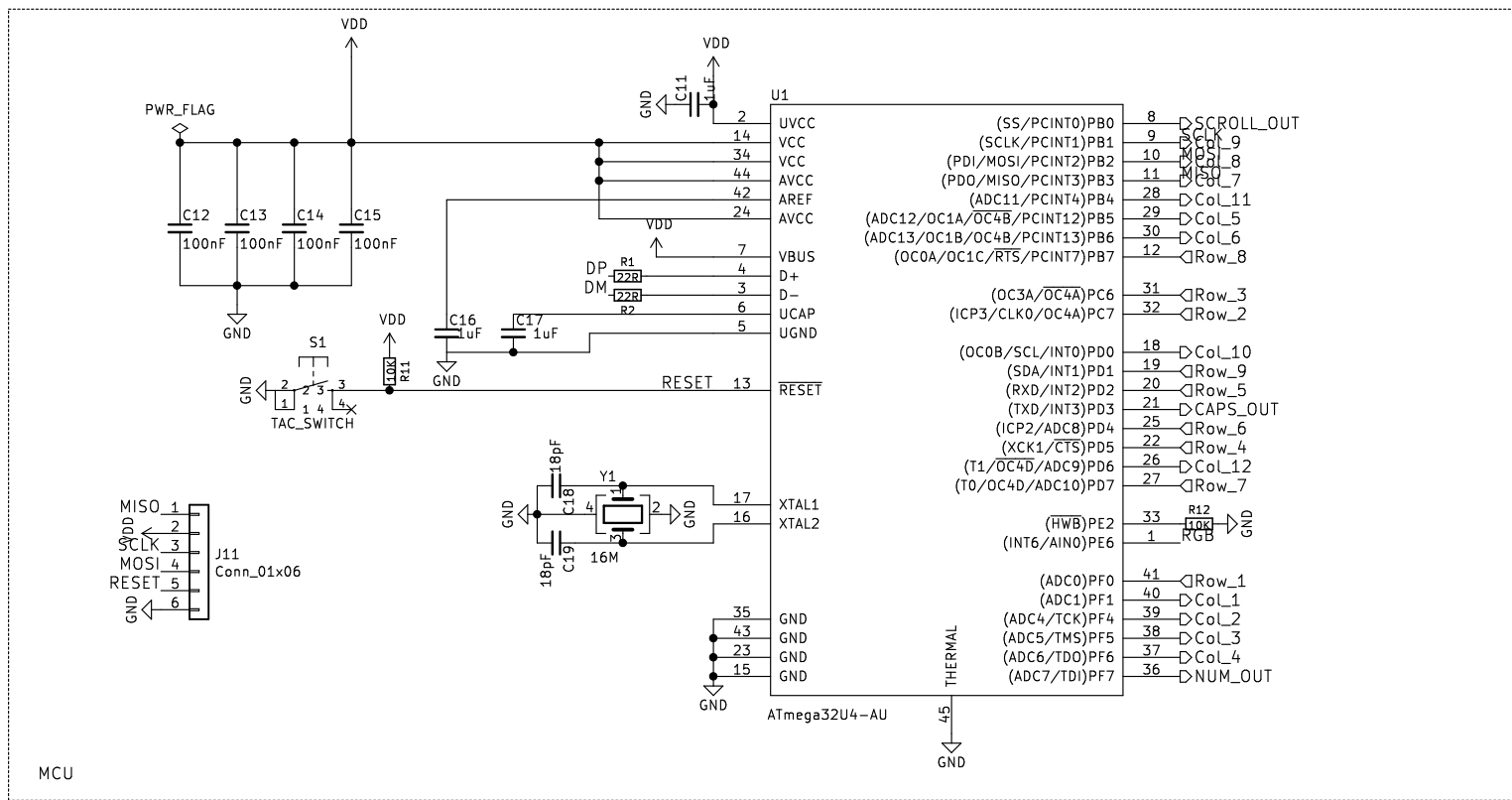

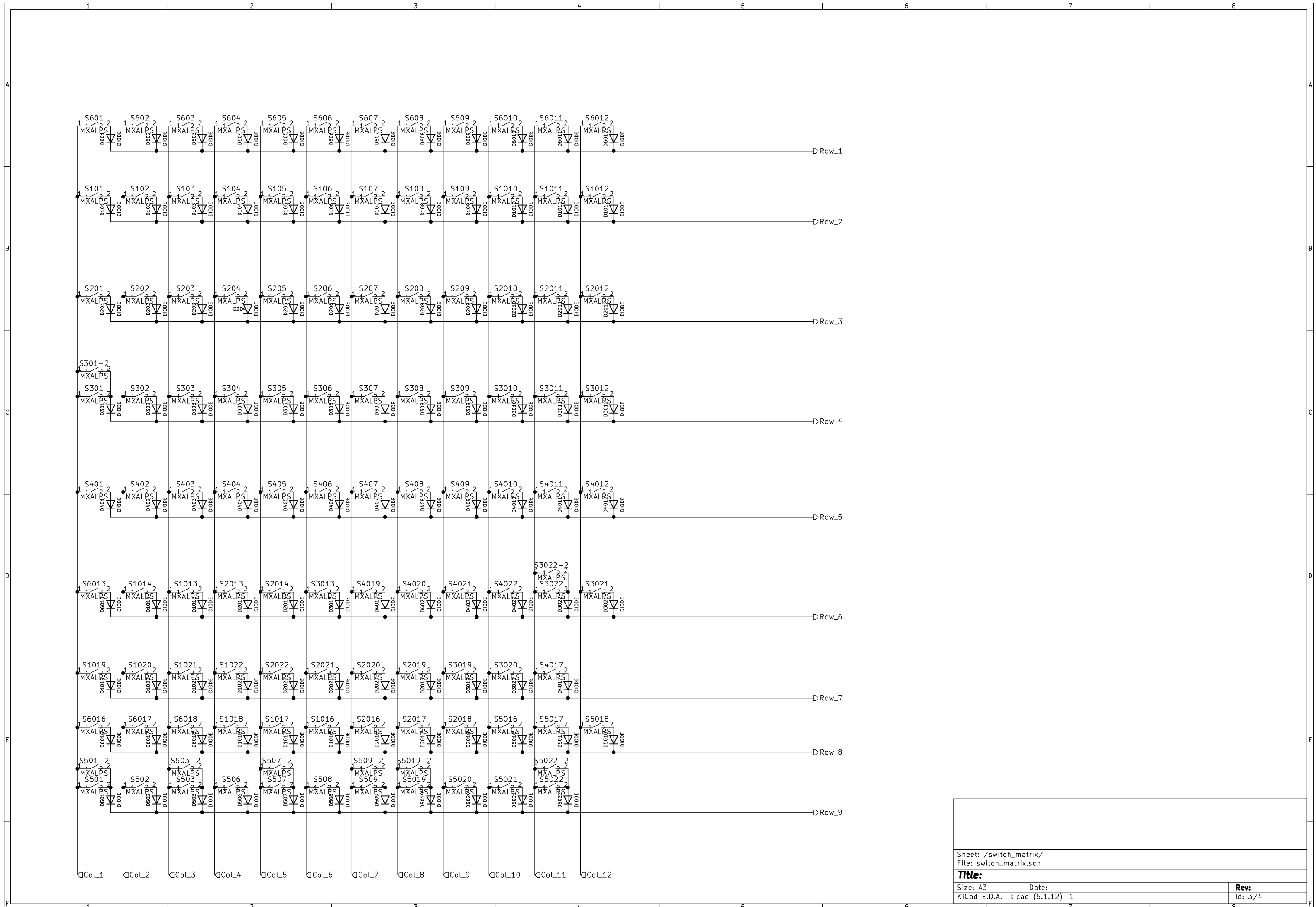

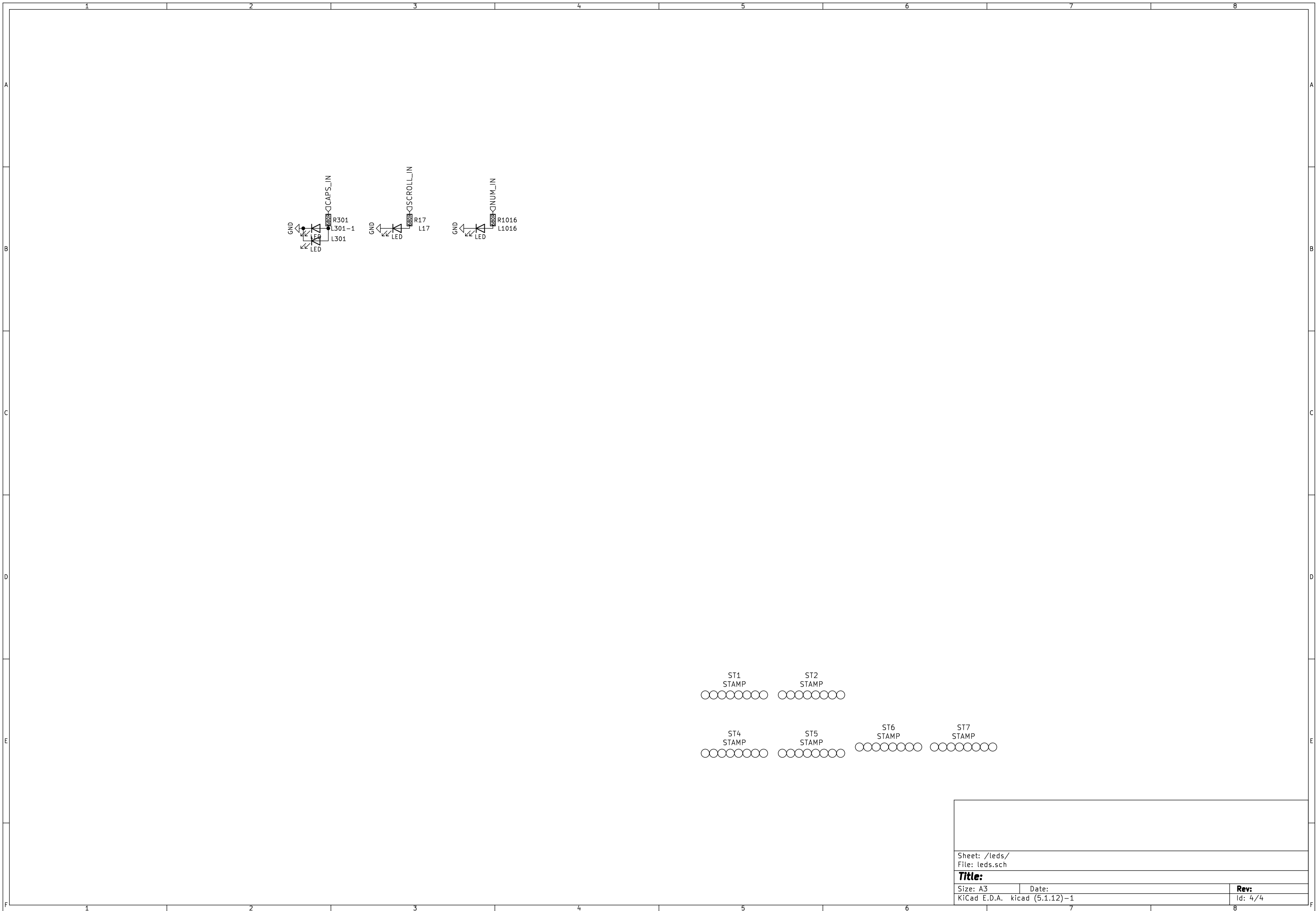

Sheet: /leds/ File: leds.sch		
<b>Title:</b>		
Size: A3	Date:	Rev:
KiCad E.D.A. kicad (5.1.12)-1		Id: 4/4