

T

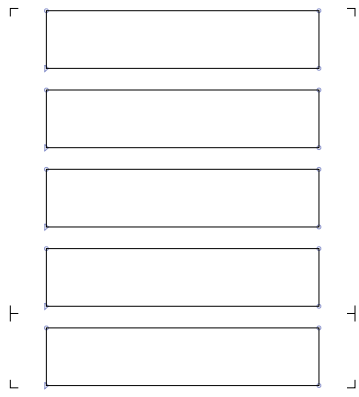

┌ ┐

┌ ┐

+

┌ ┐

┌ ┐

└ ┘

└ ┘

└ ┘

.null

.notdef

space

0020

nbspace

00A0

┌ ┐

┌ ┐

┌ ┐

┌ ┐

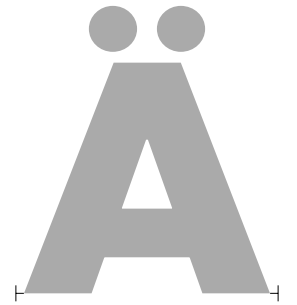
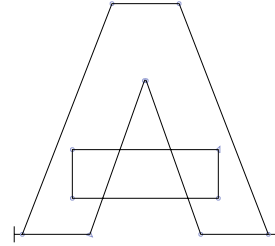

uni202F

202F

uni205F

205F

A

0041

Adieresis

00C4

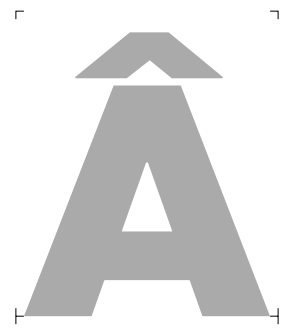

Atilde

00C3

Agrave

00C0

Aacute

00C1

Acircumflex

00C2

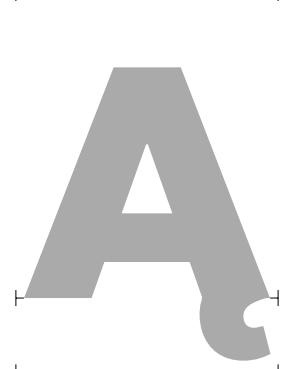

Aring

00C5

Amacron

0100

Abreve

0102

Aogonek

0104

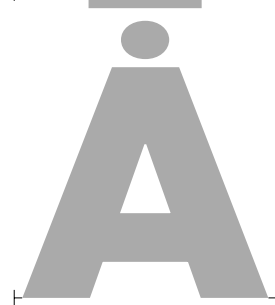

Acaron

01CD

Adieresismacron

01DE

Adotmacron

01E0

Aringacute

01FA

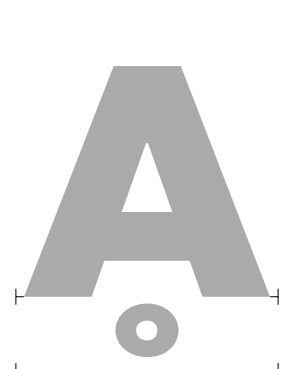
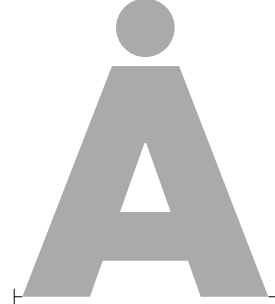

Adblgrave

0200

Ainvertedbreve

0202

uni0226

0226

Aringbelow

1E00

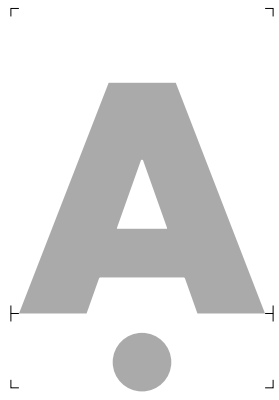

Adotbelow 1EA0

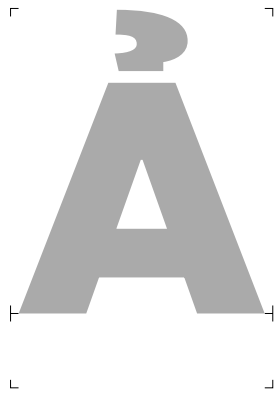

Ahookabove 1EA2

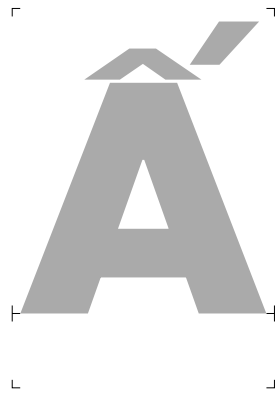

Acircumflexacute 1EA4

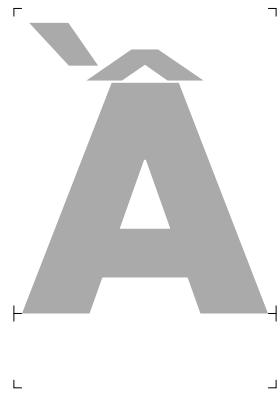

Acircumflexgrave 1EA6

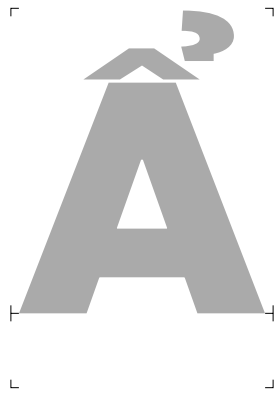

Acircumflexhookabove 1EA8

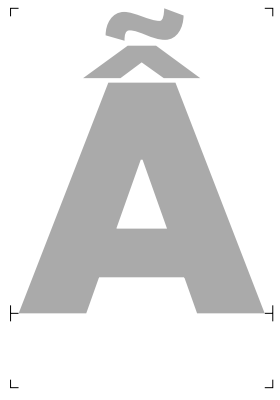

Acircumflextilde 1EAA

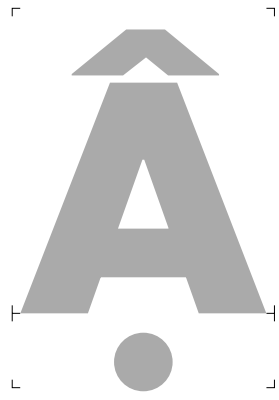

Acircumflexdotbelow 1EAC

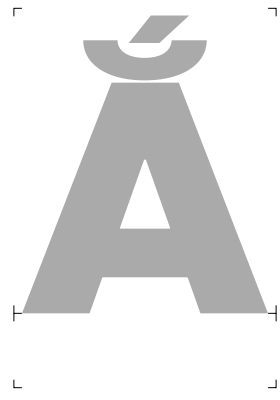

Abreveacute 1EAE

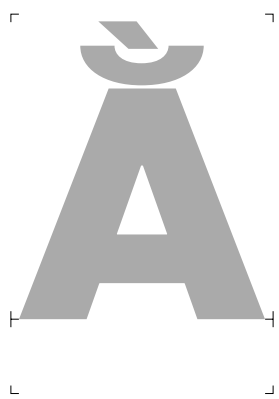

Abrevegrave 1EB0

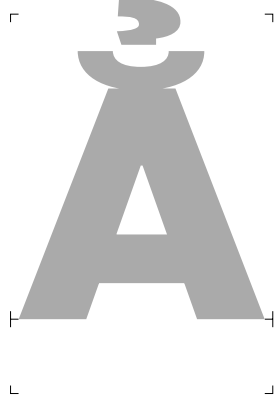

Abrevehookabove 1EB2

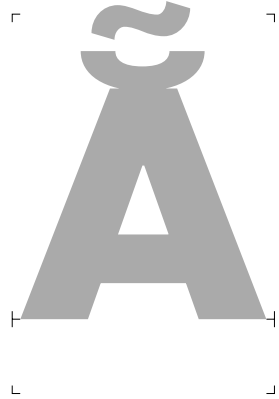

Abrevetilde 1EB4

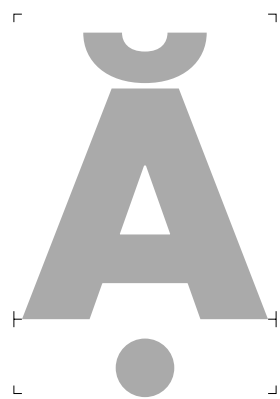

Abrevedotbelow 1EB6

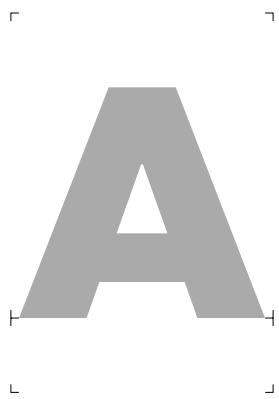

Alpha 0391

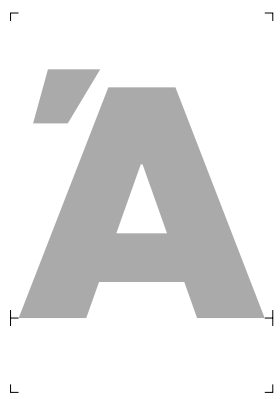

Alphatonos 0386

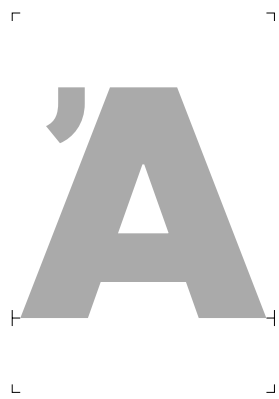

uni1F08 1F08

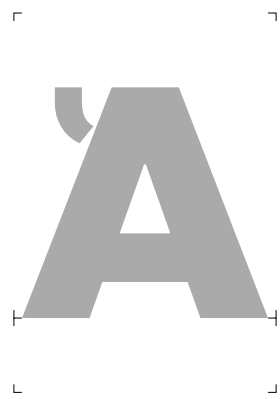

uni1F09 1F09

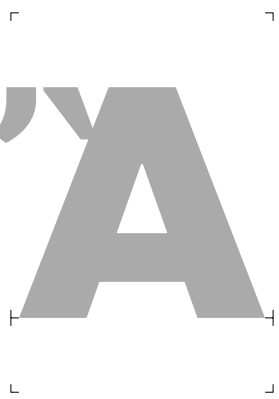

uni1F0A 1F0A



uni1F0B 1F0B

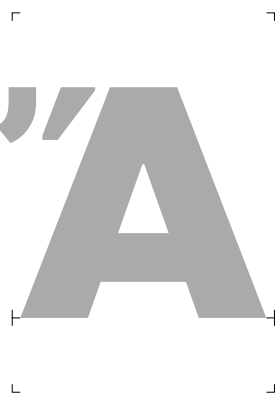

uni1F0C 1F0C

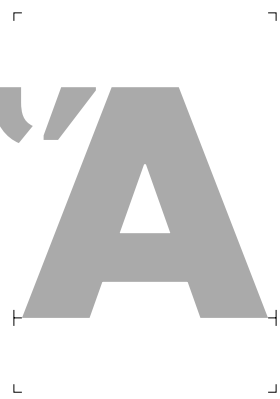

uni1F0D 1F0D

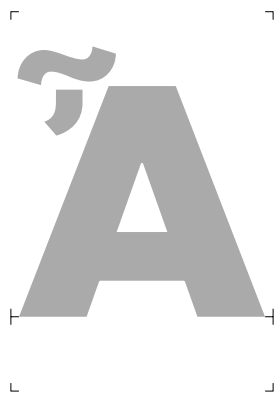

uni1F0E 1F0E

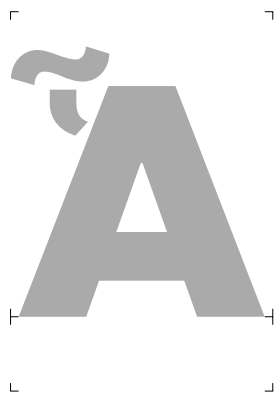

uni1F0F 1F0F

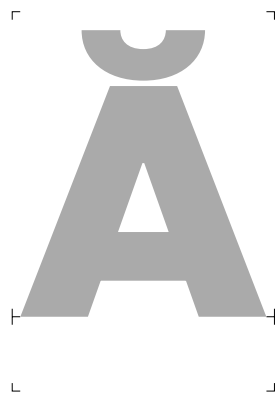

uni1FB8 1FB8

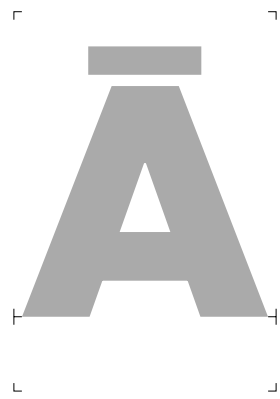

uni1FB9 1FB9



uni1FBA 1FBA

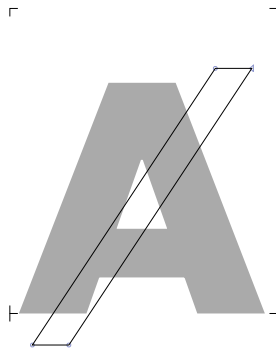

uni023A 023A



uni1FBB 1FBB



afii10017 0410

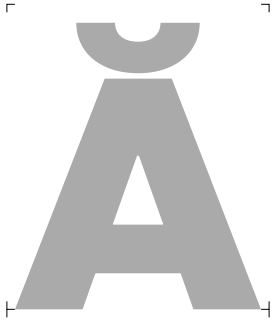

Abrevycyrillic 04D0

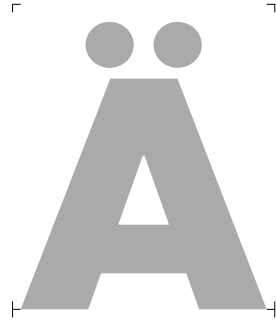

Adieresiscyrillic 04D2

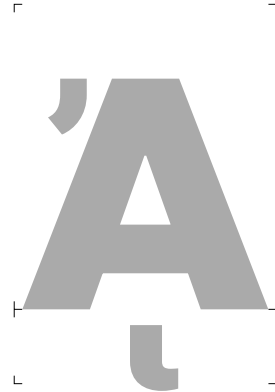

uni1F88 1F88



uni1F89 1F89

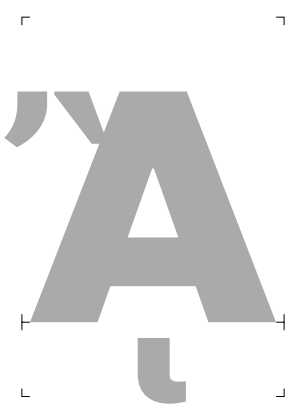

uni1F8A 1F8A



uni1F8B 1F8B



uni1F8C 1F8C

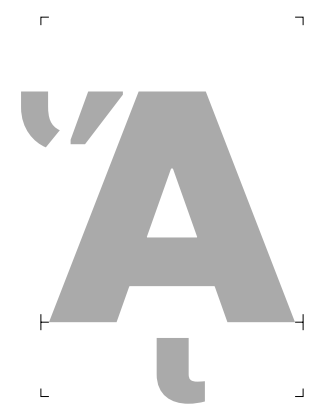

uni1F8D 1F8D

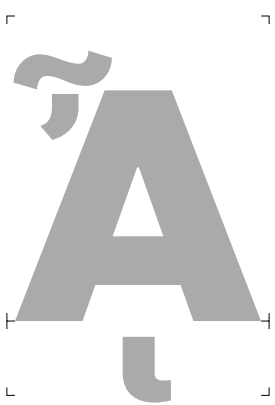

uni1F8E 1F8E

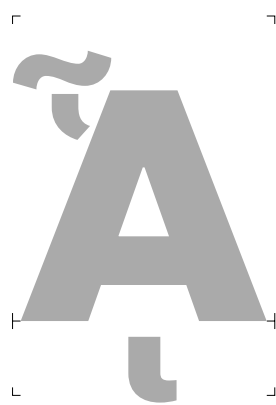

uni1F8F 1F8F

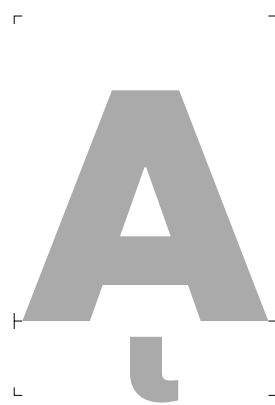

uni1FBC 1FBC

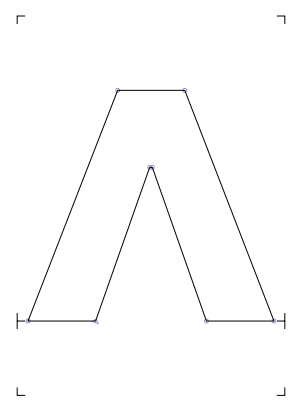

Lambda 039B

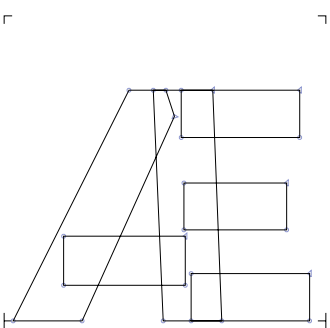

AE 00C6



AEmacron 01E2

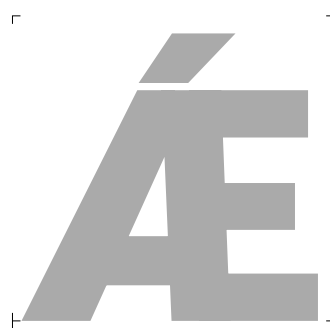

AEacute 01FC



Aicyrillic 04D4

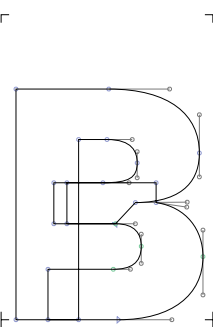

B 0042

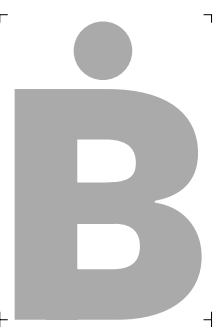

Bdotaccent 1E02



Bdotbelow 1E04



Blinebelow 1E06

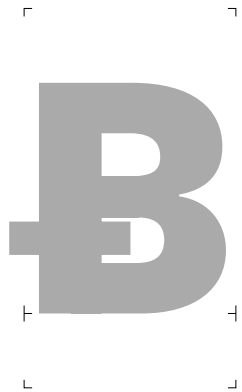

uni0243

0243

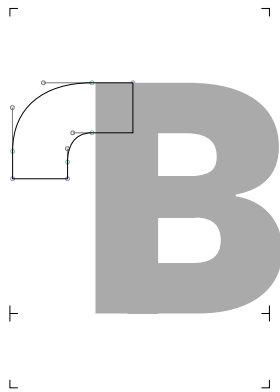

Bhook

0181

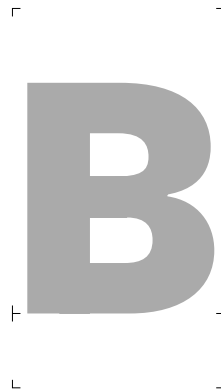

afii10019

0412

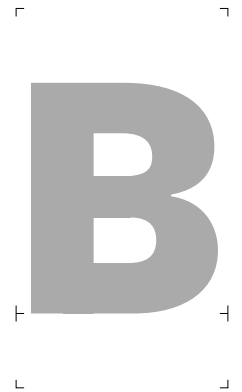

Beta

0392

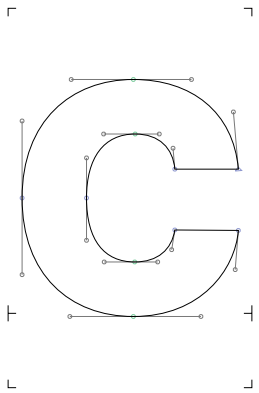

C

0043

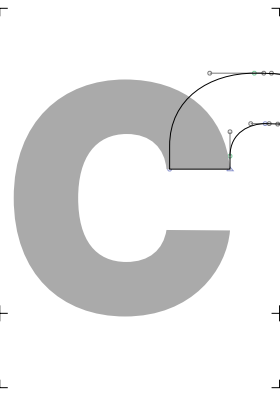

Chook

0187

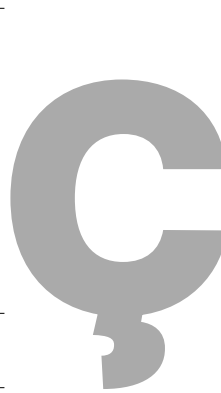

Ccedilla

00C7

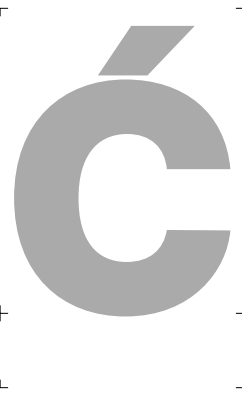

Cacute

0106

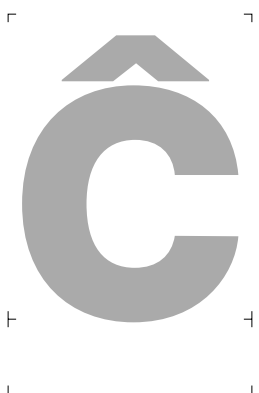

Ccircumflex

0108

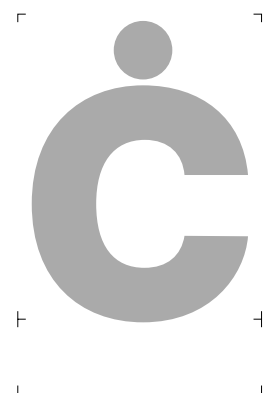

Cdotaccent

010A

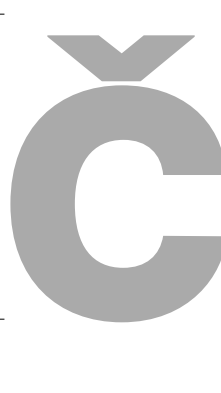

Ccaron

010C

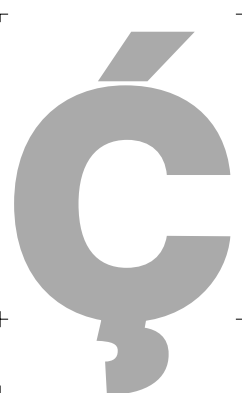

Ccedillaacute

1E08

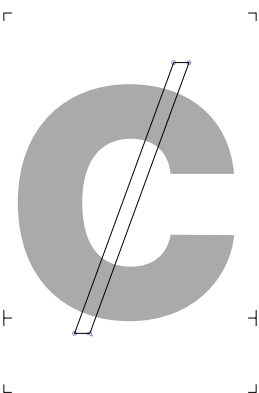

uni023B

023B

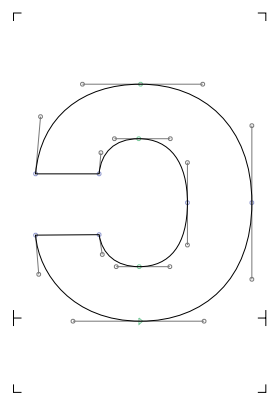

Open

0186

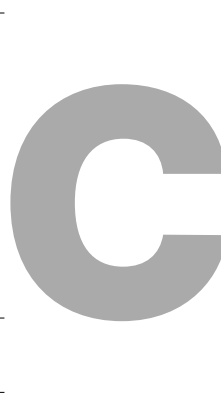

uni03F9

03F9

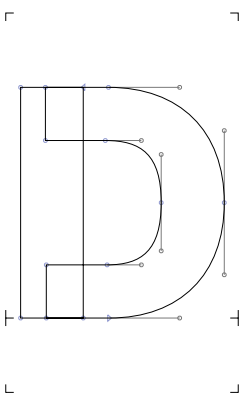

D

0044

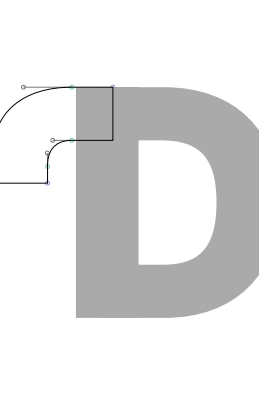

Dhook

018A

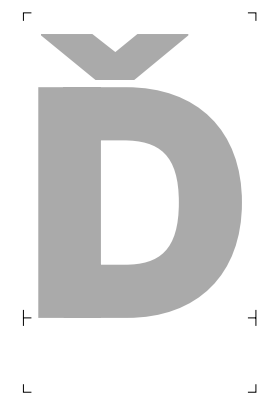

Dcaron

010E



Ddotaccent

1E0A

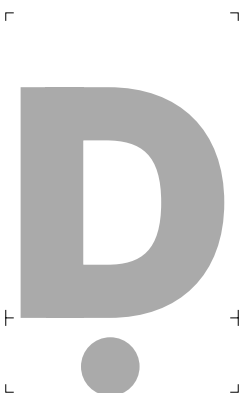

Ddotbelow

1E0C

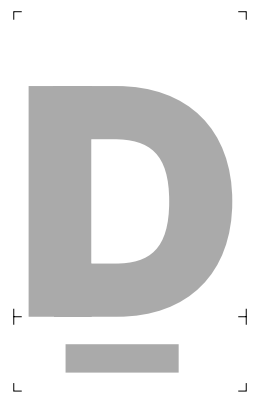

Dlinebelow

1E0E

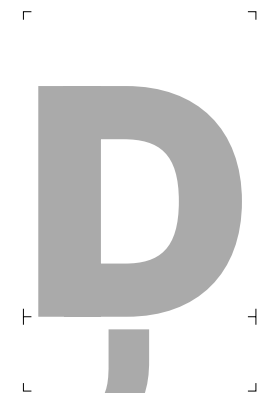

Dcedilla

1E10



Dcircumflexbelow

1E12

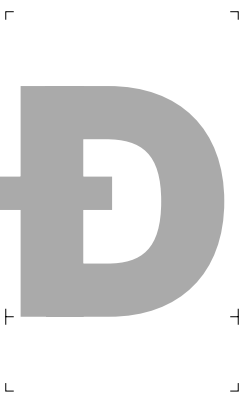

Dbar1

0189



Dz 01F2



Dzcaron_ 01C5

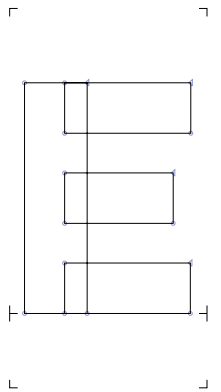

E 0045

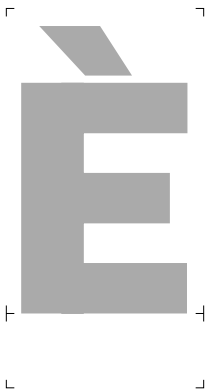

Egrave 00C8

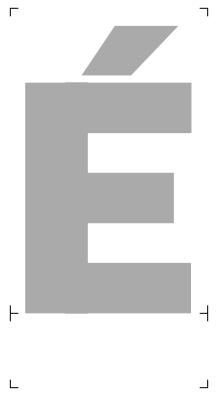

Eacute 00C9

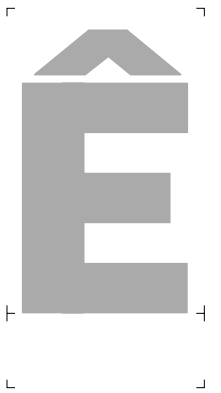

Ecircumflex 00CA

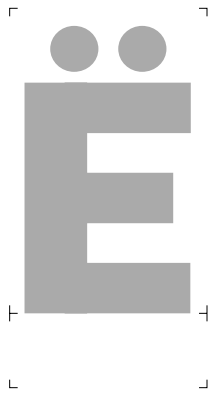

Edieresis 00CB

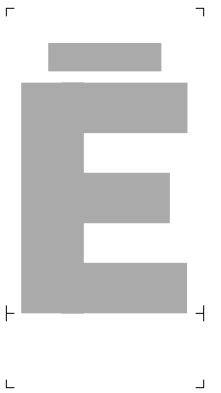

Emacron 0112



Ebreve 0114



Edotaccent 0116

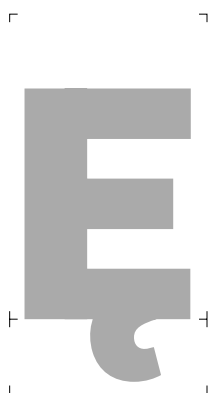

Eogonek 0118



Ecaron 011A



Edblgrave 0204



Einvertedbreve 0206



uni0228 0228



Emacrongrave 1E14



Emacronacute 1E16



Ecircumflexbelow 1E18



Etildebelow 1E1A



Ecedillabreve 1E1C



Edotbelow 1E88



Ehookabove 1E8A



Etilde 1EBC



Ecircumflexacute 1E8E



Ecircumflexgrave 1EC0



Ecircumflexhookabove 1EC2



Ecircumflexilde 1EC4



Ecircumflexdotbelow 1EC6

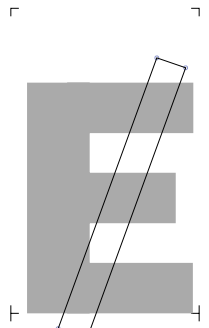

uni0246 0246

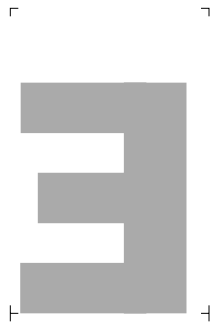

Eturn 018E



Epsilon 0395



Epsilontonos 0388



uni1F18 1F18



uni1F19 1F19



uni1F1A 1F1A



uni1F1B 1F1B



uni1F1C 1F1C



uni1F1D 1F1D



uni1FC8 1FC8



uni1FC9 1FC9



afi10022 0415



uni0400 0400



afi10023 0401



lebrevecyrillic 04D6

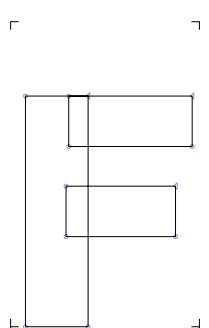

F 0046



Fhook 0191



Fdotaccent 1E1E



Fturn 2132

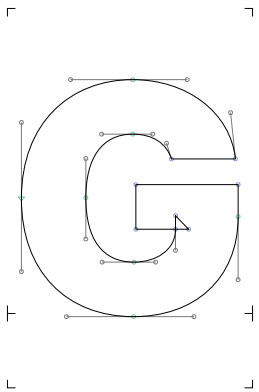

G 0047

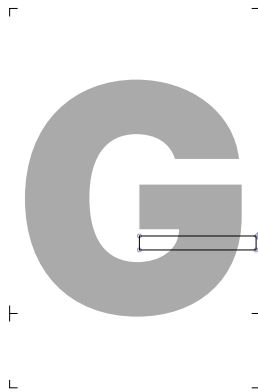

Gbar 01E4

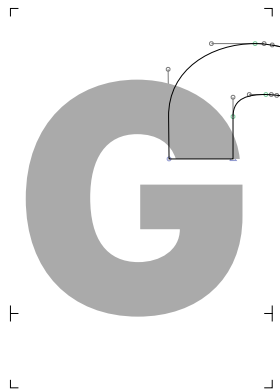

Ghook 0193



Gcircumflex 011C

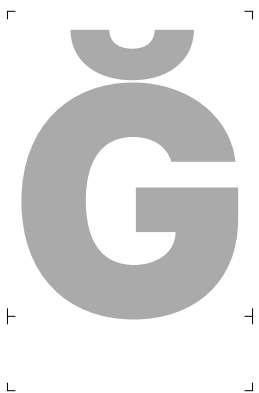

Gbreve 011E

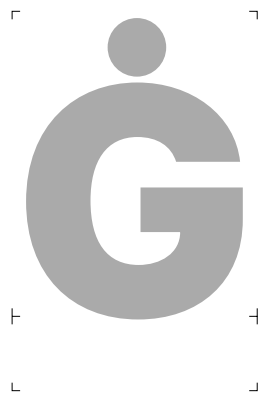

Gdotaccent 0120



Gcommaaccent 0122

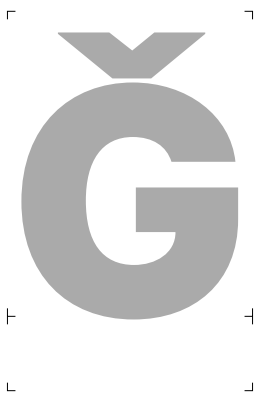

Gcaron 01E6

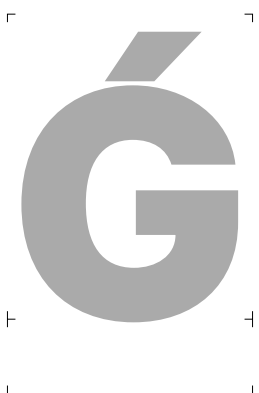

Gacute 01F4



Gmacron 1E20

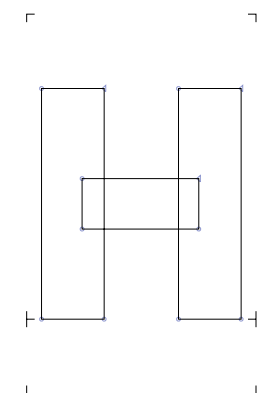

H 0048

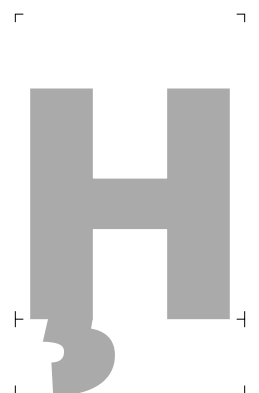

Hcedilla 1E28

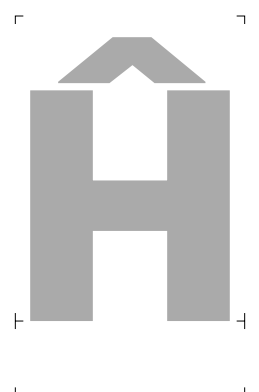

Hcircumflex 0124

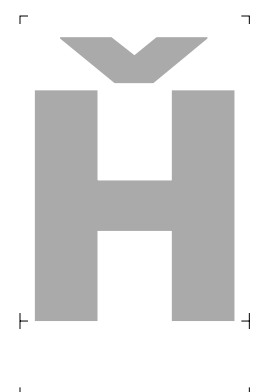

uni021E 021E

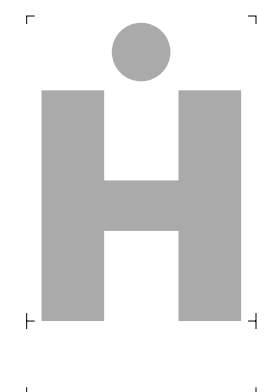

Hdotaccent 1E22

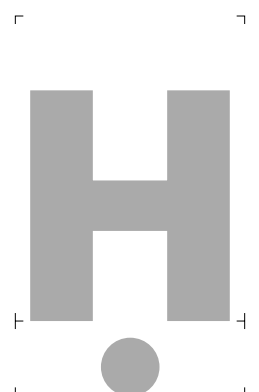

Hdotbelow 1E24

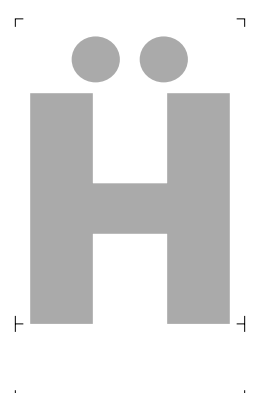

Hdieresis 1E26

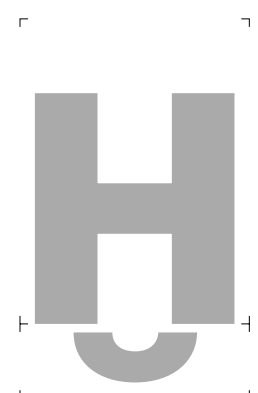

Hbrevebelow 1E2A

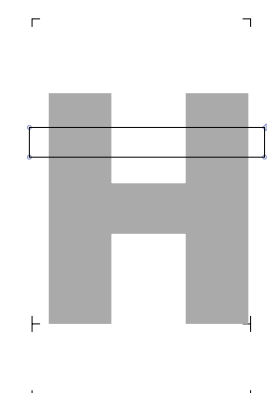

Hbar 0126

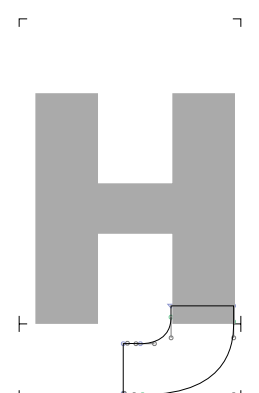

Enhookcyrillic 04C7



Endescendercyrillic 04A2



uni04C9 04C9

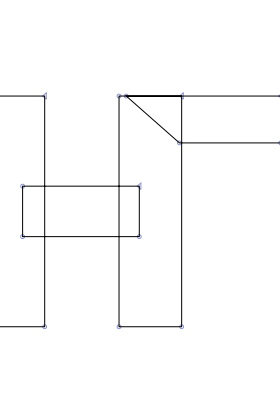

Enghecyrillic 04A4

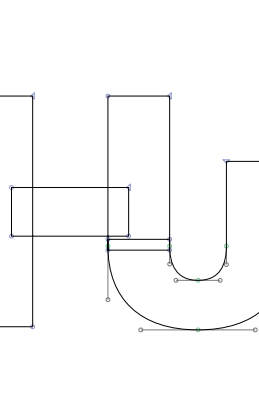

uni01F6 01F6

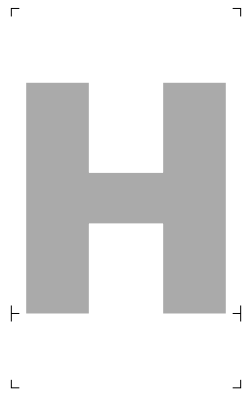

Eta 0397

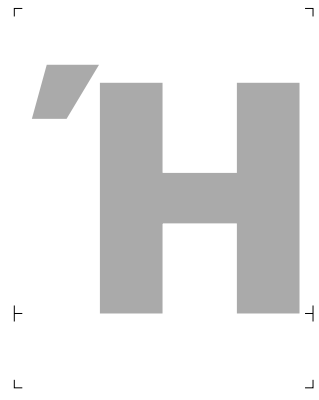

Eatonos 0389



uni1F28 1F28

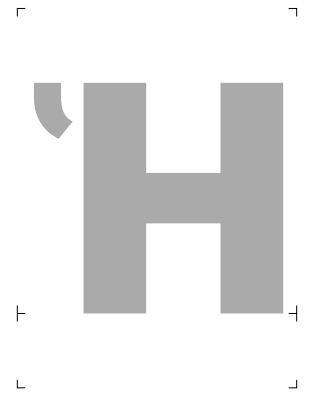

uni1F29 1F29



uni1F2A 1F2A

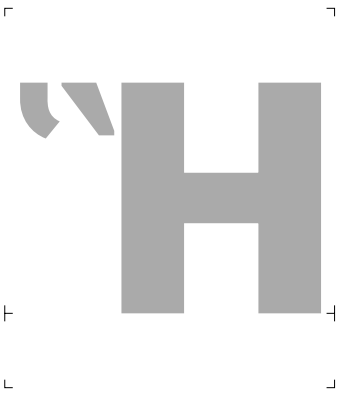

uni1F2B 1F2B



uni1F2C 1F2C



uni1F2D 1F2D



uni1F2E 1F2E

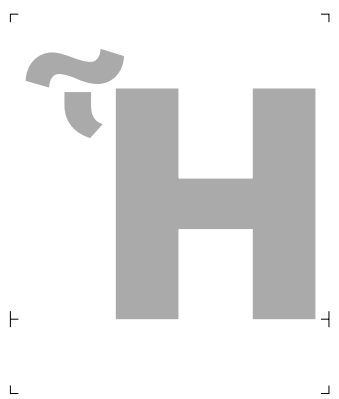

uni1F2F 1F2F



uni1FCA 1FCA

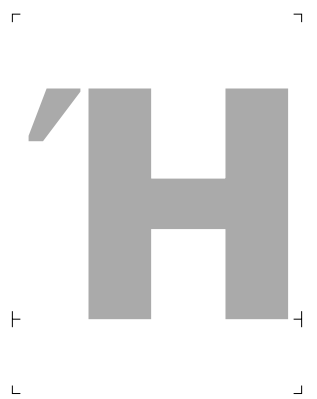

uni1FCB 1FCB

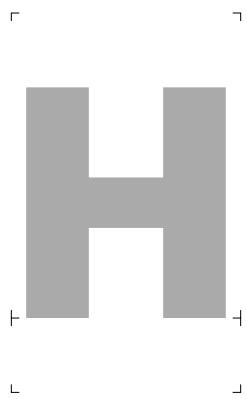

afii10031 041D

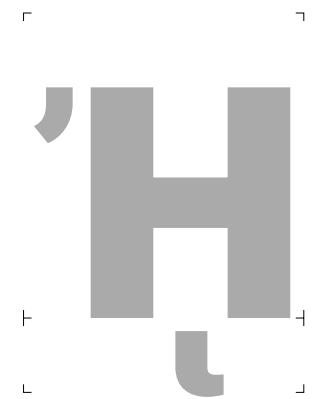

uni1F98 1F98

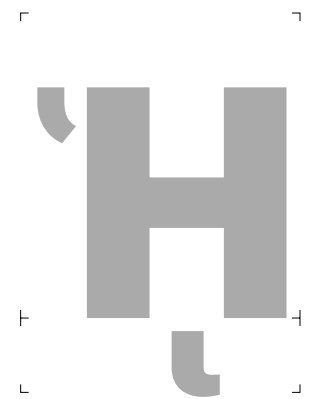

uni1F99 1F99



uni1F9A 1F9A



uni1F9B 1F9B



uni1F9C 1F9C



uni1F9D 1F9D



uni1F9E 1F9E

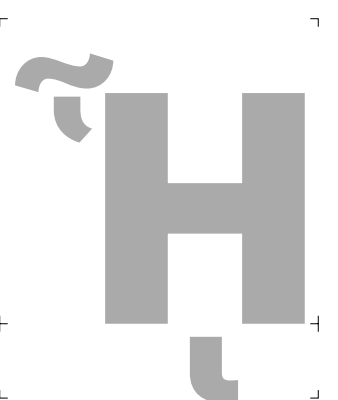

uni1F9F 1F9F

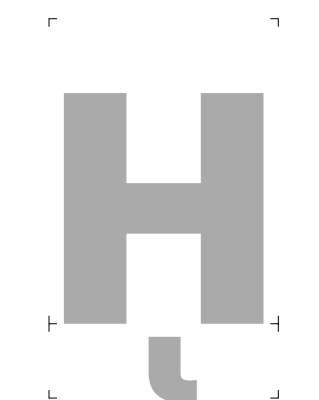

uni1FCC 1FCC

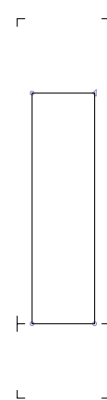

I 0049



Idieresis 00CF



Idieresisacute

1E2E



Istroke

0197



Itildebelow

1E2C



Igrave

00CC



Iacute

00CD



Icircumflex

00CE



Itilde

0128



Imacron

012A



Ibreve

012C



Iogonek

012E



Idotaccent

0130



Icaron

01CF



Idblgrave

0208

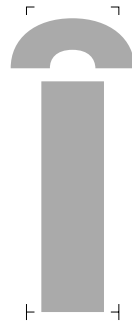

Iinvertedbreve

020A



Ihookabove

1EC8



Idotbelow

1ECA



Iota

0399



Iotatonos

038A



Iotadieresis

03AA



uni1F38

1F38



uni1F39

1F39



uni1F3A

1F3A



uni1F3B

1F3B



uni1F3C

1F3C

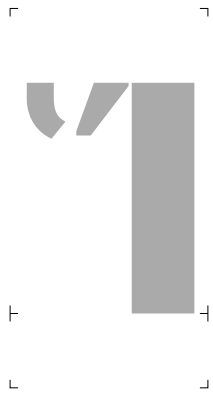

uni1F3D

1F3D

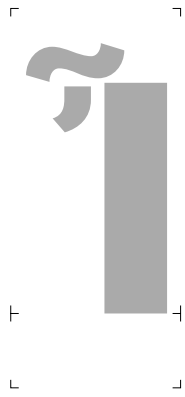

uni1F3E

1F3E



uni1F3F

1F3F



uni1FD8

1FD8



uni1FD9

1FD9

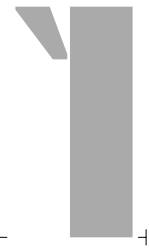

uni1FDA

1FDA



uni1FDB

1FDB

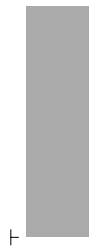

afii10055

0406



afii10056

0407

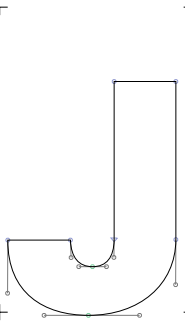

J

004A



Jcircumflex

0134



uni0248

0248



uni037F

037F

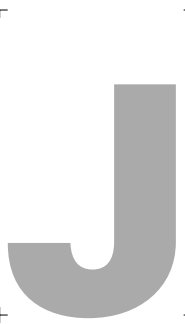

afii10057

0408

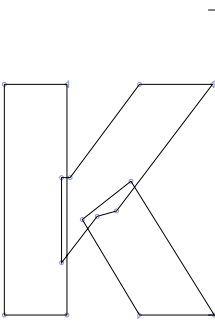

K

004B



Kcommaaccent

0136



Kcaron

01E8

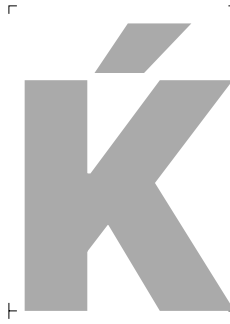

Kacute

1E30

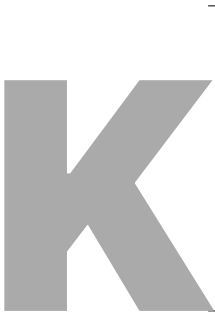

Kdotbelow

1E32



Klinebelow

1E34

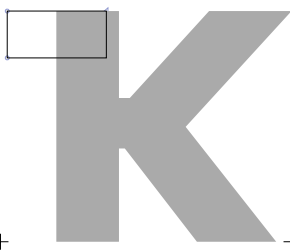

Kabashkircyrillic

04A0

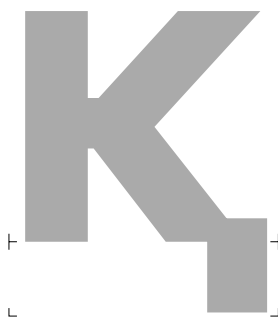

Kadescendcyrillic

049A

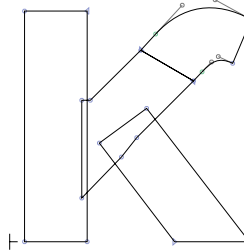

Khook

0198



Kappa

039A

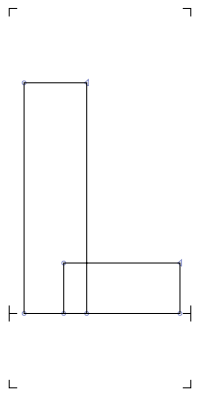

L 004C



Lacute 0139



Lcommaaccent 013B



Lcaron 013D



Ldotbelow 1E36



Ldotbelowmacron 1E38

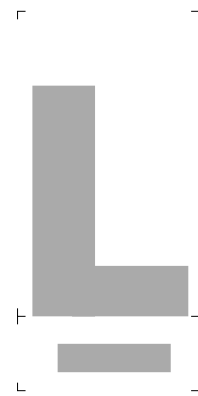

Llinebelow 1E3A



Lcircumflexbelow 1E3C

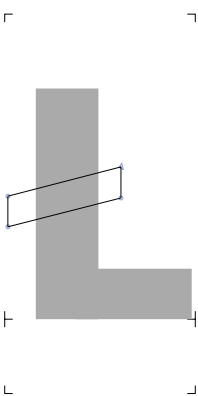

Lslash 0141



Lbar 023D



Lj 01C8

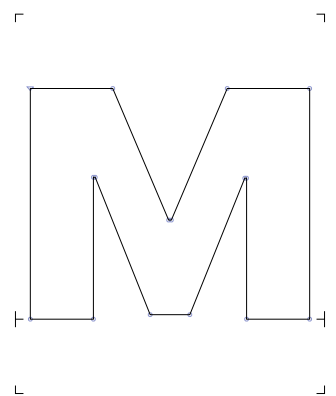

M 004D

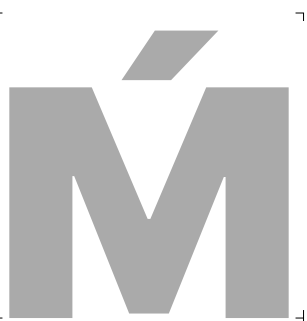

Macute 1E3E



Mdotaccent 1E40



Mdotbelow 1E42



uni04CD 04CD



Mu 039C



uni03FA 03FA



afi10030 041C

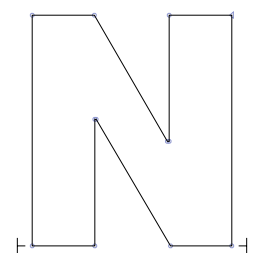

N 004E



Ntilde 00D1



Nacute 0143



Ncommaaccent 0145



Ncaron 0147

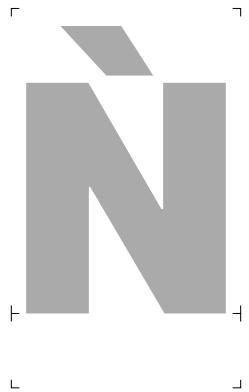

uni01F8

01F8

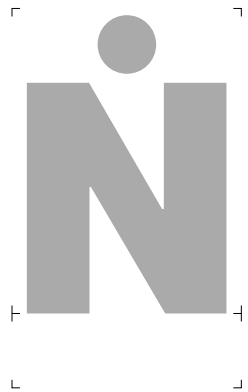

Ndotaccent

1E44

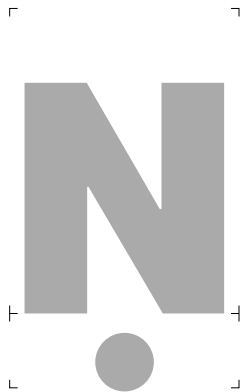

Ndotbelow

1E46

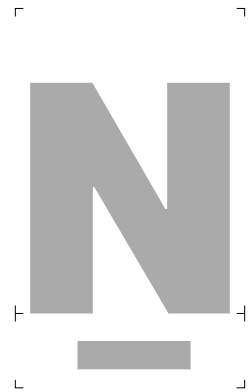

Nlinebelow

1E48

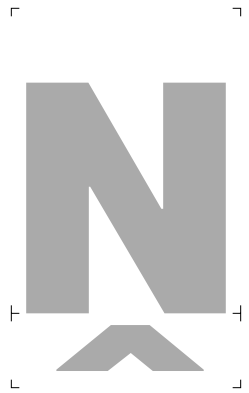

Ncircumflexbelow

1E4A

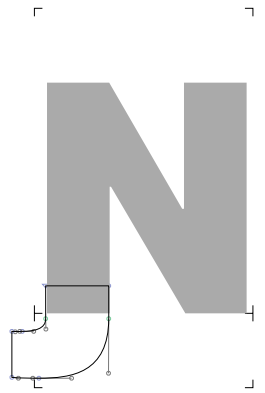

Nhook

019D

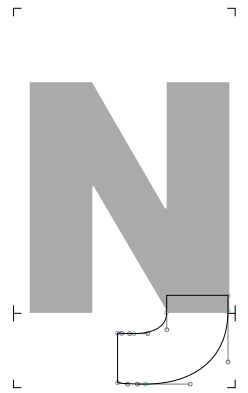

Eng

014A

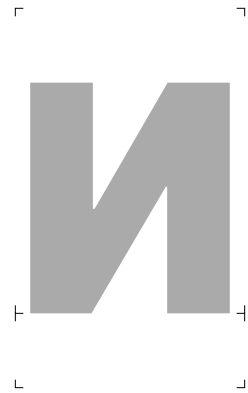

afii10026

0418

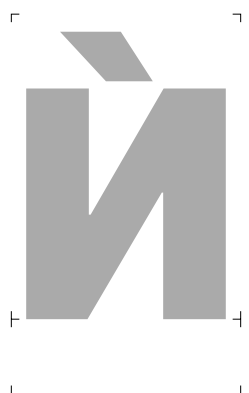

uni040D

040D

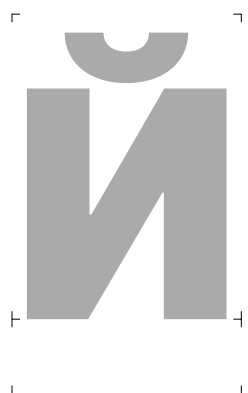

afii10027

0419

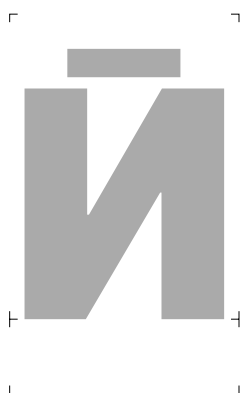

Imacroncyrillic

04E2

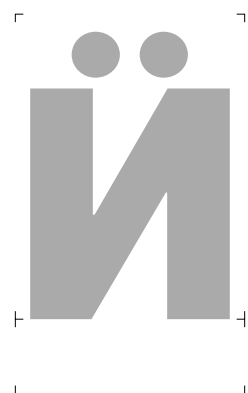

Idieresiscyrillic

04E4

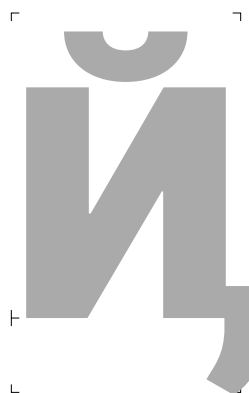

uni048A

048A

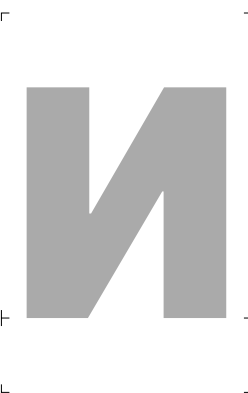

uni0376

0376

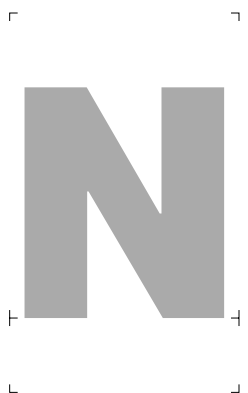

Nu

039D



Nj

01CB

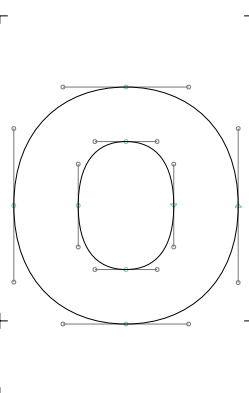

O

004F

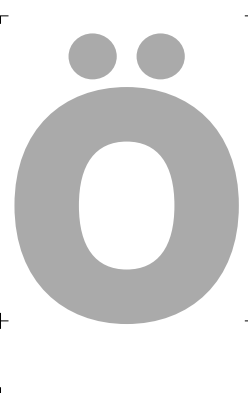

Odieresis

00D6



Otilde

00D5

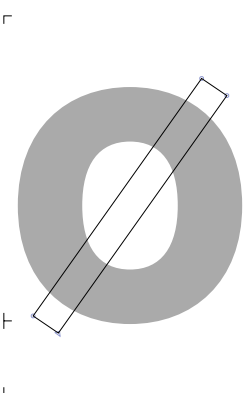

Oslash

00D8

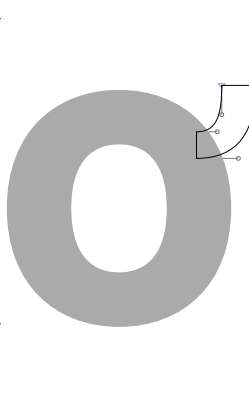

Ohorn

01A0

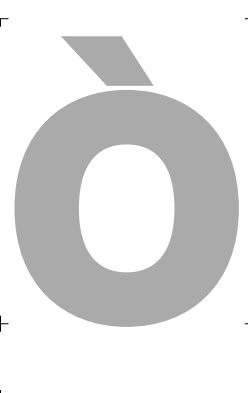

Ograve

00D2

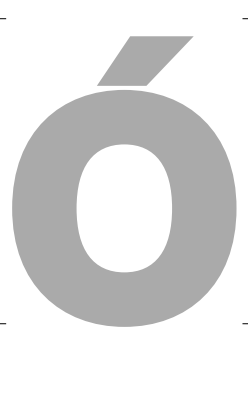

Oacute

00D3

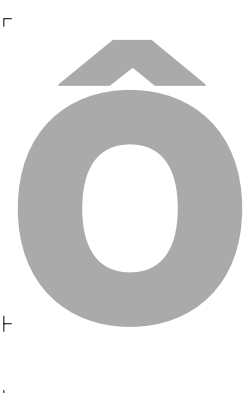

Ocircumflex

00D4

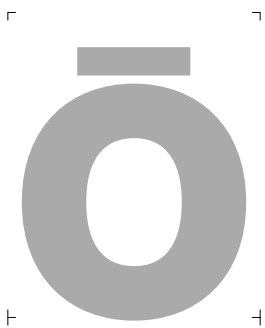

Omacron 014C

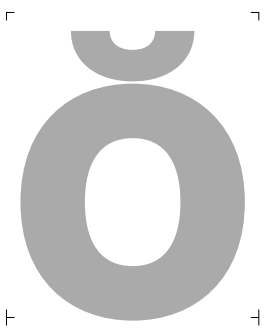

Obreve 014E



Ohungarumlaut 0150

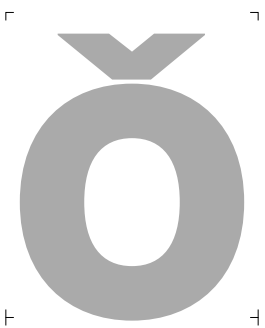

Ocaron 01D1

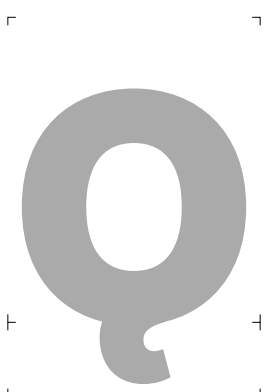

Oogonek 01EA

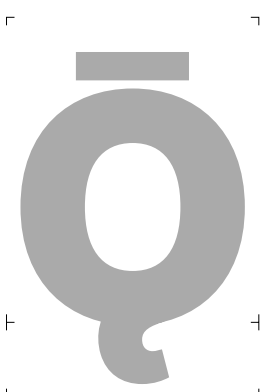

Oogonekmacron 01EC

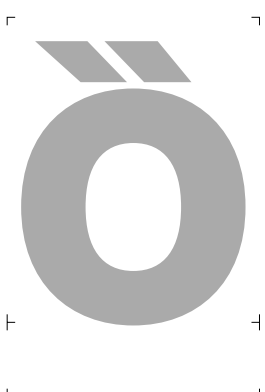

Odblgrave 020C

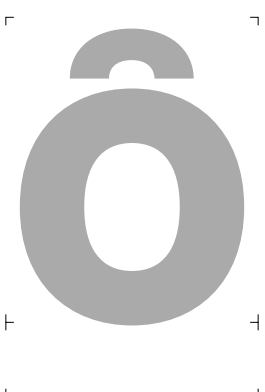

Oinvertedbreve 020E

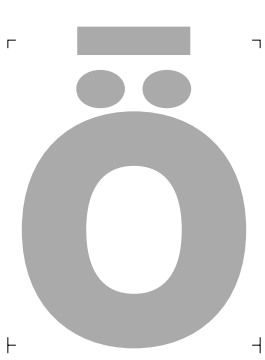

uni022A 022A

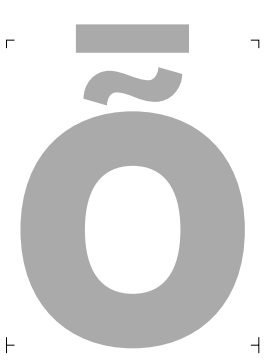

uni022C 022C

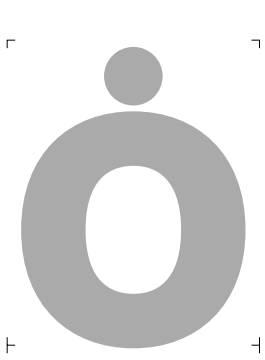

uni022E 022E

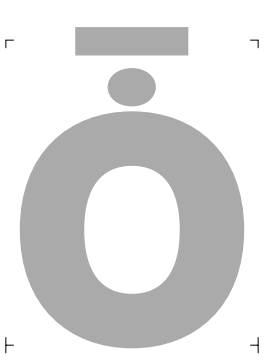

uni0230 0230



Otildeacute 1E4C

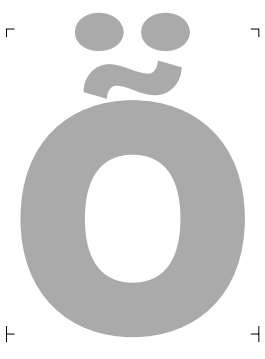

Otildedieresis 1E4E

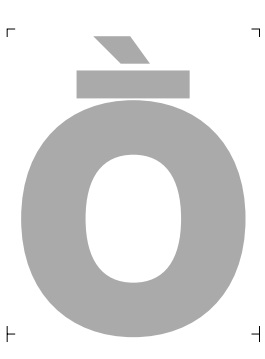

Omacrongrave 1E50

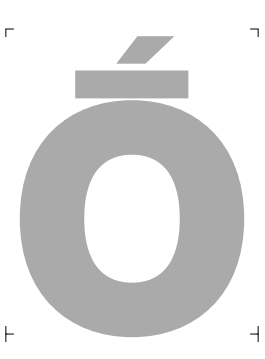

Omacronacute 1E52

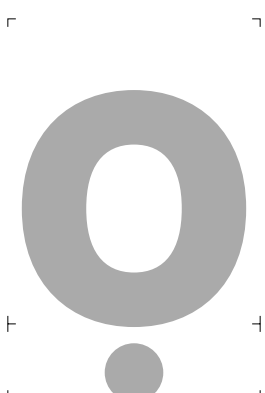

Odotbelow 1ECC

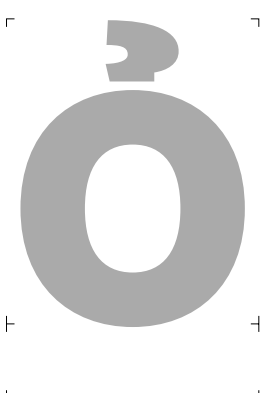

Ohookabove 1ECE

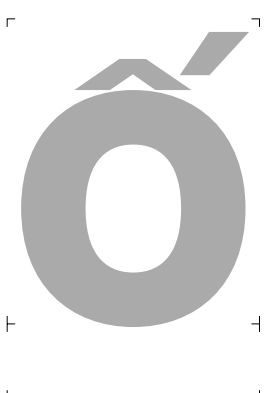

Ocircumflexacute 1ED0

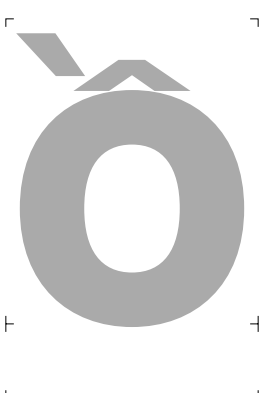

Ocircumflexgrave 1ED2

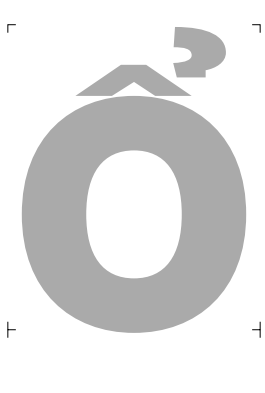

Ocircumflexhookabove 1ED4

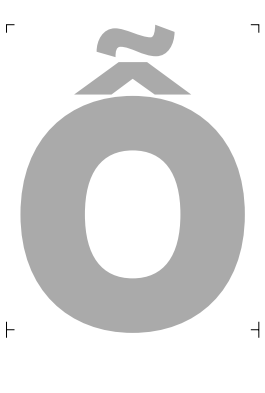

Ocircumflextilde 1ED6

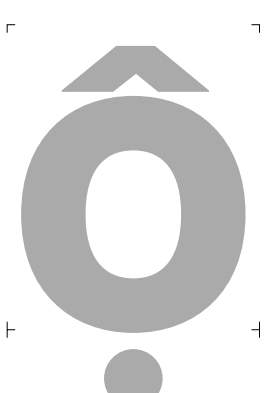

Ocircumflexdotbelow 1ED8



Ohornacute 1EDA

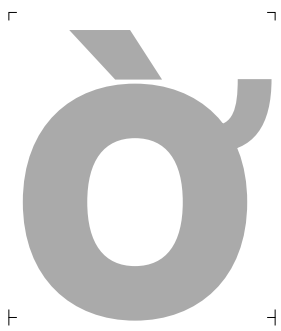

Ohorngrave 1EDC



Ohornhookabove 1EDE



Ohorntilde 1EE0



Ohorndotbelow 1EE2

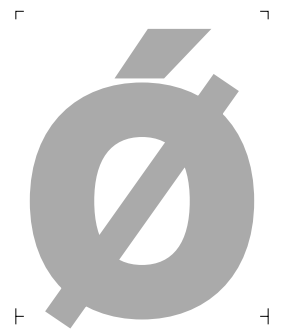

Oslashacute 01FE

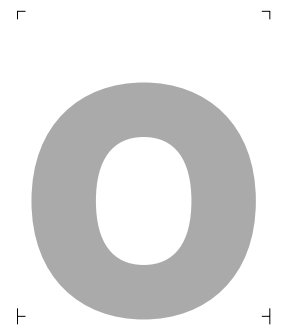

Omicron 039F



Omicrontonos 038C



uni1F48 1F48



uni1F49 1F49

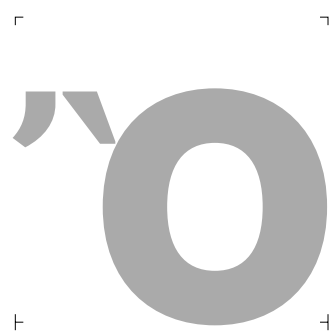

uni1F4A 1F4A

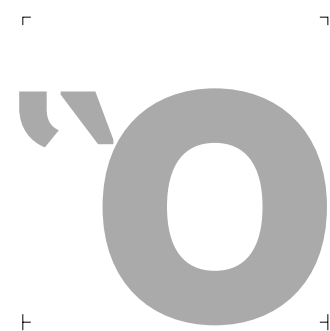

uni1F4B 1F4B

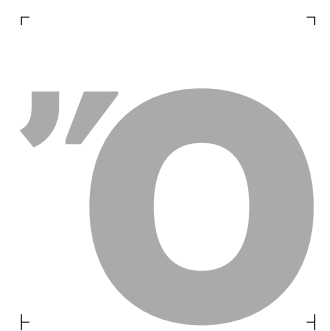

uni1F4C 1F4C

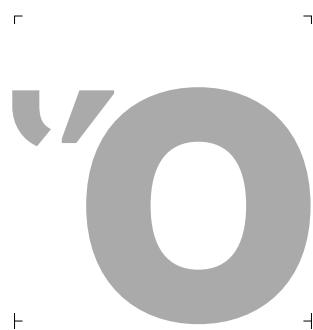

uni1F4D 1F4D



uni1FF8 1FF8



uni03F4 03F4



uni1FF9 1FF9

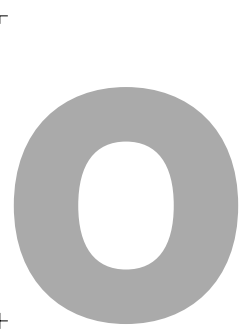

afi10032 041E

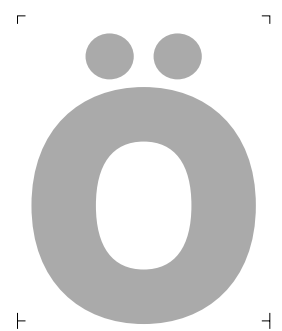

Odiereiscyrillic 04E6



Obar 019F



Obarredcyrillic 04E8



Obarreddieresiscyrillic 04EA

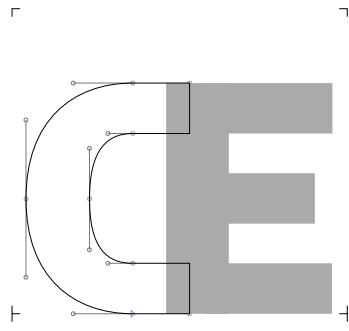

OE 0152

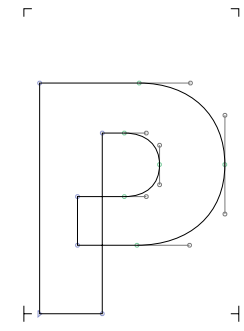

P 0050

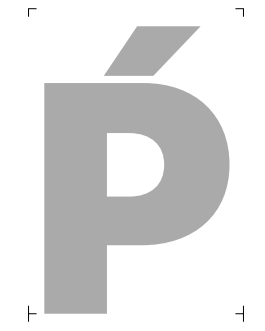

Pacute 1E54

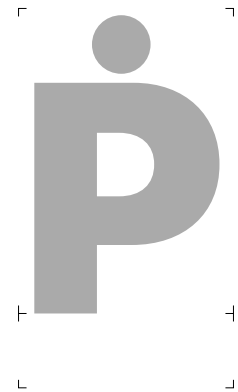

Pdotaccent

1E56

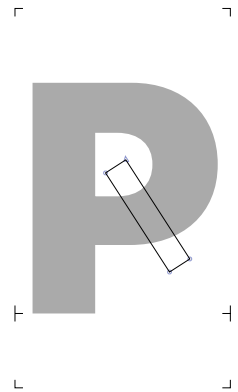

uni048E

048E

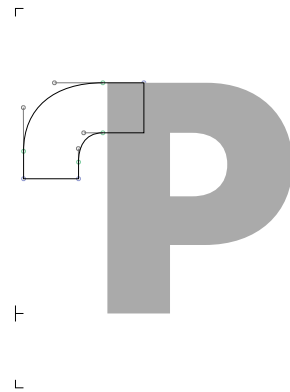

Phook

01A4

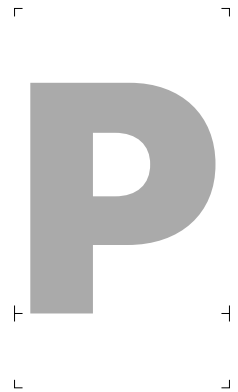

Rho

03A1



uni1FEC

1FEC

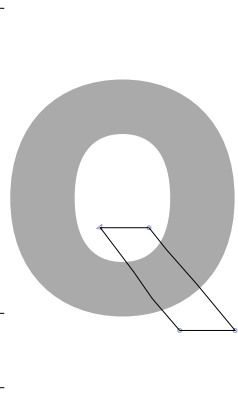

Q

0051

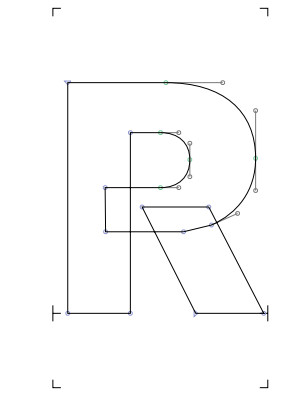

R

0052

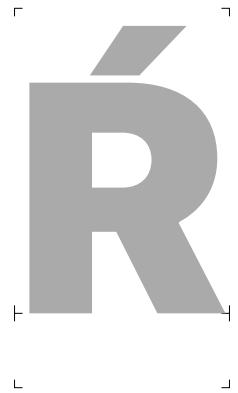

Racute

0154



Rcommaaccent

0156



Rcaron

0158



Rdblgrave

0210



Rinvertedbreve

0212



Rdotaccent

1E58



Rdotbelow

1E5A



Rdotbelowmacron

1E5C



Rlinebelow

1E5E

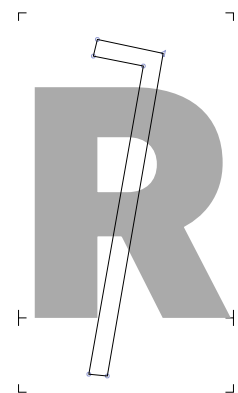

response

211F

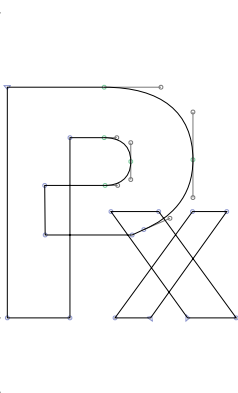

Rx

211E

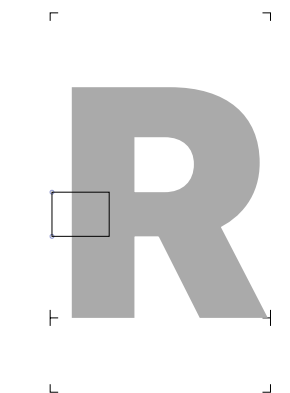

uni024C

024C

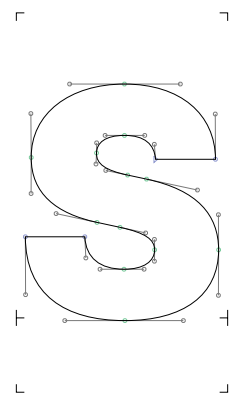

S

0053



Scute

015A



Scircumflex

015C



Scedilla

015E



Scaron

0160



Scommaaccent 0218

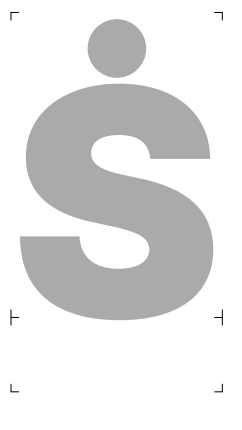

Sdotaccent 1E60



Sdotbelow 1E62



Sacutedotaccent 1E64



Scarondotaccent 1E66



Sdotbelowdotaccent 1E68



afii10054 0405



Tonetwo 01A7

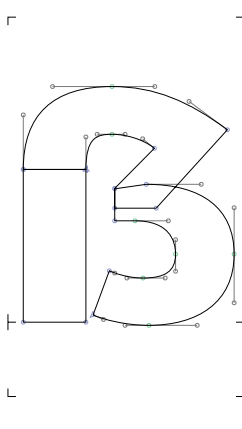

Germandbls 1E9E

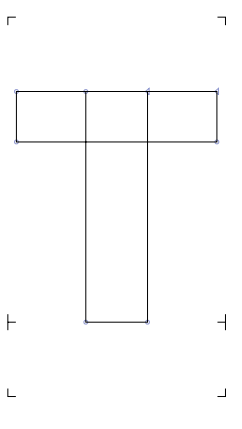

T 0054

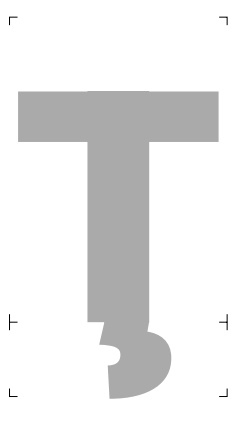

Tcommaaccent 0162

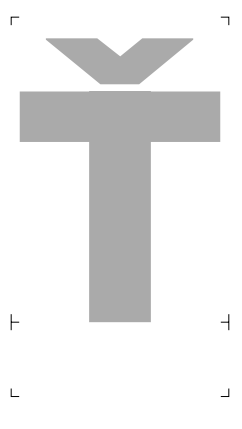

Tcaron 0164

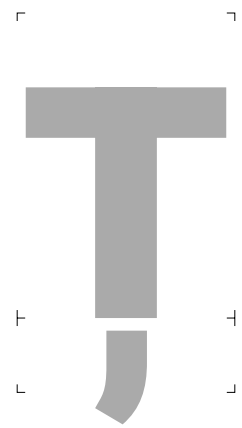

uni021A 021A

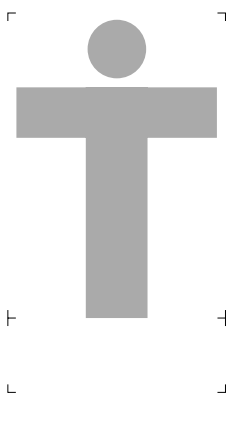

Tdotaccent 1E6A

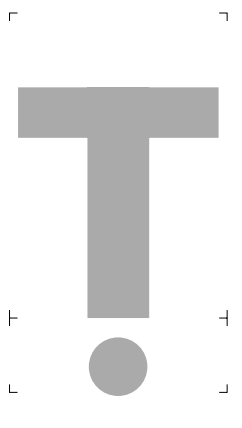

Tdotbelow 1E6C

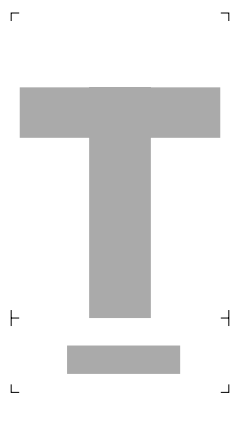

Tlinebelow 1E6E

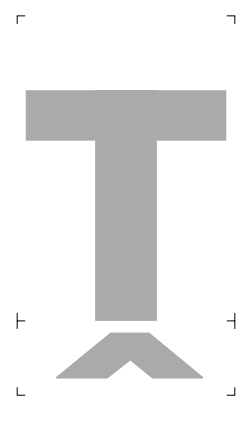

Tcircumflexbelow 1E70

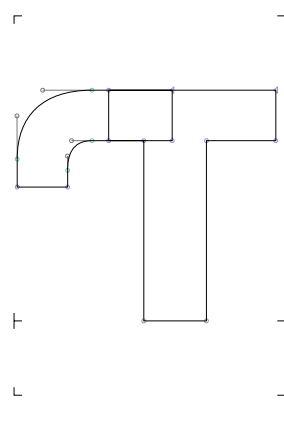

Thook 01AC

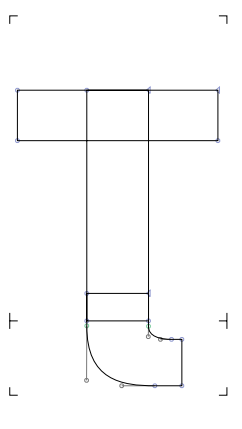

Trhook 01AE

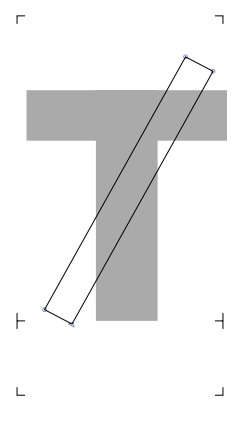

uni023E 023E

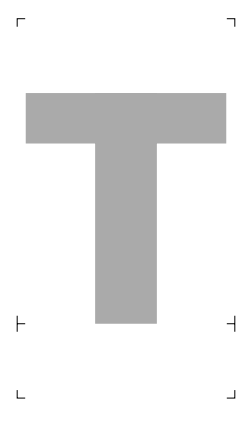

Tau 03A4

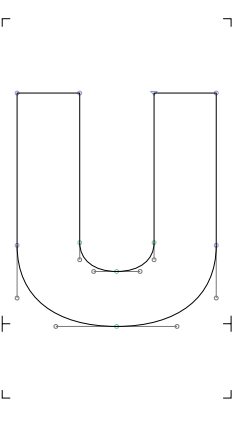

U 0055

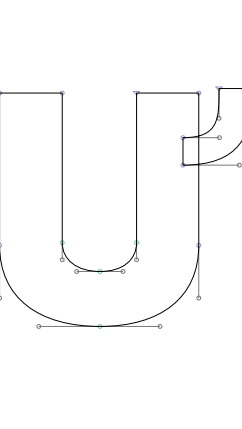

Uhorn 01AF

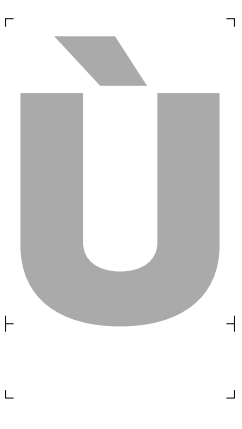

Ugrave 00D9

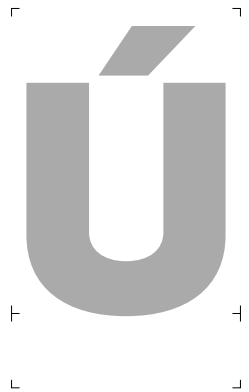

Uacute

00DA



Ucircumflex

00DB

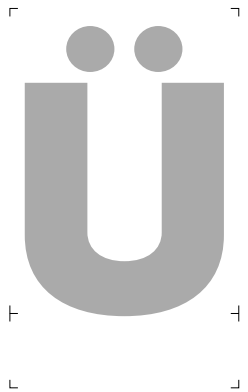

Udieresis

00DC

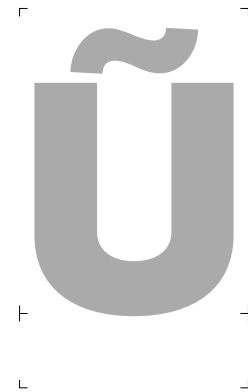

Utilde

0168

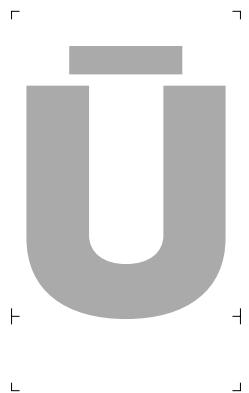

Umacron

016A

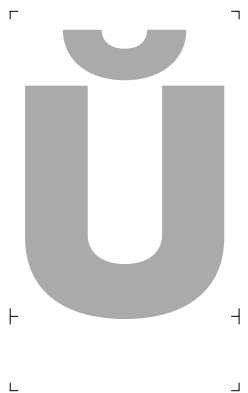

Ubreve

016C

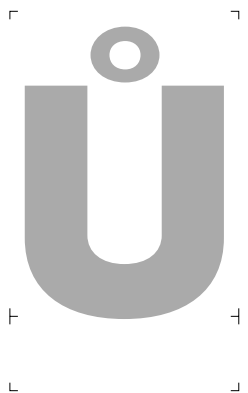

Uring

016E

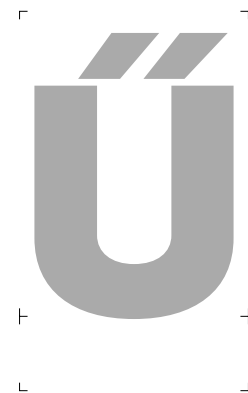

Uhungarumlaut

0170

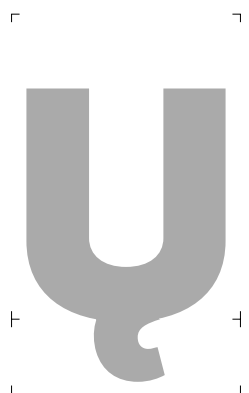

Uogonek

0172

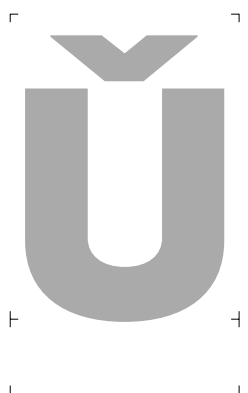

Ucaron

01D3

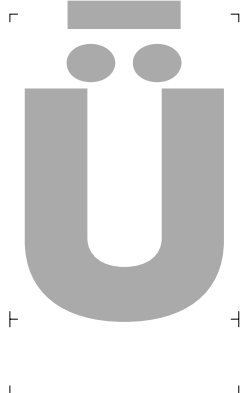

Udieresismacron

01D5

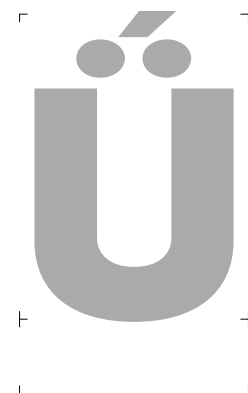

Udieresisacute

01D7

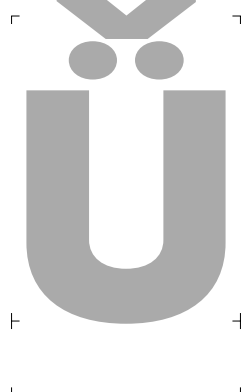

Udieresiscaron

01D9



Udieresisgrave

01DB



Udblgrave

0214



Uinvertedbreve

0216

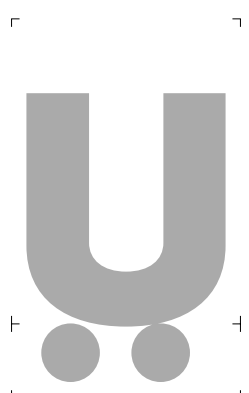

Udieresisbelow

1E72

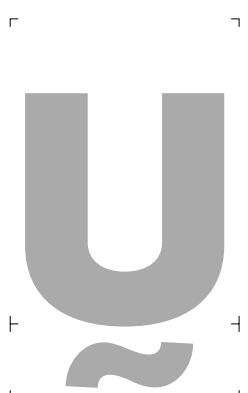

Utildebelow

1E74

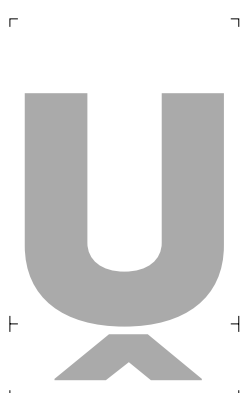

Ucircumflexbelow

1E76

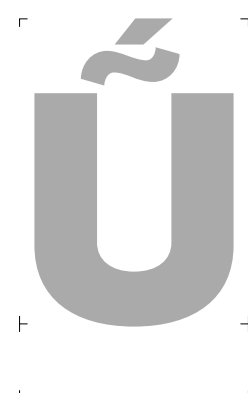

Utildeacute

1E78

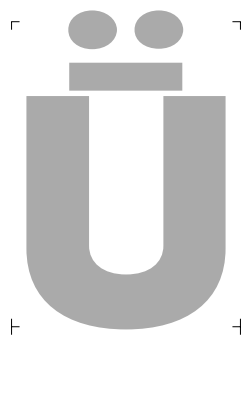

Umacrondieresis

1E7A



Udotbelow

1EE4

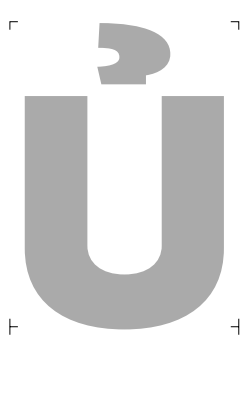

Uhookabove

1EE6



Uhornacute

1EE8

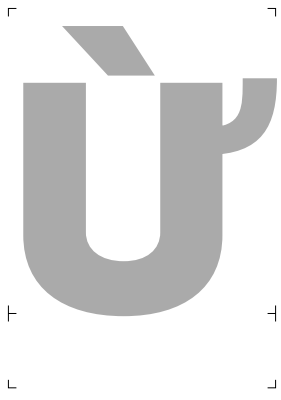

Uhorngrave

1EEA

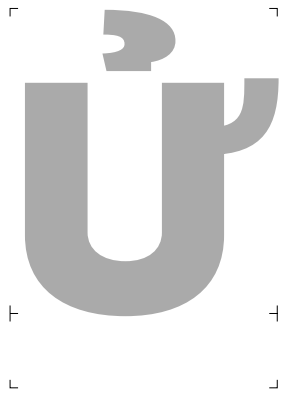

Uhornhookabove

1EEC

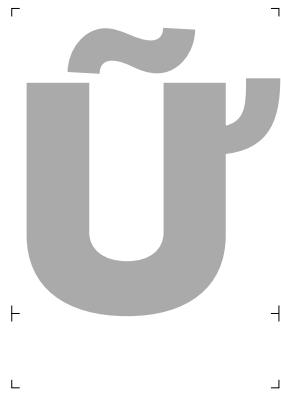

Uhorntilde

1EEE

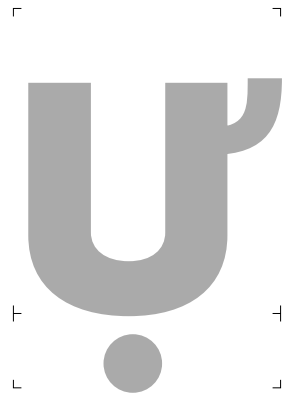

Uhorndotbelow

1EF0

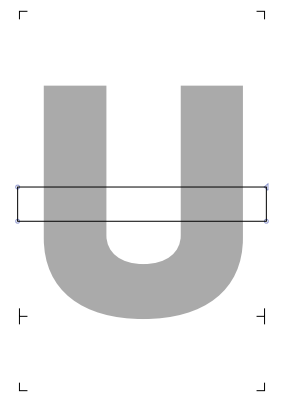

uni0244

0244

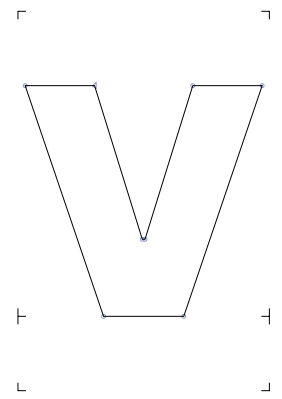

V

0056



Vtilde

1E7C

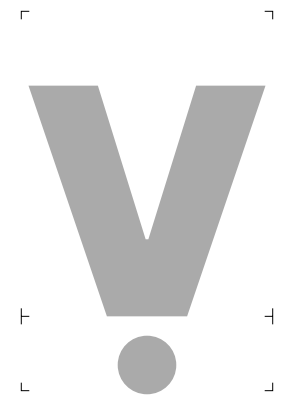

Vdotbelow

1E7E

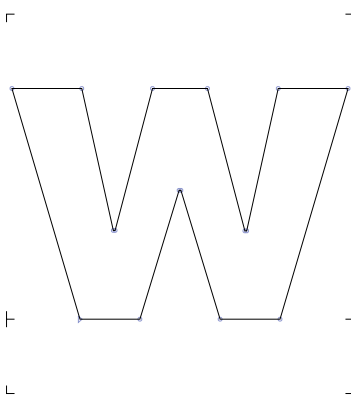

W

0057

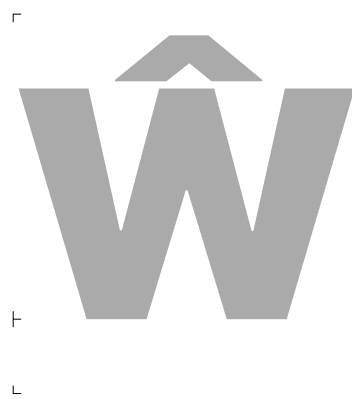

Wcircumflex

0174



Wgrave

1E80



Wacute

1E82



Wdieresis

1E84



Wdotaccent

1E86



Wdotbelow

1E88

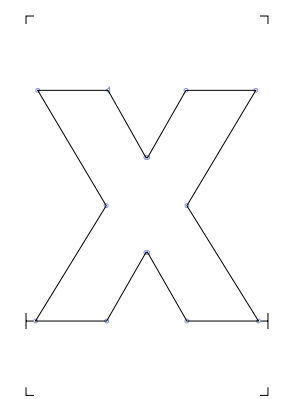

X

0058

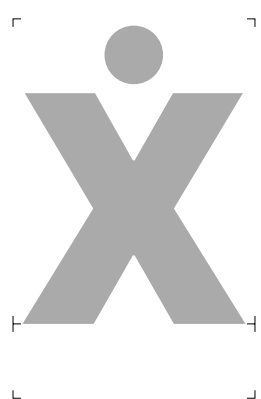

Xdotaccent

1E8A

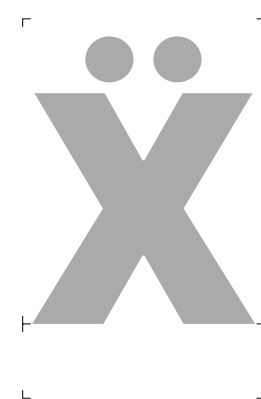

Xdieresis

1E8C

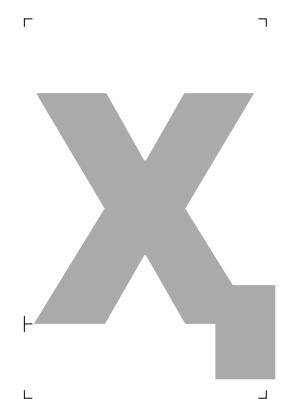

Hadescendercyrillic

04B2

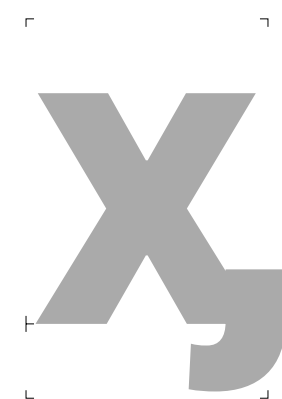

uni04FC

04FC

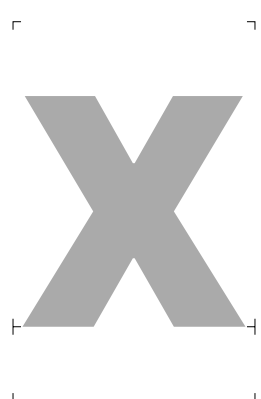

Chi

03A7

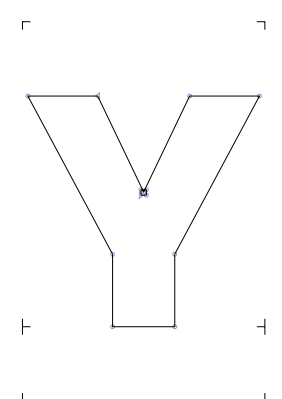

Y

0059

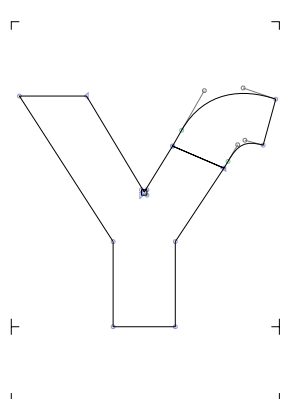

Yhook

01B3

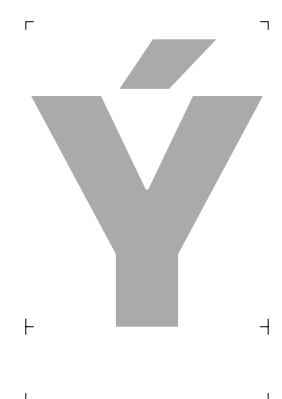

Yacute

00DD



Ycircumflex

0176



Ydieresis

0178



uni0232

0232



Ydotaccent

1E8E



Ygrave

1EF2



Ydotbelow

1EF4



Yhookabove

1EF6



Ytilde

1EF8

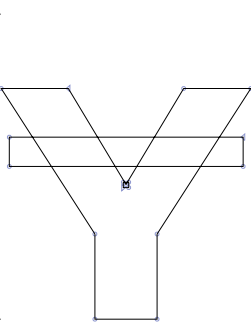

uni024E

024E



Upsilon

03A5

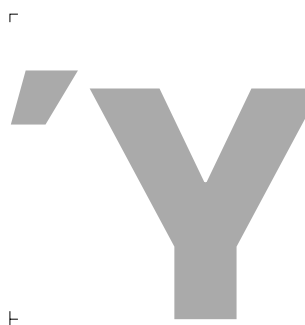

Upsilontonos

038E



Upsilondieresis

03AB

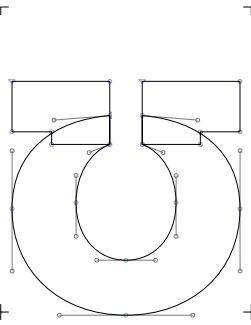

Upsilon2

01B1

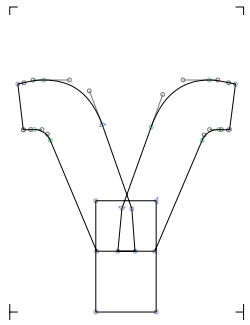

Upsilonhooksymbol

03D2

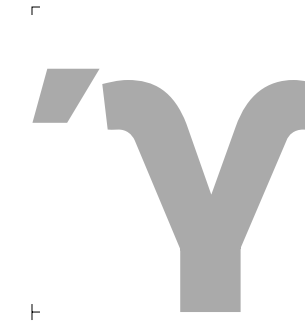

Upsilonacutehooksymbolgreek

03D3



Upsilondieresishooksymbolgreek

03D4

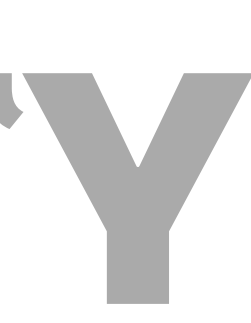

uni1F59

1F59



uni1F5B

1F5B



uni1F5D

1F5D

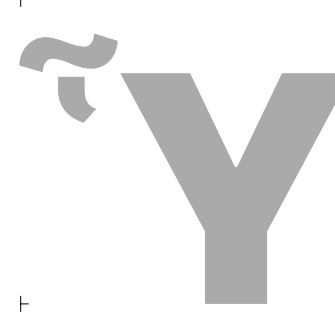

uni1F5F

1F5F



uni1FE8

1FE8

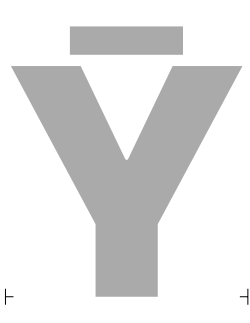

uni1FE9

1FE9

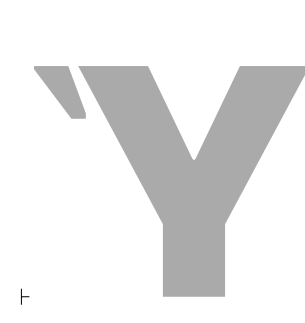

uni1FEA

1FEA

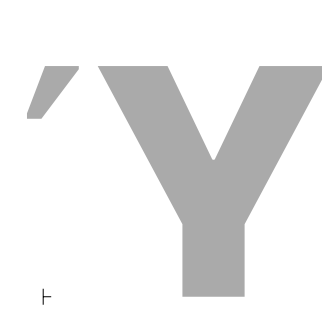

uni1FEB

1FEB

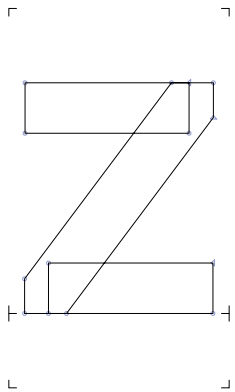

Z

005A

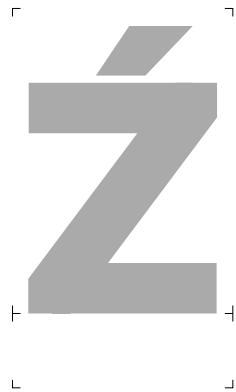

Zacute

0179



Zdotaccent

017B

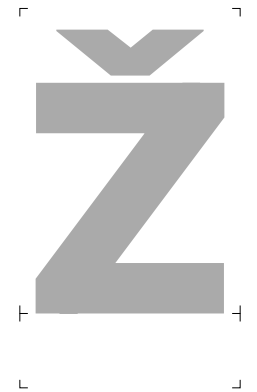

Zcaron

017D

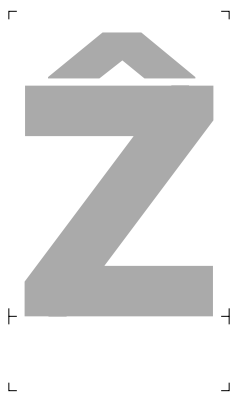

Zcircumflex

1E90

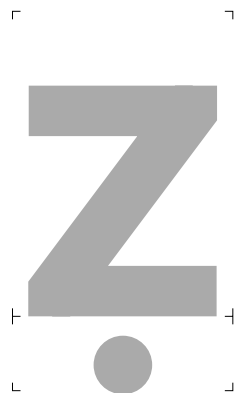

Zdotbelow

1E92



Zlinebelow

1E94

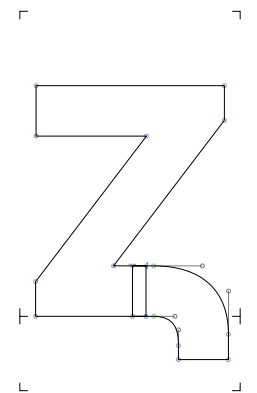

uni0224

0224



Zbar

01B5



Zeta

0396

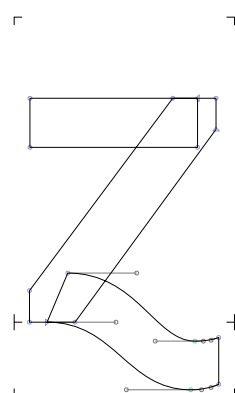

uni2C7F

2C7F

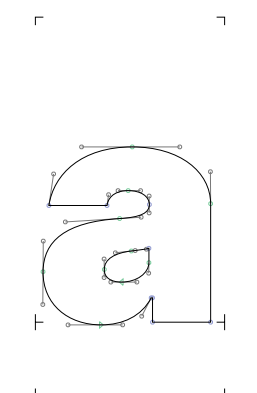

a

0061



adieresis

00E4



atilde

00E3



aringhalfring

1E9A

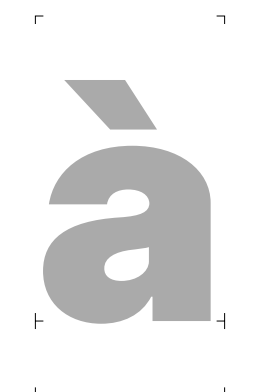

agrave

00E0



acute

00E1



acircumflex

00E2



aring

00E5



amacron

0101



abreve

0103



aogonek

0105



acaron

01CE



adieresismacron

01DF



adotmacron 01E1



aringacute 01FB



adblgrave 0201



ainvertedbreve 0203



uni0227 0227



aringbelow 1E01



adotbelow 1EA1



ahookabove 1EA3



acircumflexacute 1EA5



acircumflexgrave 1EA7

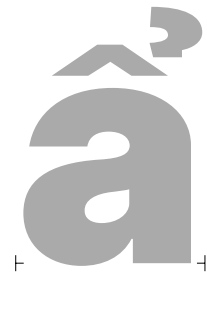

acircumflexhookabove 1EA9



acircumflextilde 1EAB



acircumflexdotbelow 1EAD



abreveacute 1EAF

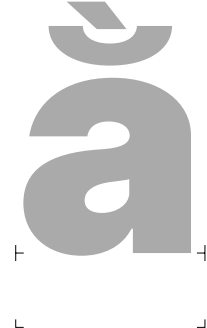

abrevegrave 1EB1



abrevehookabove 1EB3



abrevetilde 1EB5



abrevedotbelow 1EB7

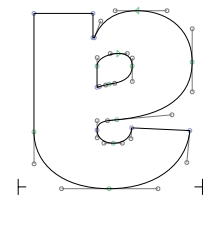

aturn 0250



afi10065 0430



abrevycyrillic 04D1





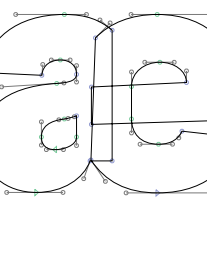





adieresisyrillic 04D3

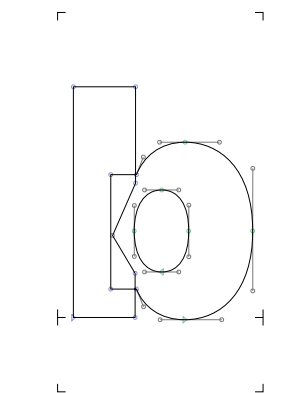

ae 00E6

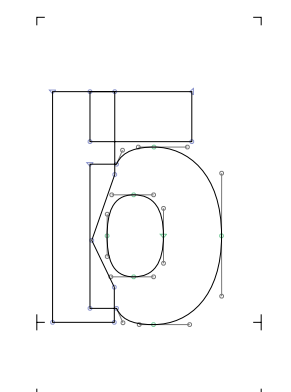
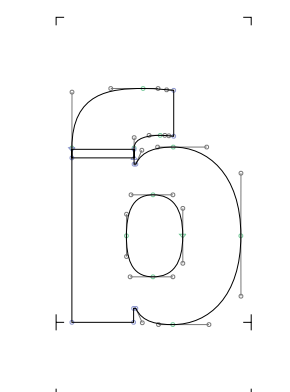
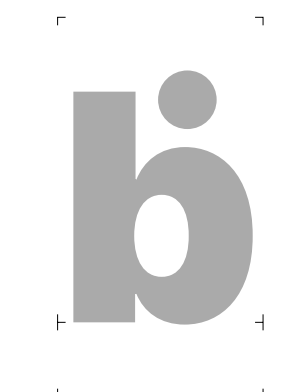
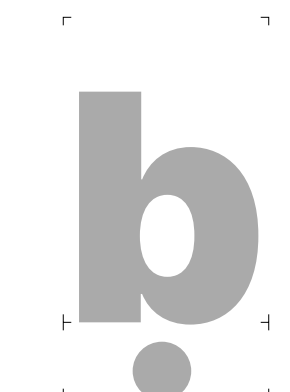
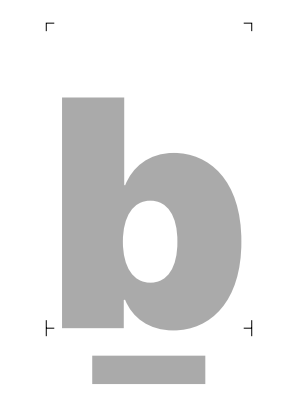
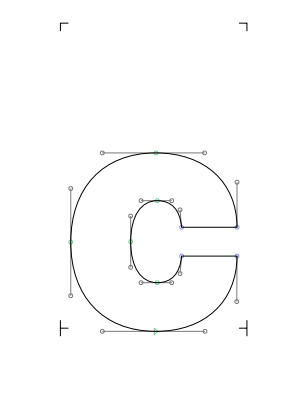
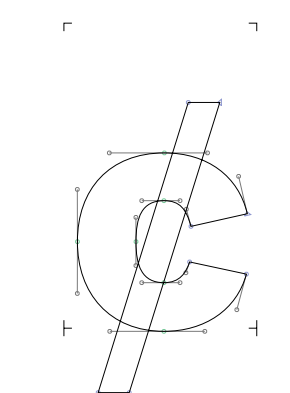
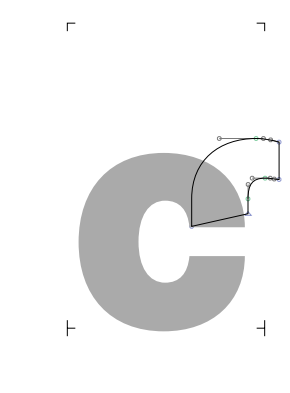
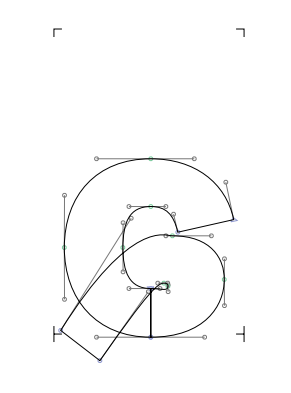
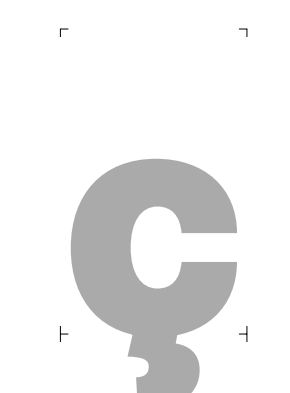
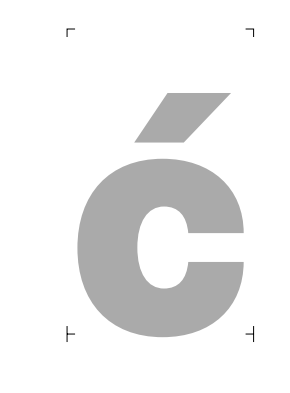
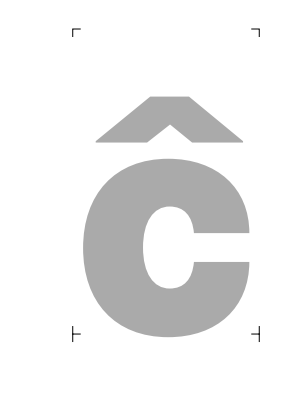
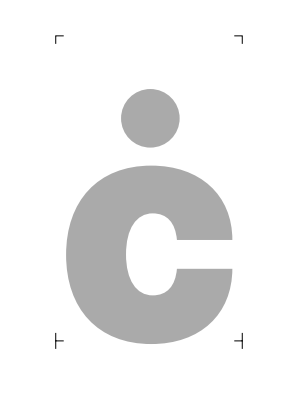
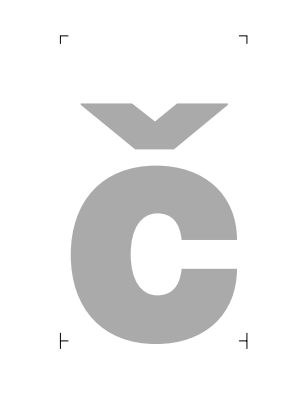
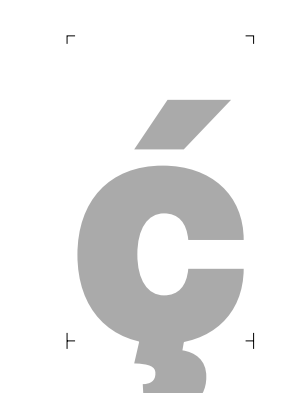
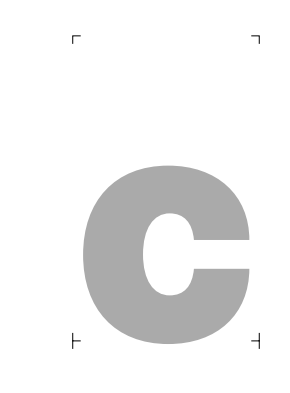

aemacron 01E3

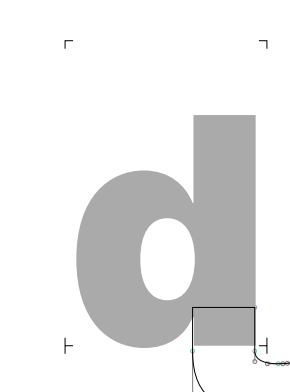
			
aeacute 01FD	aiecyrillic 04D5	b 0062	bbar 0180
			
btopbar 0183	bhook 0253	bdotaccent 1E03	bdotbelow 1E05
			
blinebelow 1E07	c 0063	uni023C 023C	chook 0188
			
ccurl 0255	ccedilla 00E7	cacute 0107	ccircumflex 0109
			
cdotaccent 010B	ccaron 010D	ccedillaacute 1E09	sigmalunatesymbolgreek 03F2
			
escyrillic 0441	d 0064	dcroat 0111	drthook 0256

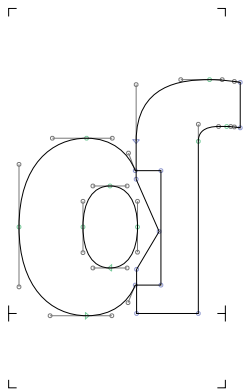

dhook 0257

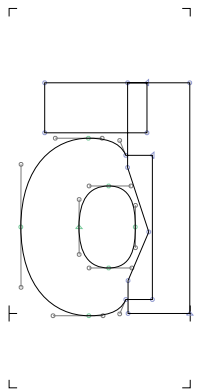

dtopbar 018C

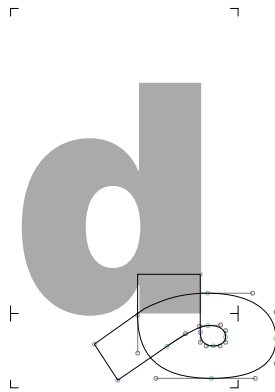

uni0221 0221



dcaron 010F



ddotaccent 1E0B



ddotbelow 1E0D



dlinebelow 1E0F



dcedilla 1E11



dcircumflexbelow 1E13



dz 02A3



dzcaron 01C6



dzcurl 02A5

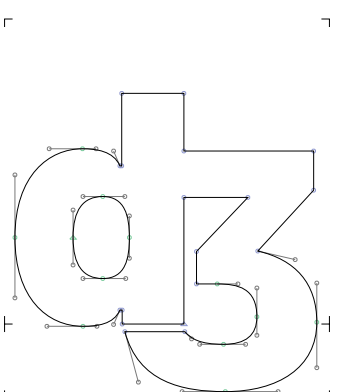

dyogh 02A4



dong 20AB

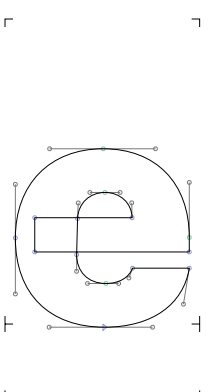

e 0065

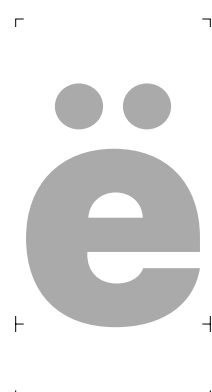

edieresis 00EB

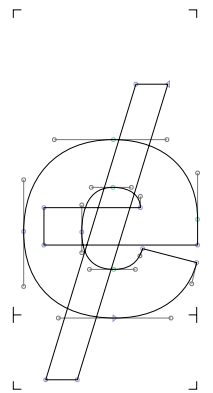

uni0247 0247



egrave 00E8



eacute 00E9



ecircumflex 00EA



emacron 0113



ebreve 0115



edotaccent 0117



eogonek 0119



ecaron

011B



edblgrave

0205



einvertedbreve

0207



uni0229

0229



emacrongrave

1E15



emacronacute

1E17



ecircumflexbelow

1E19



etildebelow

1E1B



ecedillabreve

1E1D



edotbelow

1E89

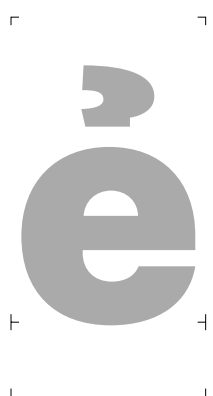

ehookabove

1EBB



etilde

1EBD



ecircumflexacute

1EBF



ecircumflexgrave

1EC1



ecircumflexhookabove

1EC3



ecircumflextilde

1EC5

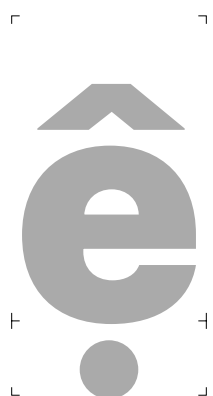

ecircumflexdotbelow

1EC7



iecyrillic

0435



uni0450

0450



iocyrillic

0451



iebrevecyrillic

04D7



eturn

01DD

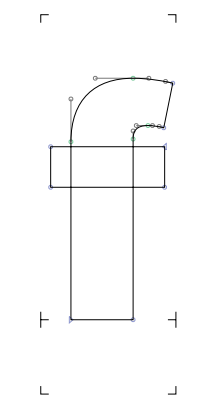

f

0066

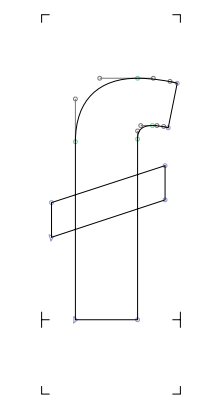

slongstroke

1E9C

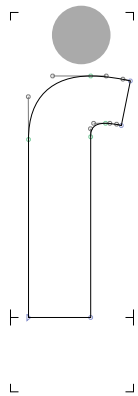

slongdotaccent

1E9B



fdotaccent

1E1F



feng

02A9

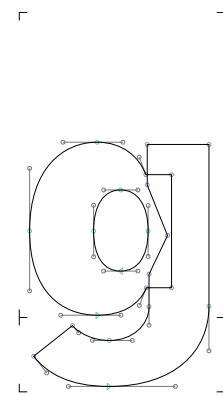

g

0067

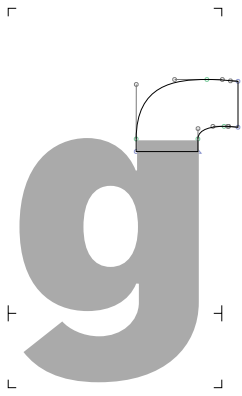

ghook

0260



gbar

01E5

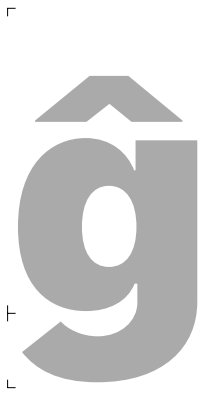

gcircumflex

011D



gbreve

011F



gdotaccent

0121



gcommaaccent

0123



gcaron

01E7



gacute

01F5



gmacron

1E21

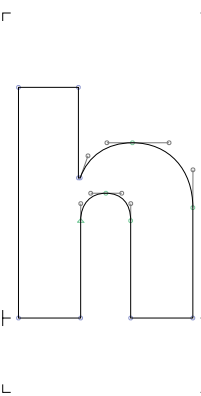

h

0068



hcedilla

1E29



tshecyrillic

045B

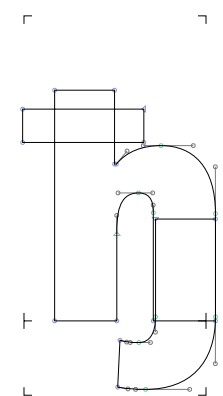

djecyrillic

0452

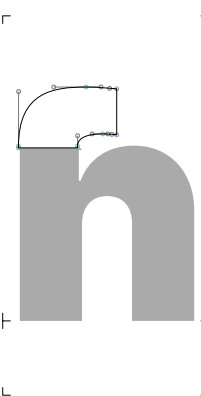

hhook

0266



henghook

0267

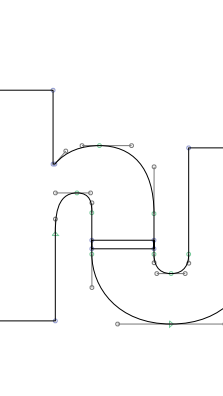

hv

0195



hturn

0265

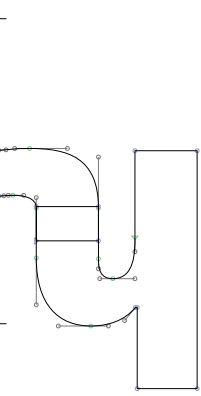

hturnlthook

02AE

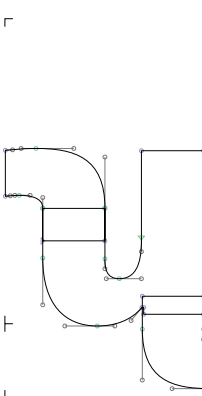

hturnhook2

02AF



hbar

0127

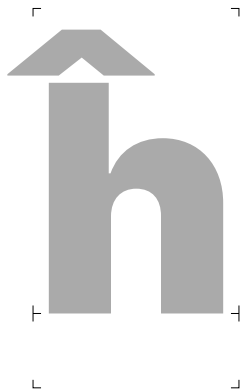

hcircumflex

0125

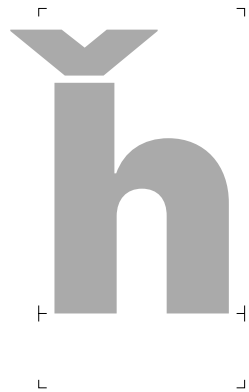

uni021F

021F

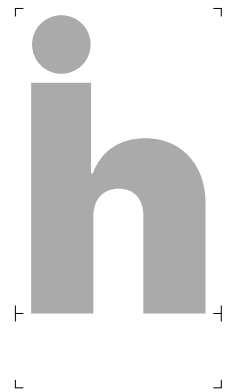

hdotaccent

1E23

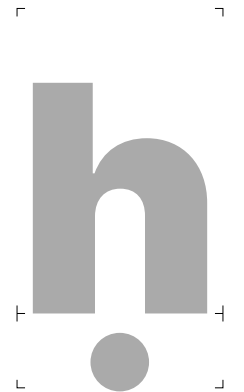

hdotbelow

1E25



hdieresis

1E27



hbrevebelow

1E2B

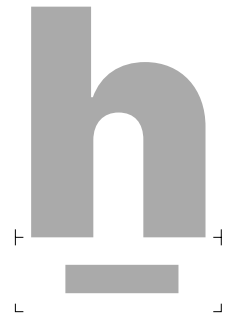

hlinebelow

1E96

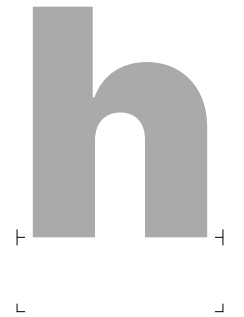

shhacyrillic

04BB



i

0069

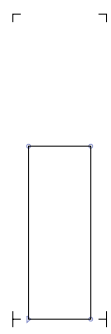

idotless

0131



idieresis

00EF

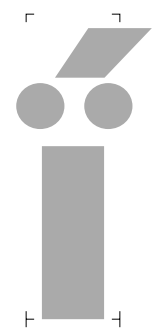

idieresisacute

1E2F



itilde

0129



itildebelow

1E2D

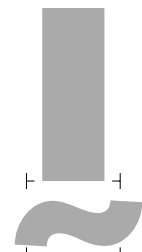

uni1E2D.ccmp



ibar

0268



igrave

00EC



iacute

00ED



icircumflex

00EE



imacron

012B



ibreve

012D



uni012F.ccmp



iogonek

012F



icaron

01D0



idblgrave

0209



iinvertedbreve

020B



ihookabove

1EC9



idotbelow

1ECB



uni1ECB.ccmp

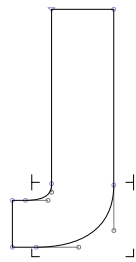

jdotless

0237

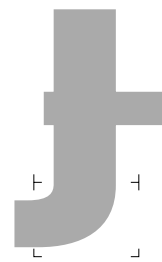

jdotlessbar

025F



uni0249

0249

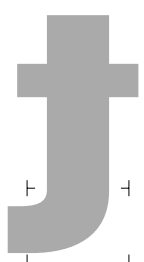

uni0249.ccmp



icyrillic

0456

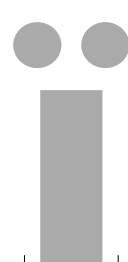

iy Cyrillic

0457

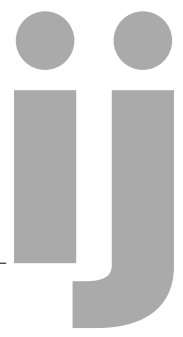

ij

0133



j

006A

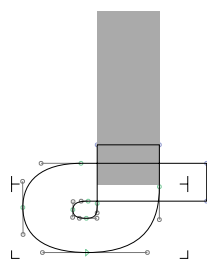

jcrosstail.ccmp

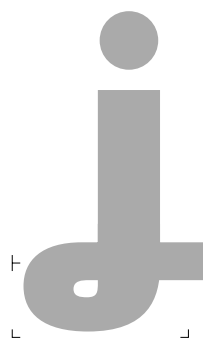

jcrosstail

029D

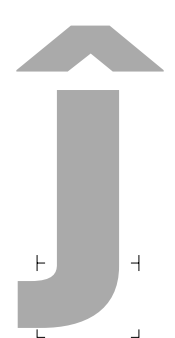

jcircumflex

0135



jcaron

01F0



yotgreek

03F3



jecyrillic

0458

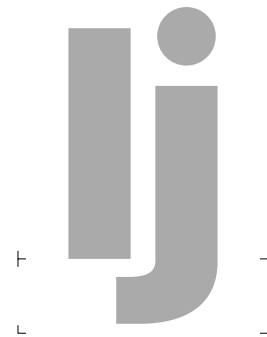

lj

01C9

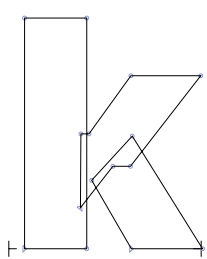

k

006B

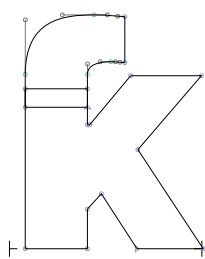

khook

0199



kcommaaccent

0137

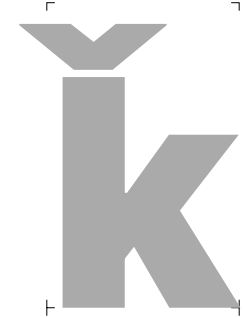

kcaron

01E9



kacute

1E31



kdotbelow

1E33



klinebelow

1E35

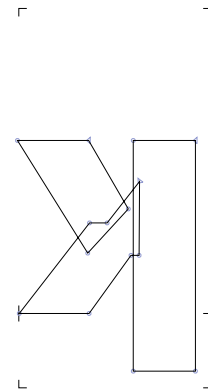

kturn

029E

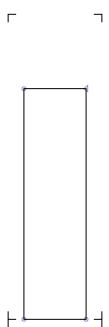

l

006C

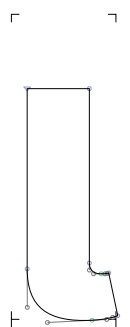

l.ss02

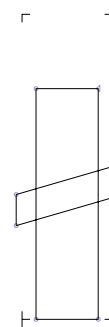

lslash

0142

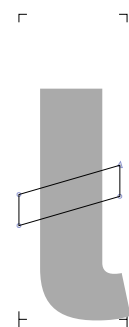

lslash.ss02

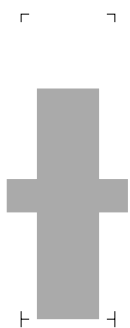

lbar

019A



lbar.ss02



lmidtilde

026B



lmidtilde.ss02

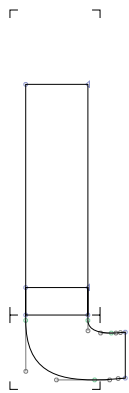

lrhook

026D

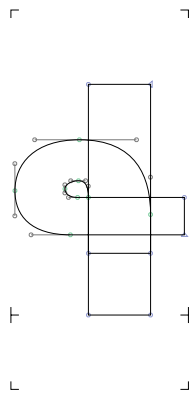

lbelt

026C

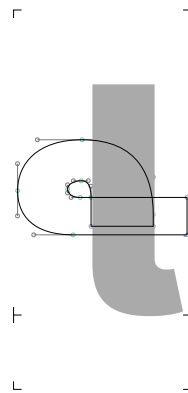

lbelt.ss02

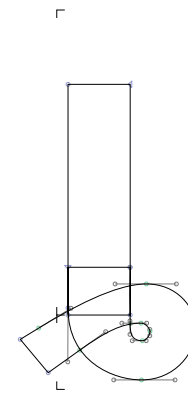

lcurl

0234



ldot

0140



ldot.ss02



lacute

013A



lacute.ss02



lcommaaccent

013C



lcommaaccent.ss02



lcaron

013E



lcaron.ss02



ldotbelow

1E37



ldotbelow.ss02



ldotbelowmacron

1E39



ldotbelowmacron.ss02



llinebelow

1E3B



llinebelow.ss02



lcircumflexbelow

1E3D



lcircumflexbelow.ss02



uni04CF

04CF

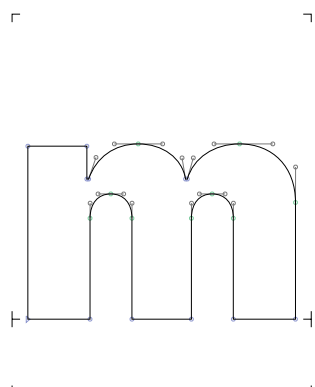

m

006D

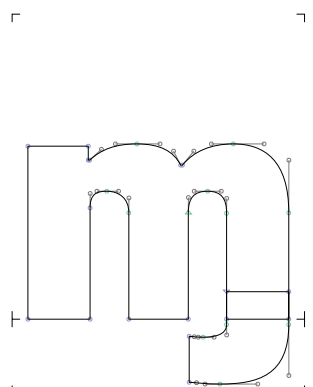

mhook

0271



mturn

026F

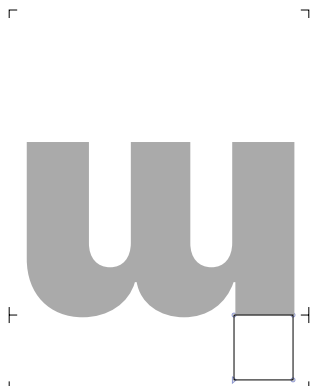

mturndescend

0270



macute

1E3F



mdotaccent

1E41



mdotbelow

1E43

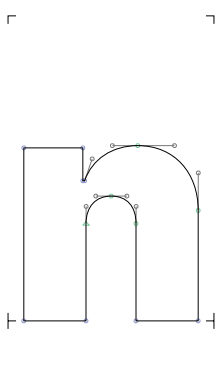

n

006E

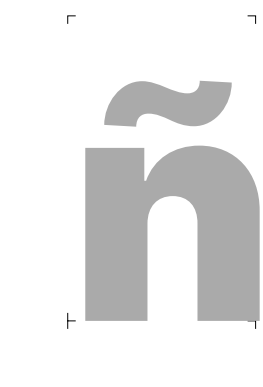

ntilde

00F1

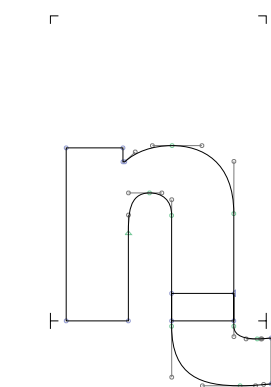

nrthook

0273

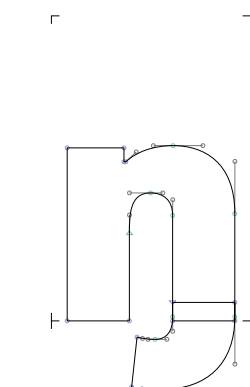

eng

014B

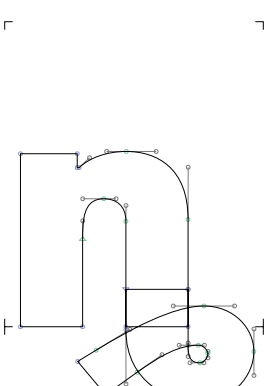

ncurl

0235

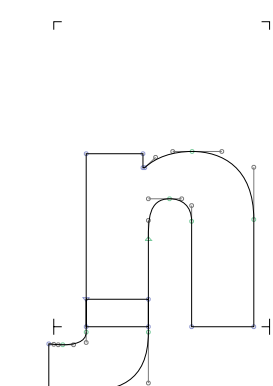

nlfthook

0272



nletrightlong

019E



nacute

0144

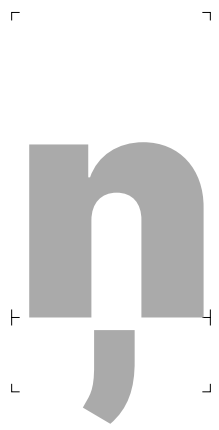

ncommaaccent 0146



ncaron 0148



uni01F9 01F9



ndotaccent 1E45



ndotbelow 1E47



nlinebelow 1E49



ncircumflexbelow 1E4B



nj 01CC

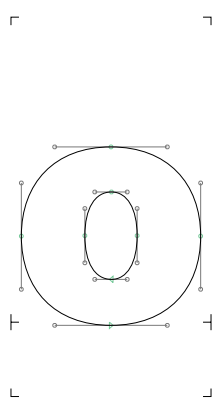

o 006F

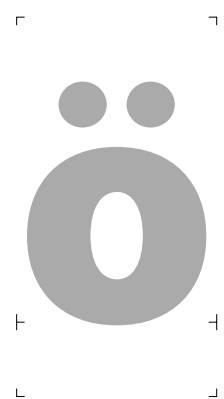

odieresis 00F6



otilde 00F5

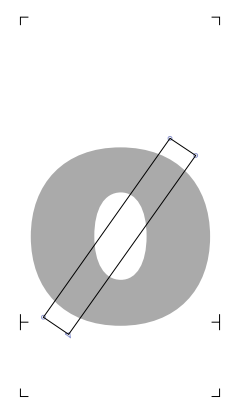

oslash 00F8

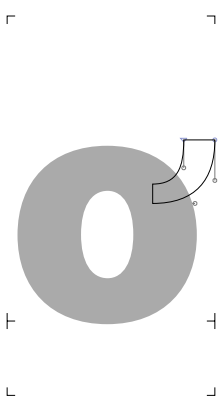

ohorn 01A1

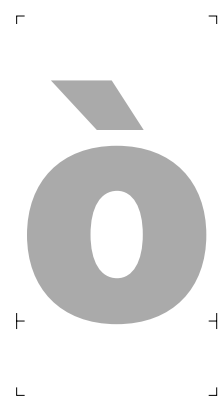

ograve 00F2



oacute 00F3

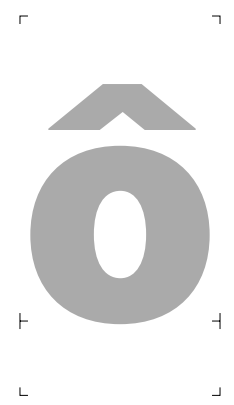

ocircumflex 00F4

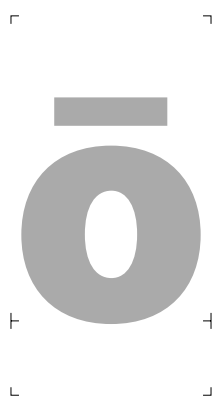

omacron 014D

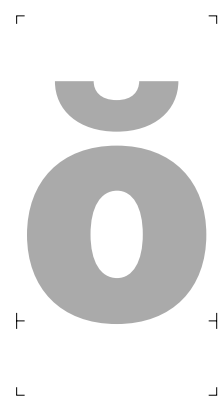

obreve 014F



ohungarumlaut 0151

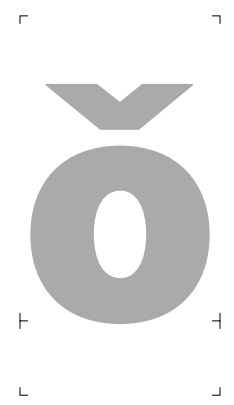

ocaron 01D2

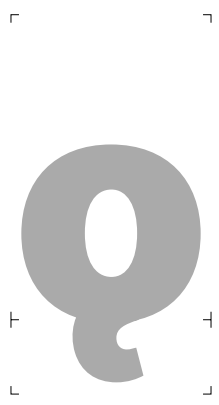

oogonek 01EB

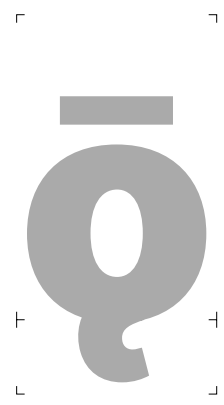

oogonekmacron 01ED



odblgrave 020D

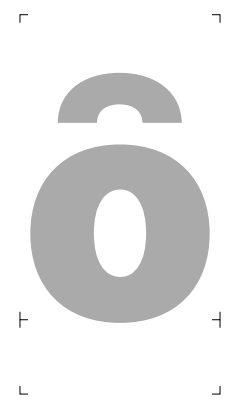

oinvertedbreve 020F

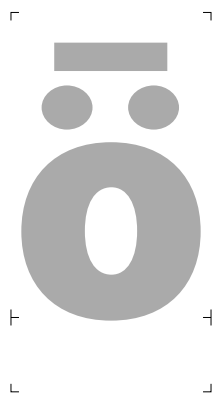

uni022B

022B



uni022D

022D

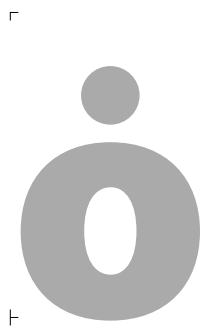

uni022F

022F



uni0231

0231



otildeacute

1E4D



otildedieresis

1E4F



omacrongrave

1E51



omacronacute

1E53

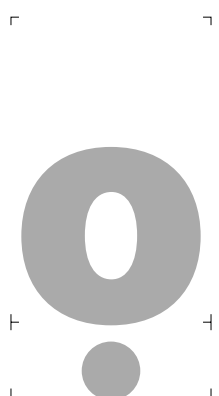

odotbelow

1ECD

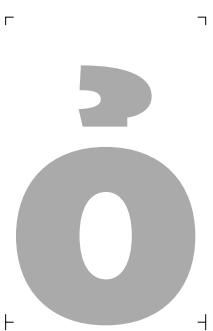

ohookabove

1ECF



ocircumflexacute

1ED1

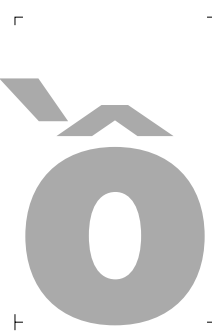

ocircumflexgrave

1ED3

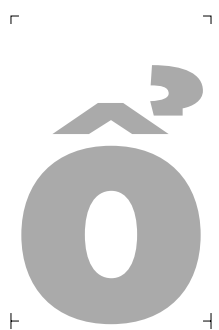

ocircumflexhookabove

1ED5



ocircumflextilde

1ED7



ocircumflexdotbelow

1ED9



ohornacute

1EDB

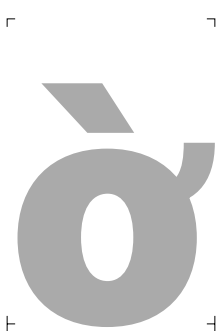

ohorngrave

1EDD



ohornhookabove

1EDF



ohorntilde

1EE1



ohorndotbelow

1EE3

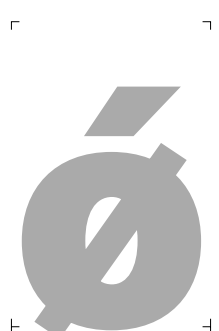

oslashacute

01FF

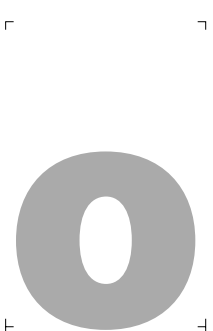

omicron

03BF



omicrontonos

03CC

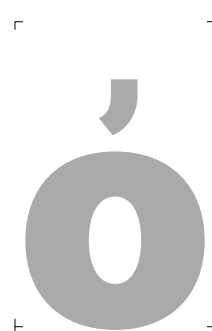

uni1F40

1F40

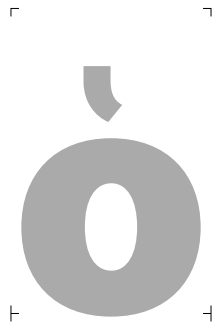

uni1F41

1F41

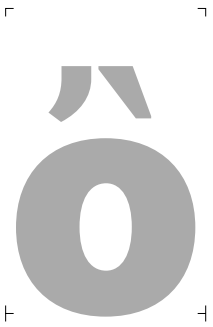

uni1F42

1F42



uni1F43

1F43



uni1F44

1F44



uni1F45

1F45

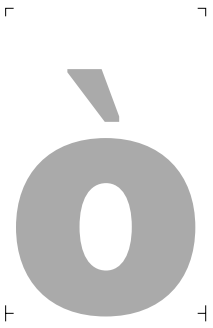

uni1F78

1F78

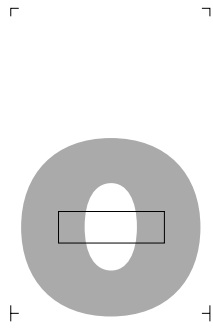

fitacyrillic

0473



obar

0275

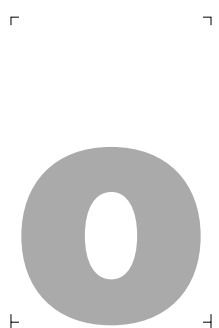

ocyrillic

043E

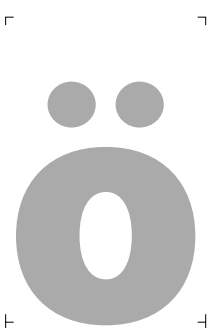

odieresiscyrillic

04E7



oe

0153



ukcyrillic

0479

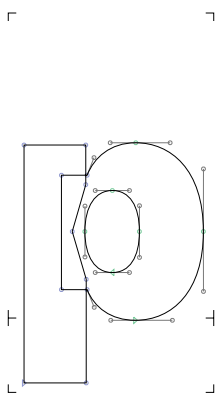

p

0070

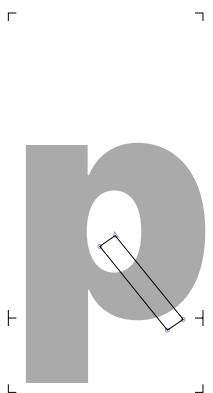

uni048F

048F

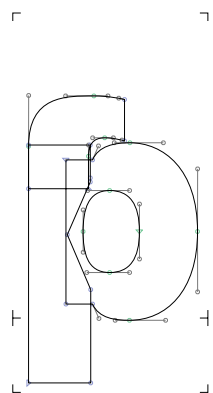

phook

01A5



pacute

1E55



pdotaccent

1E57



ercyrillic

0440



q

0071

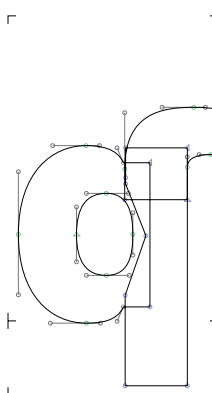

qhook

02A0

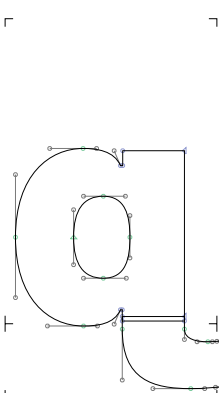

qrhook

024B

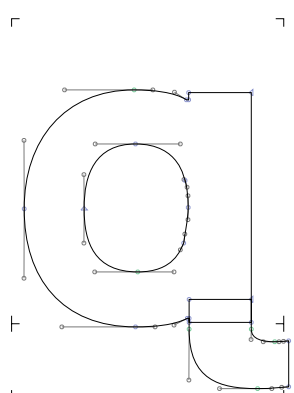

Q_rhook

024A

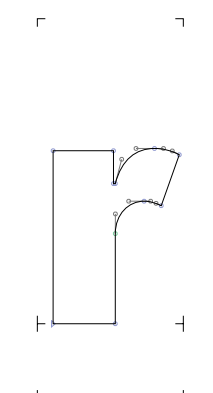

r

0072



rrhook

027D



uni024D

024D

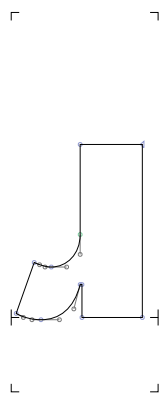

rturn

0279



rturnrthook

027B

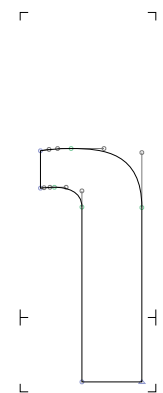

rfishhookrev

027F

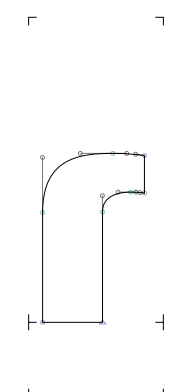

rfishhook

027E



rdescend

027C



racute

0155



rcommaaccent

0157



rcaron

0159



rdblgrave

0211



rinvertedbreve

0213



rdotaccent

1E59



rdotbelow

1E5B



rdotbelowmacron

1E5D



rlinebelow

1E5F

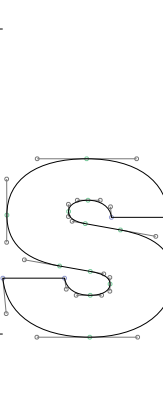

s

0073

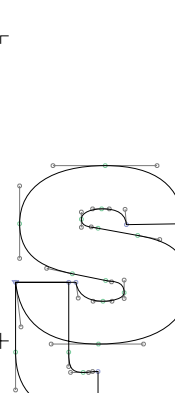

srthook

0282



uni023F

023F



sacute

015B



scircumflex

015D



scedilla

015F



scaron

0161



scommaaccent

0219



sdotaccent

1E61



sdotbelow

1E63



sacutedotaccent

1E65



scarondotaccent

1E67



sdotbelowdotaccent

1E69



dzecyrillic

0455



tonetwo

01A8

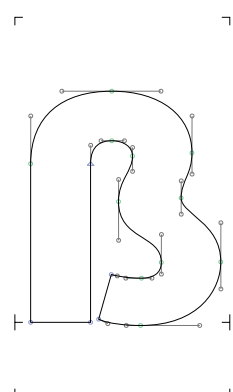

germandbls

00DF

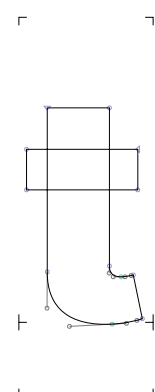

t

0074

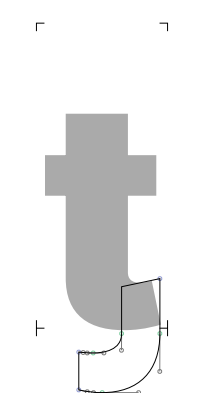

tpalatalhook

01AB

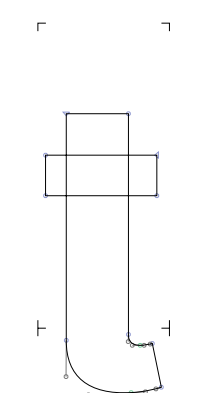

trthook

0288

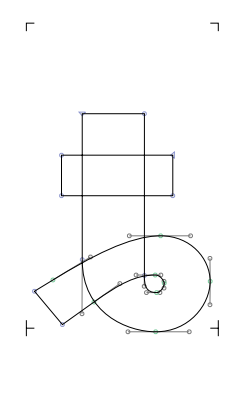

tcurl

0236

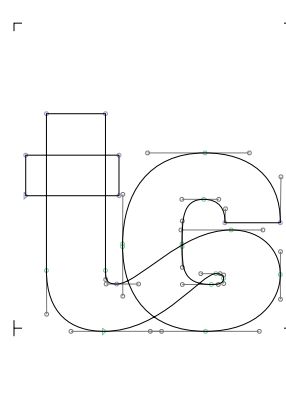

tcurl

02A8



tturn

0287

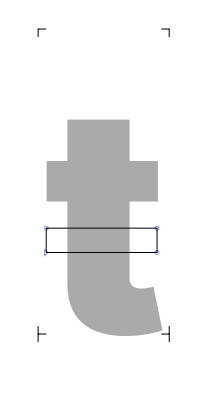

tbar

0167



tcommaaccent

0163

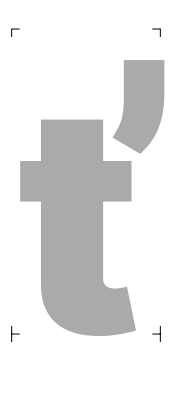

tcaron

0165

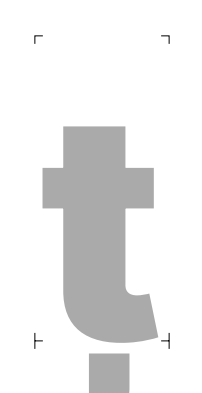

uni021B

021B

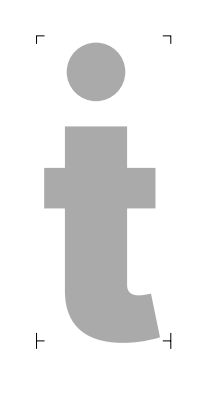

tdotaccent

1E6B

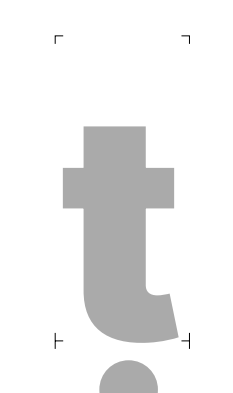

tdotbelow

1E6D



tlinebelow

1E6F



tcircumflexbelow

1E71

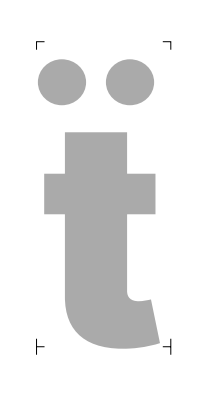

tdieresis

1E97

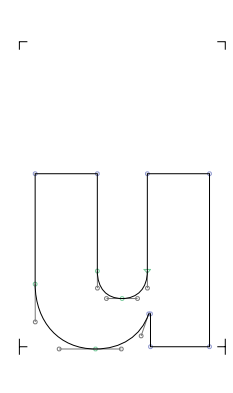

u

0075



udieresis

00FC



utilde

0169

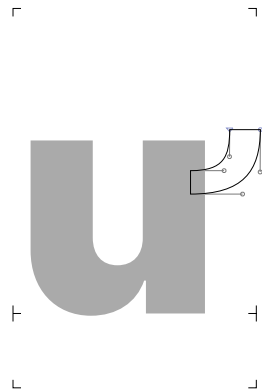

uhorn

0180

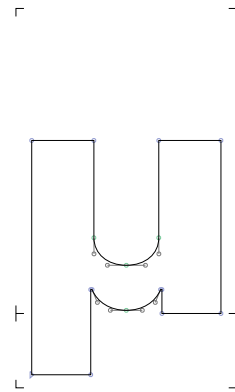

micro

00B5

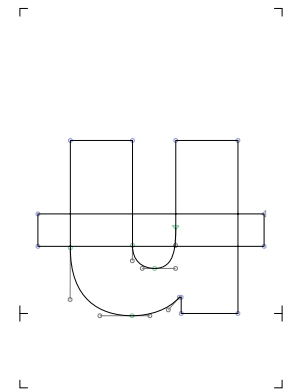

ubar

0289



ugrave

00F9

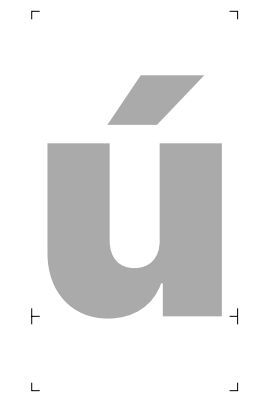

uacute

00FA

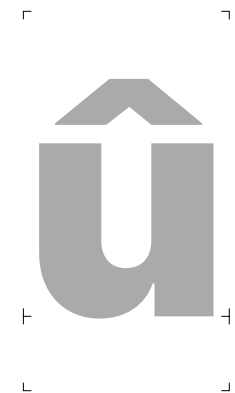

ucircumflex

00FB



umacron

016B



ubreve

016D

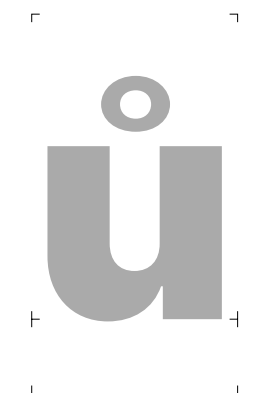

uring

016F



uhungarumlaut

0171

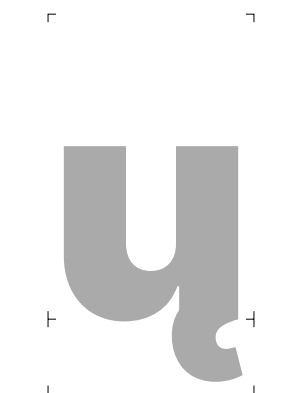

uogonek

0173



ucaron

01D4

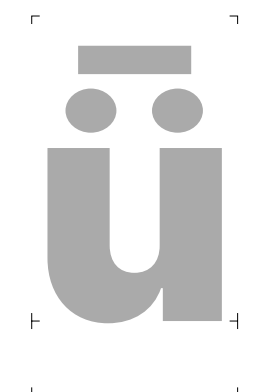

udieresismacron

01D6



udieresisacute

01D8

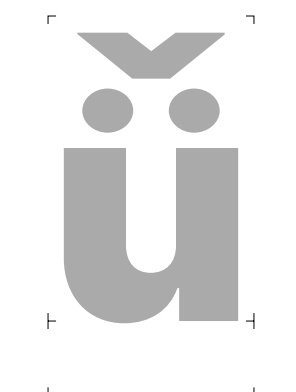

udieresiscaron

01DA



udieresisgrave

01DC

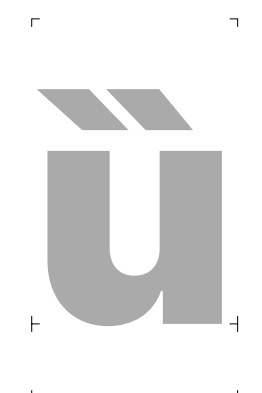

udblgrave

0215



uinvetredbreve

0217

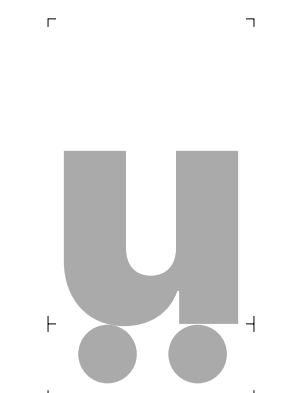

udieresisbelow

1E73



utildebelow

1E75



ucircumflexbelow

1E77



utildeacute

1E79

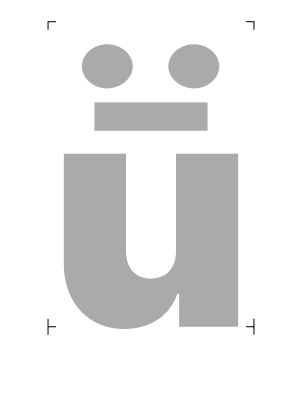

umacrondiereis

1E7B



udotbelow 1EE5



uhookabove 1EE7

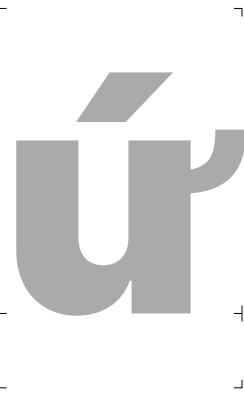

uhornacute 1EE9

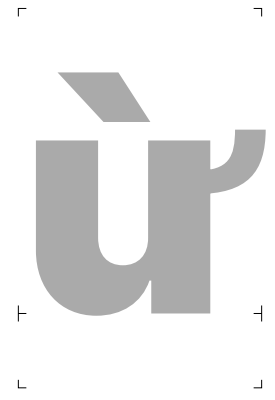

uhorngrave 1EEB

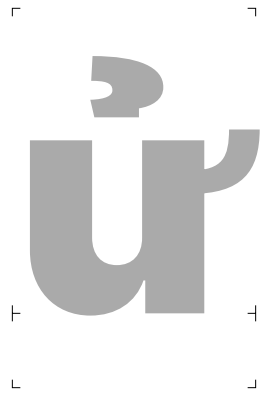

uhornhookabove 1EED



uhorntilde 1EEF



uhorndotbelow 1EF1

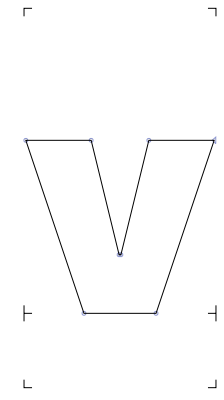

v 0076



vturn 028C



vtilde 1E7D

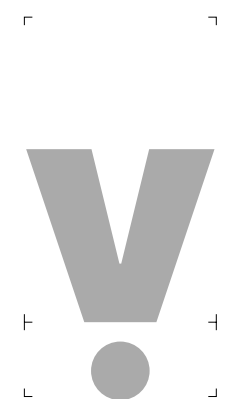

vdotbelow 1E7F

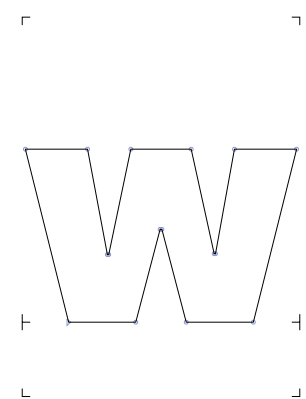

w 0077



wdieresis 1E85

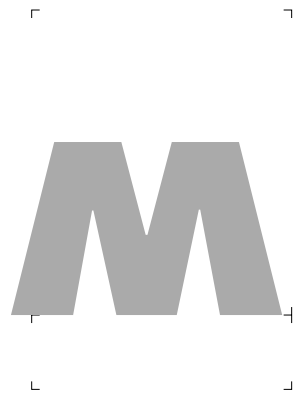

wturn 028D

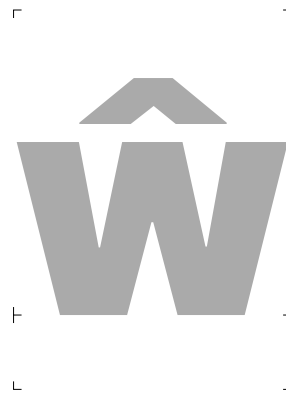

wcircumflex 0175



wgrave 1E81



wacute 1E83



wdotaccent 1E87



wdotbelow 1E89



wring 1E98

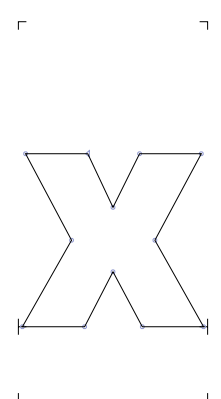

x 0078



xdotaccent 1E8B



xdieresis 1E8D



khacyrillic 0445

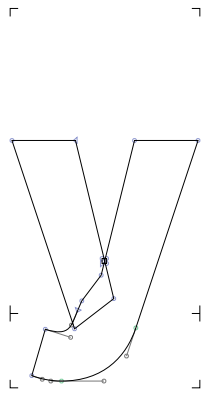

y

0079



ydieresis

00FF

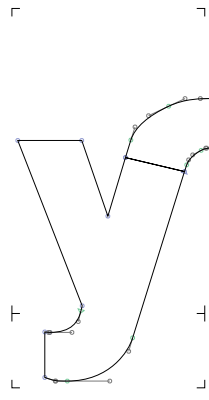

yhook

01B4

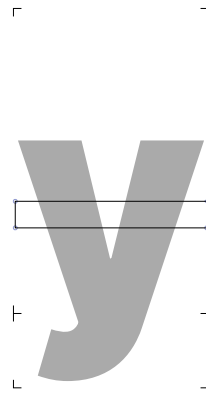

uni024F

024F



yacute

00FD

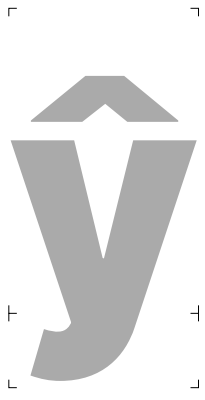

ycircumflex

0177



uni0233

0233



ydotaccent

1E8F

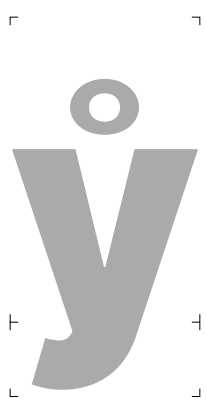

yring

1E99



ygrave

1EF3



ydotb

1EF5



yhookabove

1EF7



ytilde

1EF9



ucyrillic

0443



ushortcyrillic

045E



umacroncyrillic

04EF



udieresiscyrillic

04F1



uhungarumlautcyrillic

04F3

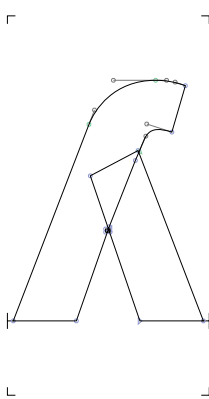

yturn

028E

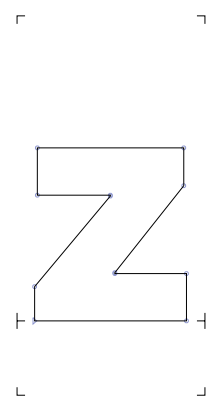

z

007A



zbar

01B6

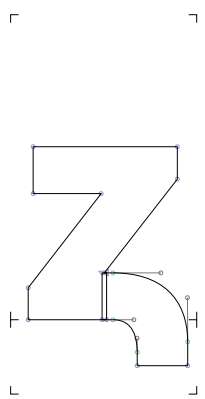

zhook

0225

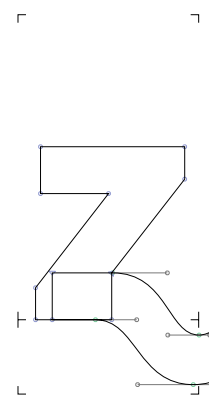

uni0240

0240

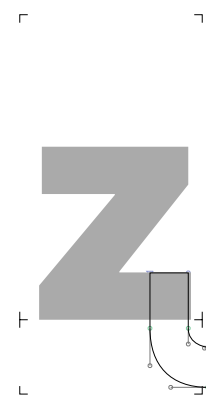

zrhook

0290



zacute 017A



zdotaccent 017C



zcaron 017E



zcircumflex 1E91



zdotbelow 1E93



zlinebelow 1E95

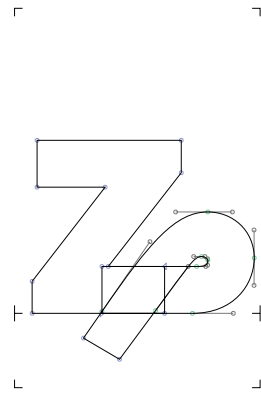

zcurl 0291

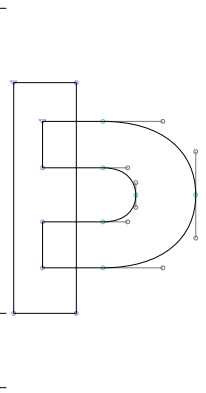

Thorn 00DE

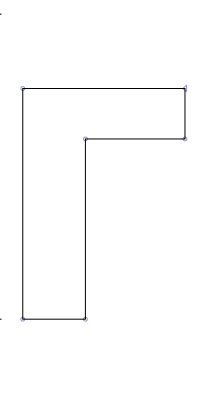

Gamma 0393

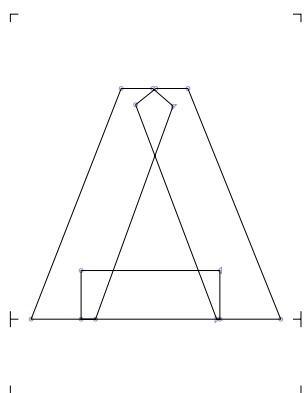

Delta 0394

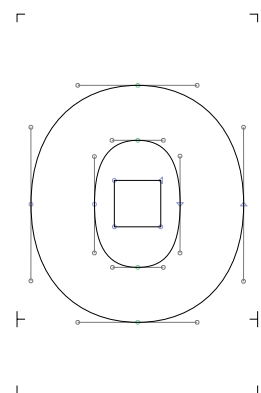

Theta 0398

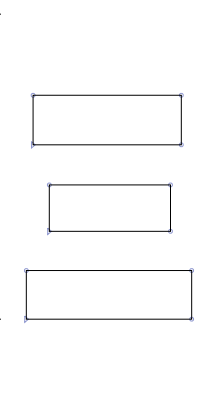

Xi 039E

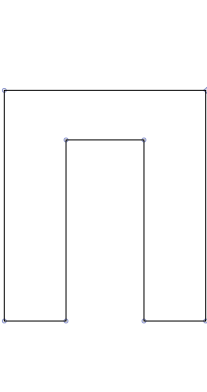

Pi 03A0

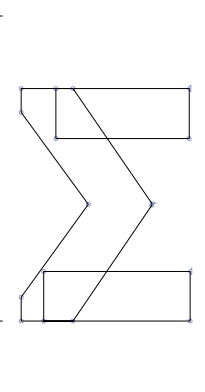

Sigma 03A3

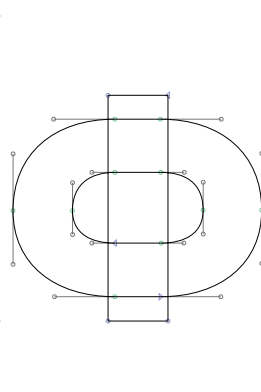

Phi 03A6

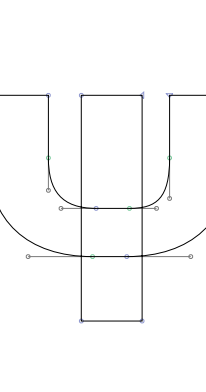

Psi 03A8

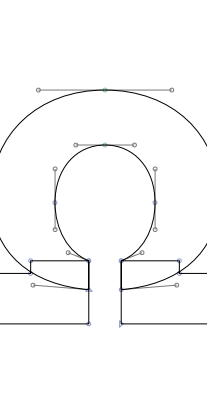

Omega 03A9



uni1FFB 1FFB



Omegatonos 038F



uni1F68 1F68



uni1F69 1F69

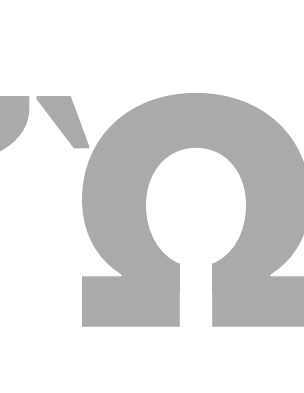

uni1F6A 1F6A

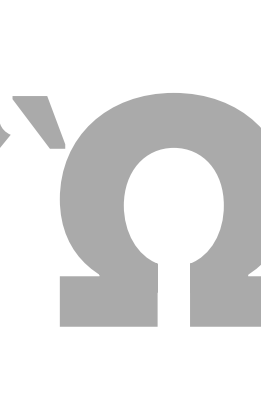

uni1F6B 1F6B



uni1F6C 1F6C

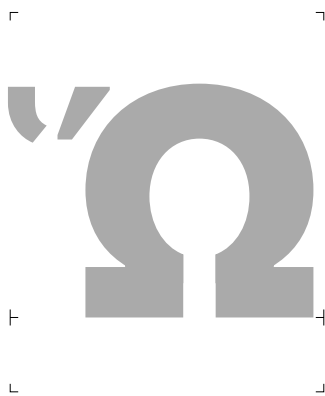

uni1F6D 1F6D



uni1F6E 1F6E

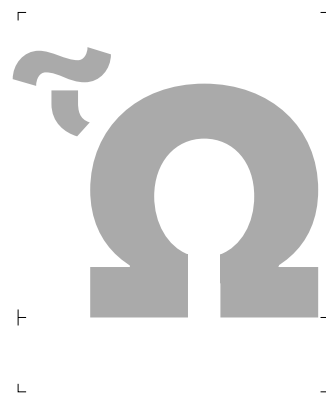

uni1F6F 1F6F

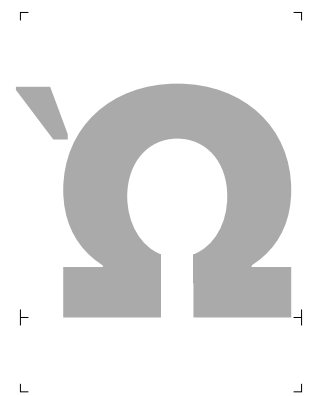

uni1FFA 1FFA

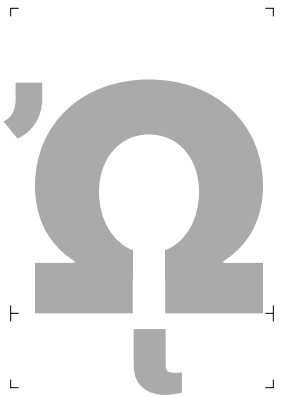

uni1FA8 1FA8

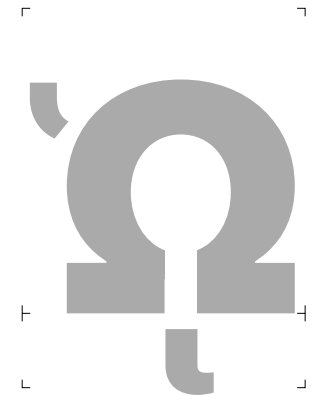

uni1FA9 1FA9

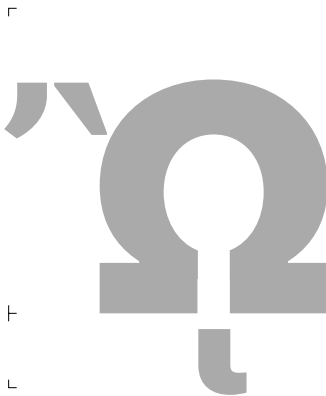

uni1FAA 1FAA

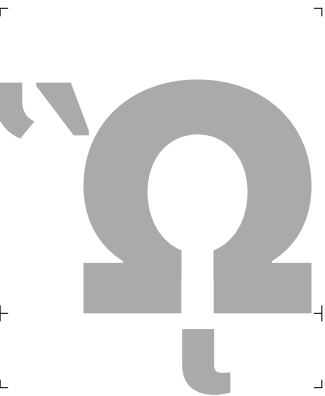

uni1FAB 1FAB

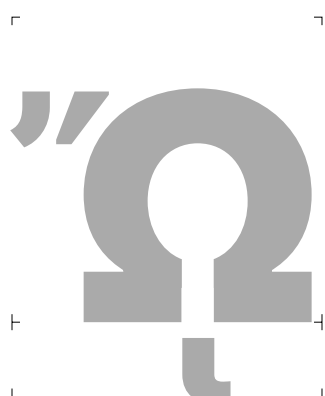

uni1FAC 1FAC

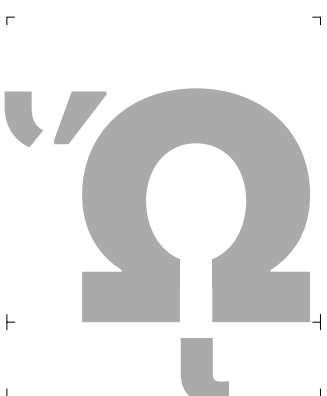

uni1FAD 1FAD

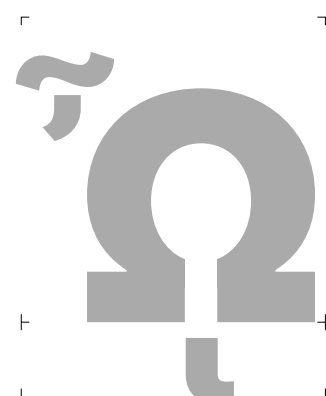

uni1FAE 1FAE

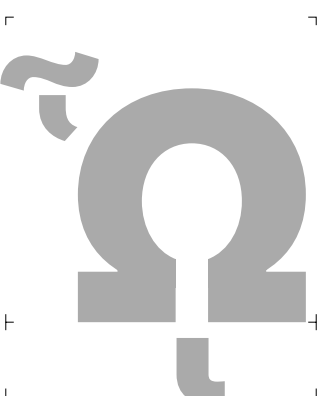

uni1FAF 1FAF

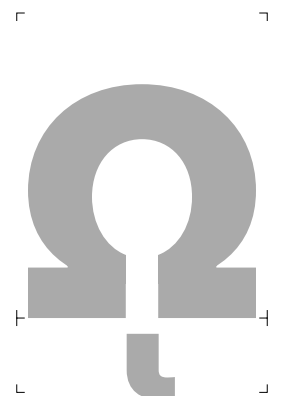

uni1FFC 1FFC

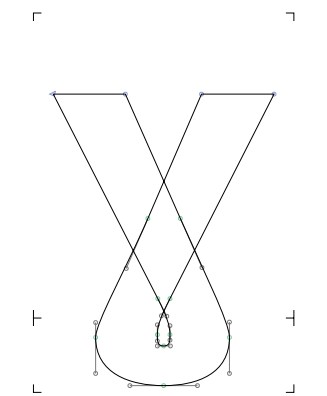

Gamma1 0194



afii10018 0411

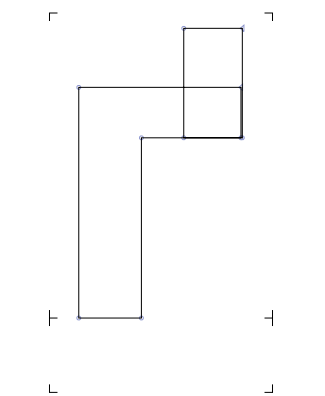

afii10050 0490

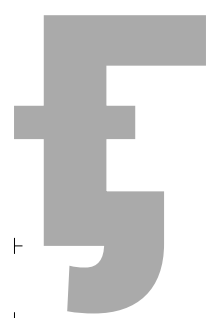

uni04FA 04FA

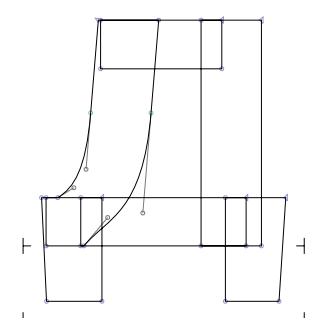

afii10021 0414

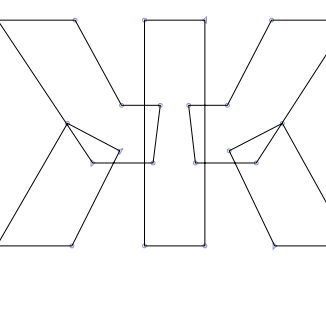

afii10024 0416



Zhedescendercyrillic 0496

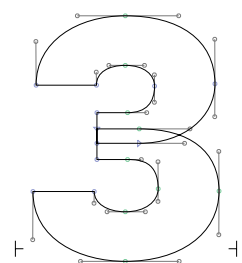

afii10025 0417

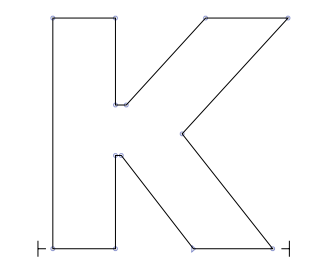

Kacyr 041A

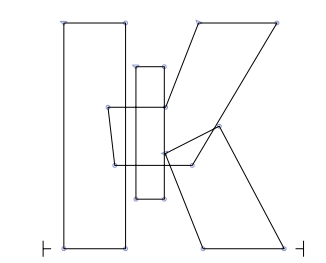

Kaverticalstrokecyrillic 049C

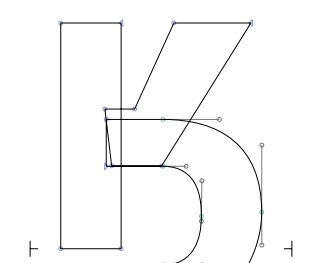

Kahookcyrillic 04C3

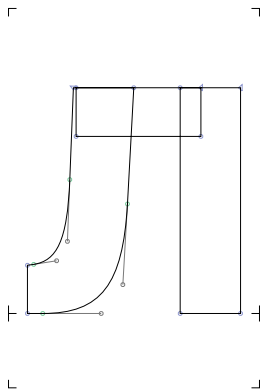

afii10029

041B

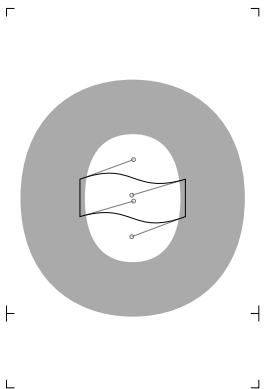

afii10147

0472

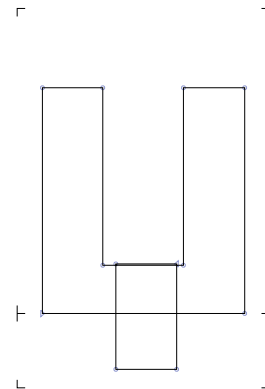

afii10145

040F

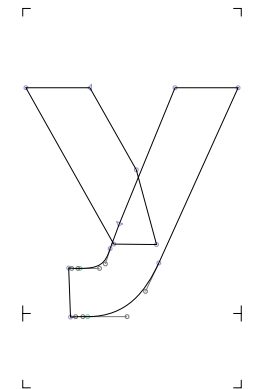

afii10037

0423

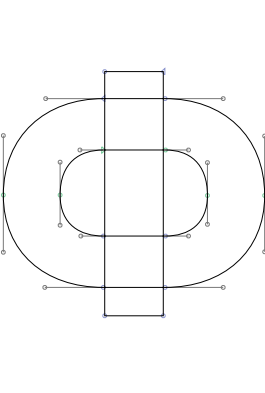

afii10038

0424

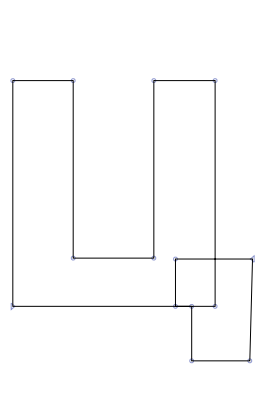

afii10040

0426

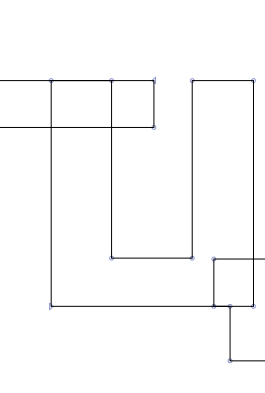

Tetsecyrillic

04B4

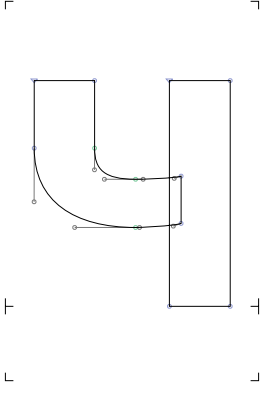

afii10041

0427

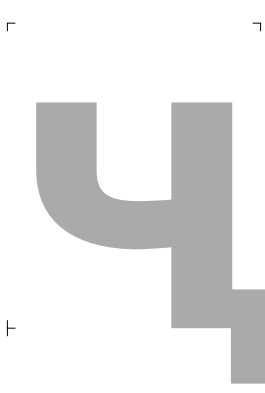

Chedescendercyrillic

04B6

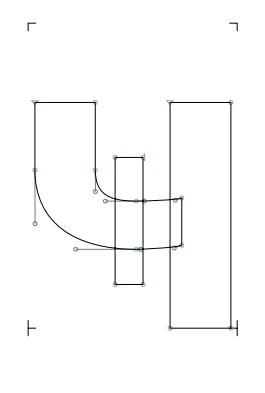

Cheverticalstrokecyrillic

04B8

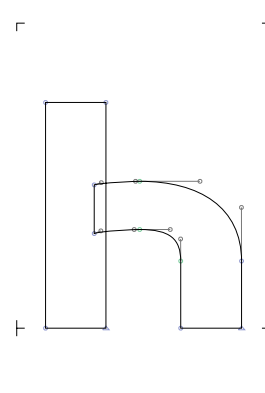

Shhacyrillic

04BA

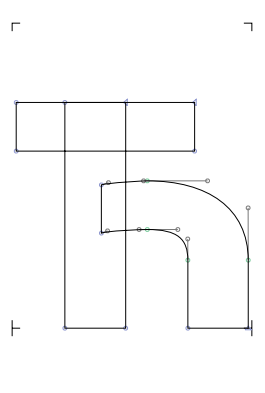

afii10060

040B

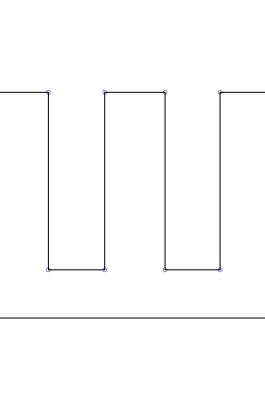

afii10042

0428

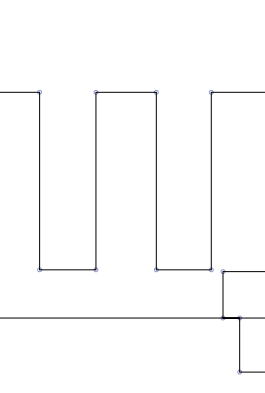

afii10043

0429

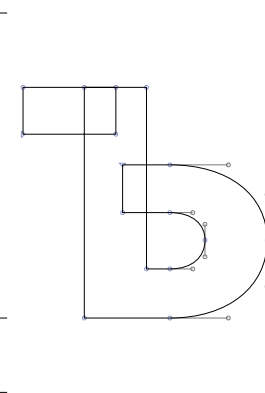

afii10044

042A



afii10045

042B

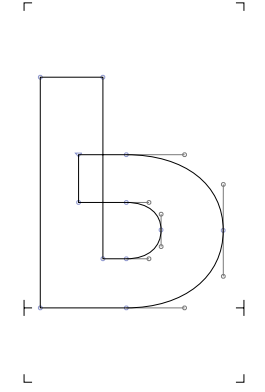

afii10046

042C

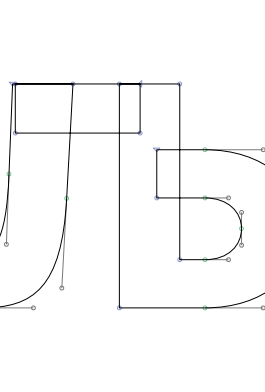

afii10058

0409

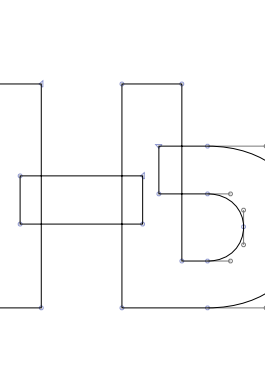

afii10059

040A

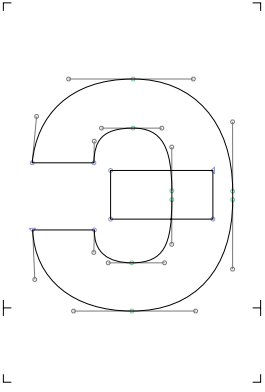

afii10047

042D



afii10048

042E

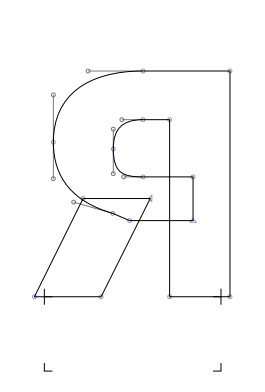

afii10049

042F

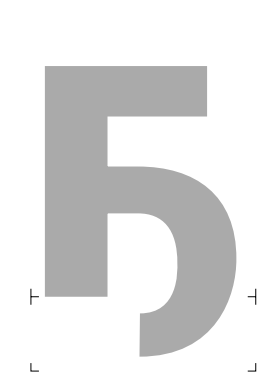

Ghemiddlehookcyrillic

0494



Pemiddlehookcyrillic

04A6

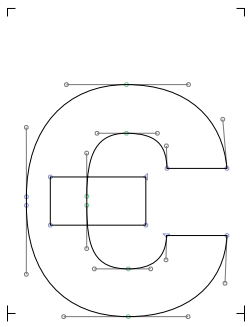

afii10053

0404

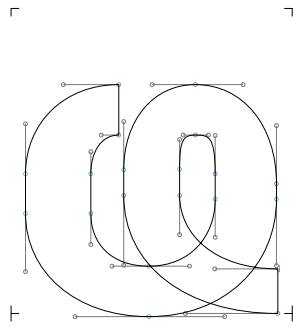

Haabkhasiancyrillic

04A8

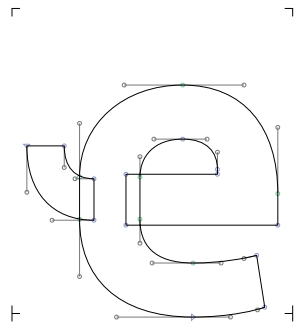

Cheabkhasiancyrillic

04BC

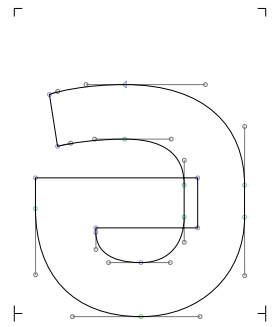

Schwacyrillic

04D8

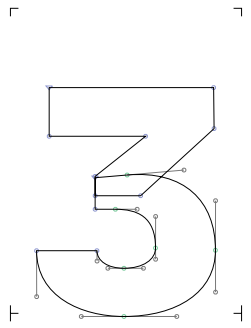

Dzeabkhasiancyrillic

04E0

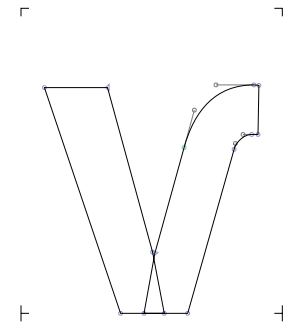

afii10148

0474

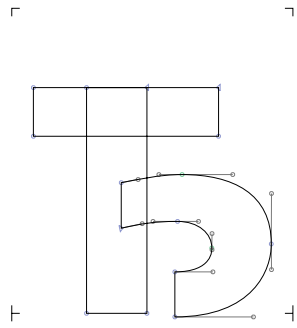

afii10051

0402

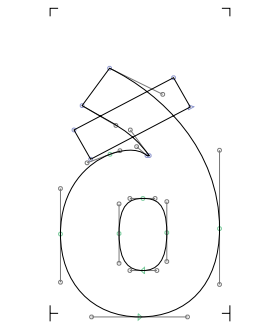

eth

00F0

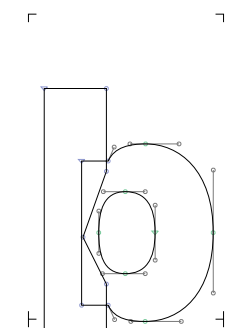

thorn

00FE

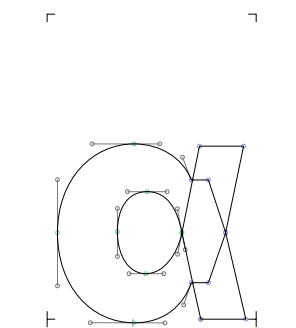

alpha

03B1



alphatonos

03AC

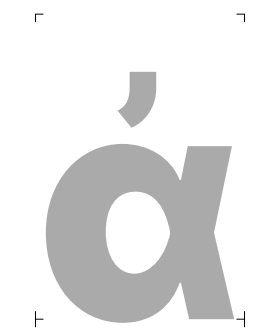

uni1F00

1F00



uni1F01

1F01

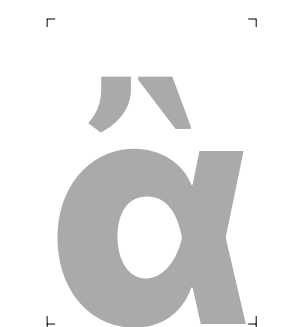

uni1F02

1F02

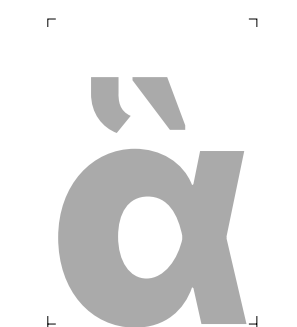

uni1F03

1F03



uni1F04

1F04



uni1F05

1F05

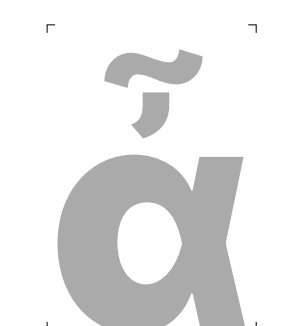

uni1F06

1F06

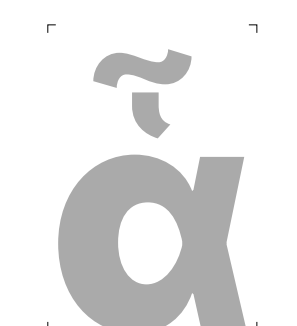

uni1F07

1F07

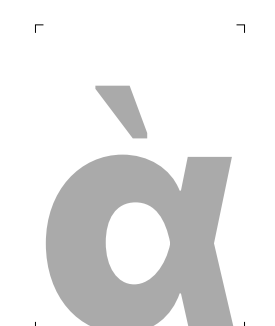

uni1F70

1F70

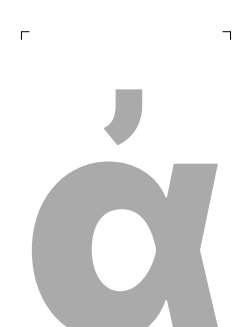

uni1F80

1F80

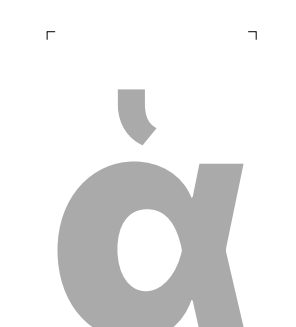

uni1F81

1F81

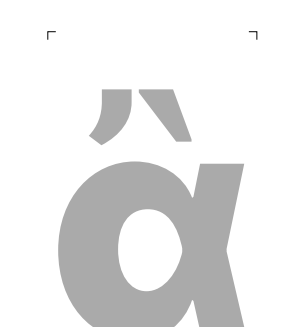

uni1F82

1F82

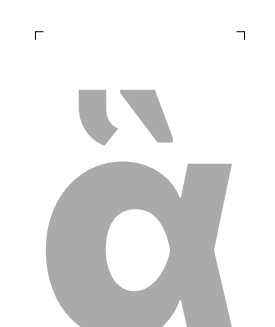

uni1F83

1F83



uni1F84

1F84



uni1F85

1F85



uni1F86

1F86



uni1F87

1F87



uni1F80

1F80



uni1F81

1F81



uni1F82

1F82



uni1F83

1F83



uni1FB4

1FB4



uni1FB6

1FB6



uni1FB7

1FB7

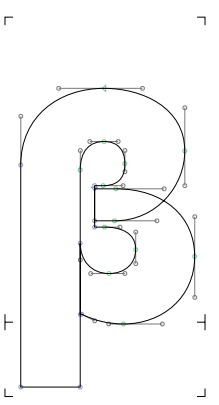

beta

03B2

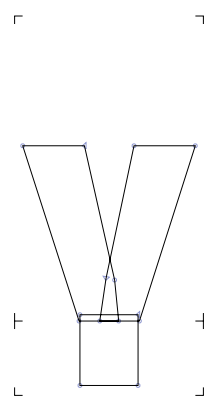

gamma

03B3

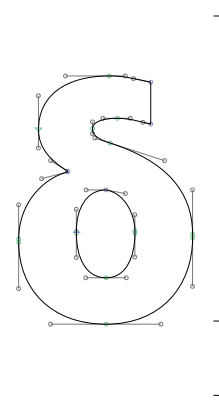

delta

03B4

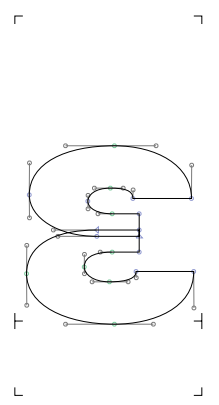

epsilon

03B5



epsilon-tonos

03AD

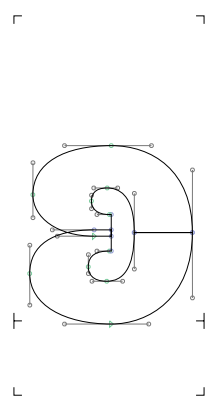

epsilon-closed

029A



epsilon-1

025B



epsilon-1-rev

025C

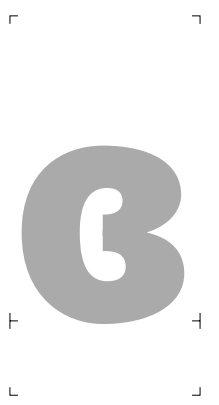

epsilon-1-rev-closed

025E

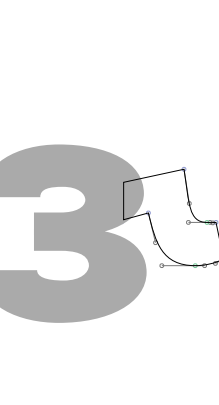

epsilon-1-rev-hook

025D



uni1F10

1F10



uni1F11

1F11



uni1F12

1F12



uni1F13

1F13



uni1F14

1F14



uni1F15

1F15



uni1F72

1F72

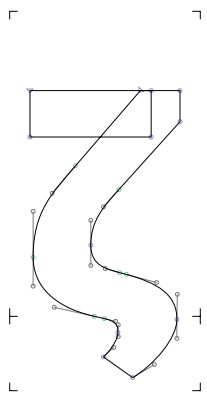

zeta

03B6

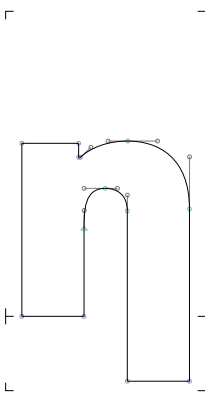

eta

03B7



etatonos

03AE



uni1F20

1F20



uni1F21

1F21



uni1F22

1F22



uni1F23

1F23



uni1F24

1F24



uni1F25

1F25



uni1F26

1F26



uni1F27

1F27

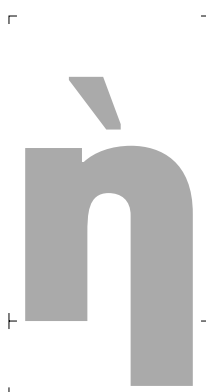

uni1F74

1F74



uni1F90

1F90



uni1F91

1F91



uni1F92

1F92



uni1F93

1F93



uni1F94

1F94



uni1F95

1F95



uni1F96

1F96



uni1F97

1F97



uni1FC2

1FC2



uni1FC3

1FC3



uni1FC4

1FC4



uni1FC6

1FC6



uni1FC7

1FC7

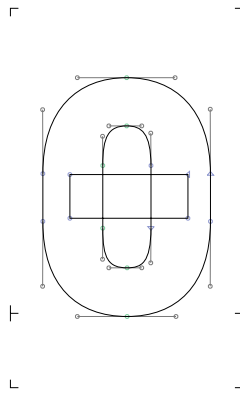

theta

03B8

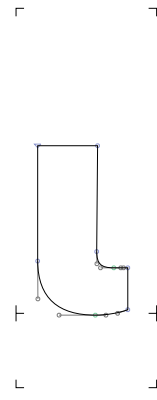

iota

03B9

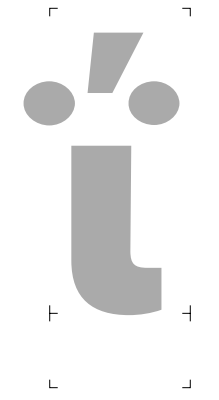

iotadiesisistos

0390



iotatonos

03AF



iotadiesis

03CA



uni1F30

1F30



uni1F31

1F31

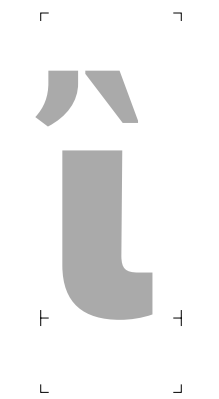

uni1F32

1F32



uni1F33

1F33



uni1F34

1F34



uni1F35

1F35

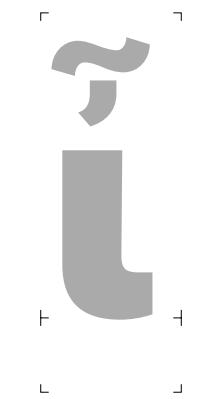

uni1F36

1F36



uni1F37

1F37



uni1F76

1F76

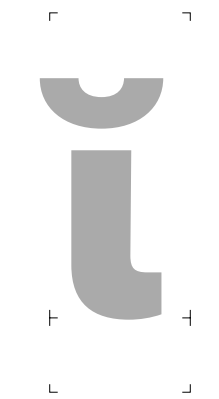

uni1FD0

1FD0



uni1FD1

1FD1



uni1FD2

1FD2



uni1FD6

1FD6

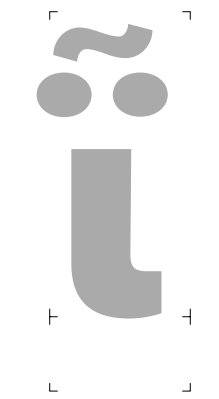

uni1FD7

1FD7

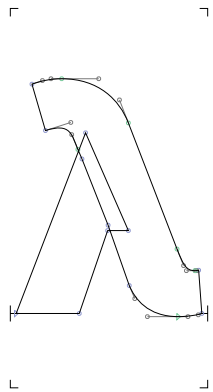

lambda

03BB

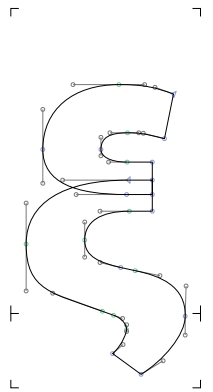

xi

03BE

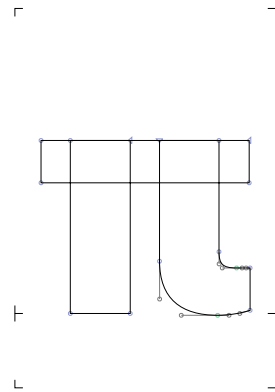

pi

03C0

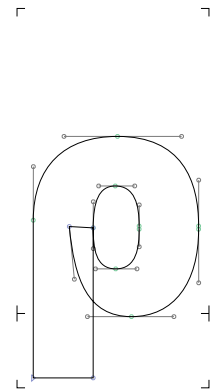

rho

03C1

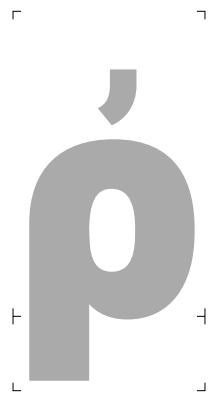

uni1FE4

1FE4

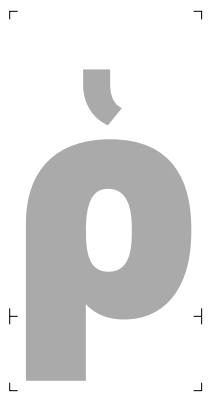

uni1FE5

1FE5

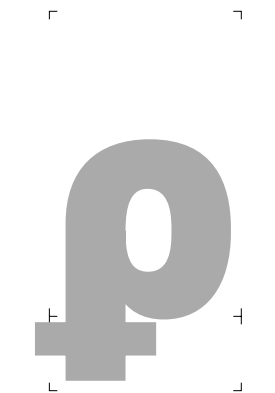

uni03FC

03FC

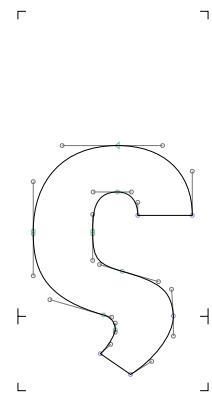

sigma1

03C2

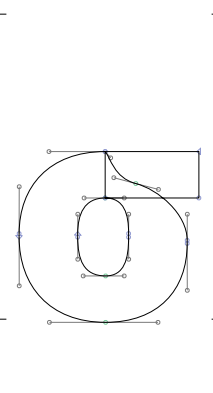

sigma

03C3

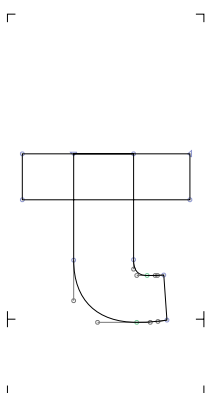

tau

03C4

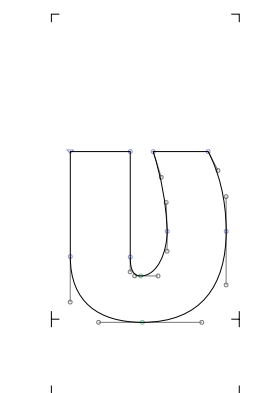

upsilon

03C5

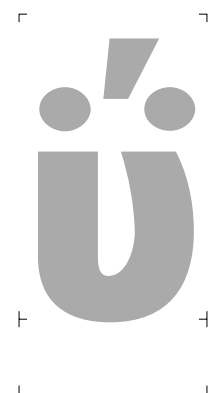

upsilondieresis

03B0

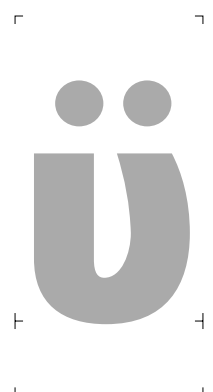

upsilondieresis

03CB



upsilontonos

03CD

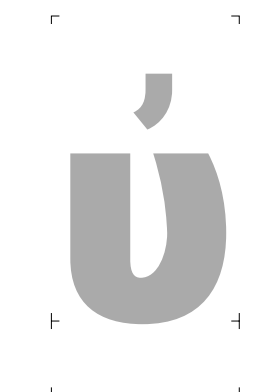

uni1F50

1F50



uni1F51

1F51

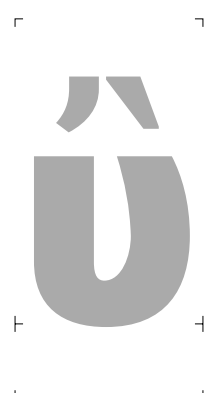

uni1F52

1F52



uni1F53

1F53

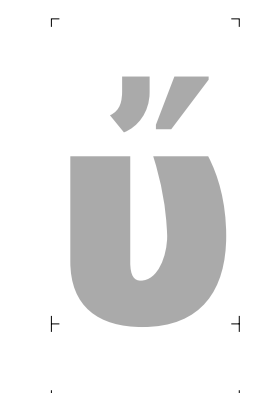

uni1F54

1F54

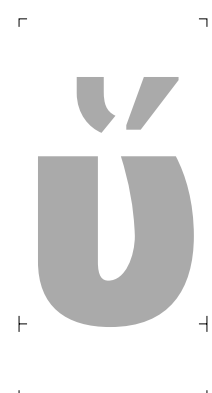

uni1F55

1F55

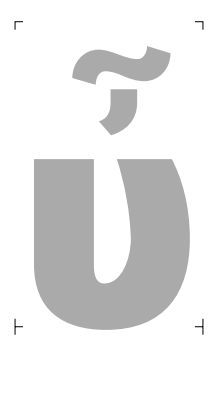

uni1F56

1F56

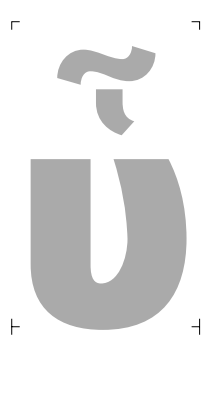

uni1F57

1F57

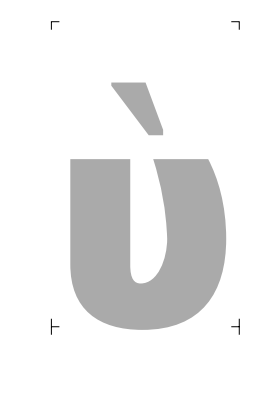

uni1F7A

1F7A

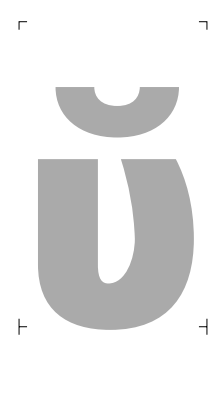

uni1FE0

1FE0

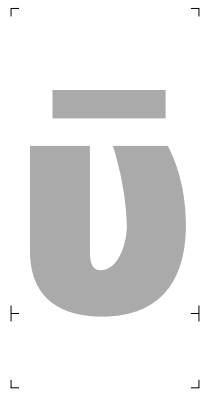

uni1FE1

1FE1



uni1FE2

1FE2

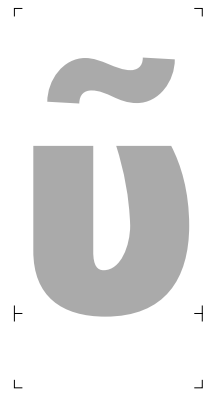

uni1FE6

1FE6



uni1FE7

1FE7

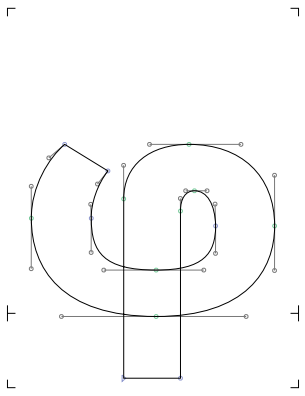

phi

03C6

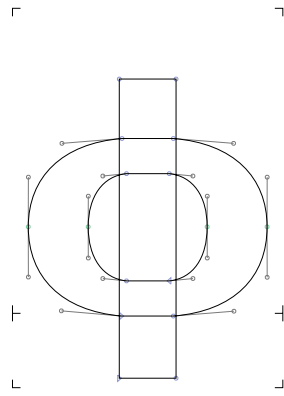

phigreek

03D5

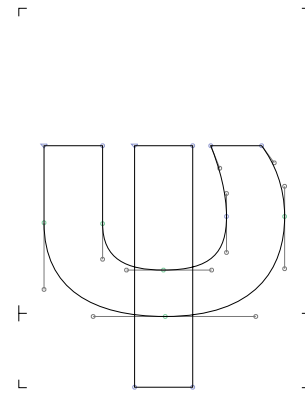

psi

03C8

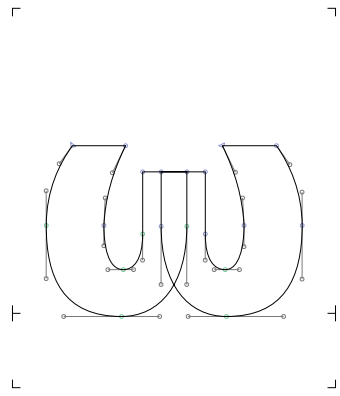

omega

03C9



omegatonos

03CE



uni1F60

1F60

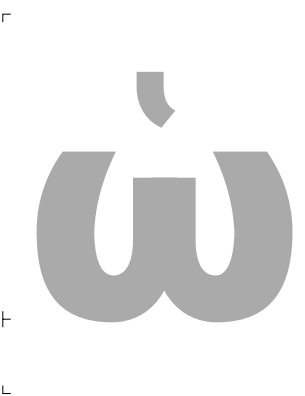

uni1F61

1F61

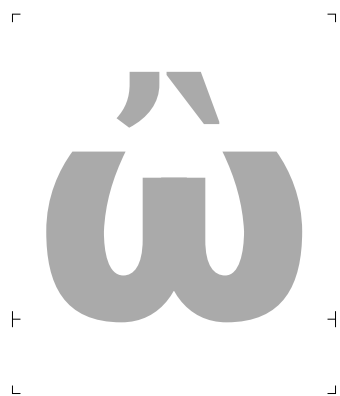

uni1F62

1F62



uni1F63

1F63



uni1F64

1F64



uni1F65

1F65

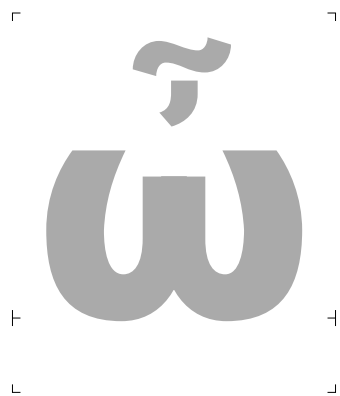

uni1F66

1F66

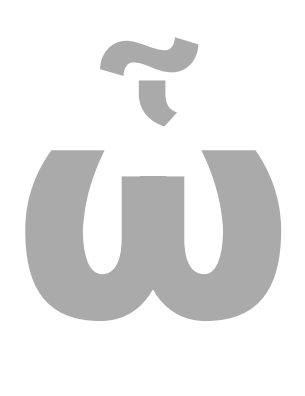

uni1F67

1F67



uni1F7C

1F7C



uni1FA0

1FA0

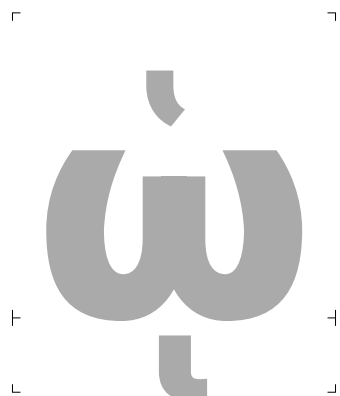

uni1FA1

1FA1

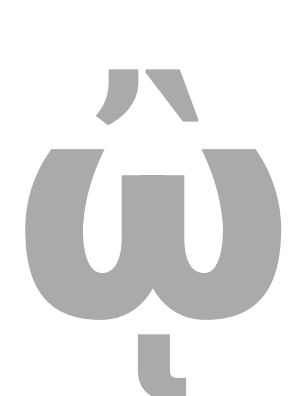

uni1FA2

1FA2



uni1FA3

1FA3



uni1FA4

1FA4

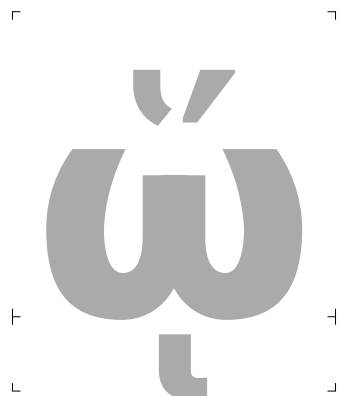

uni1FA5

1FA5

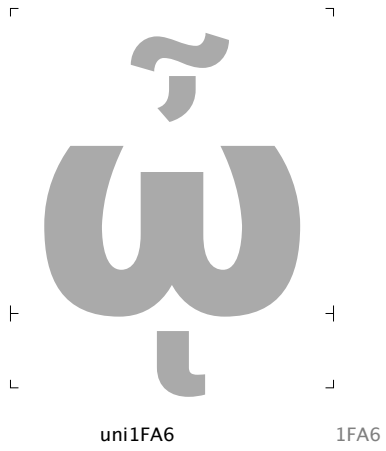

uni1FA6

1FA6

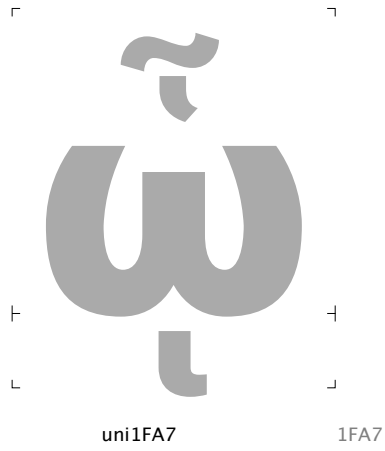

uni1FA7

1FA7

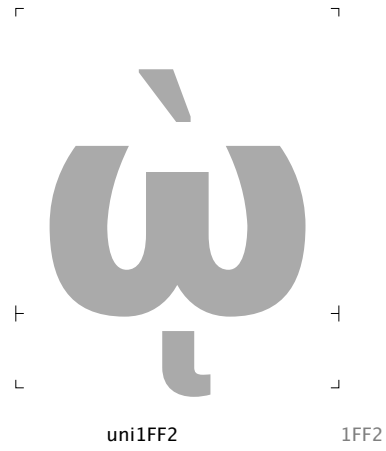

uni1FF2

1FF2

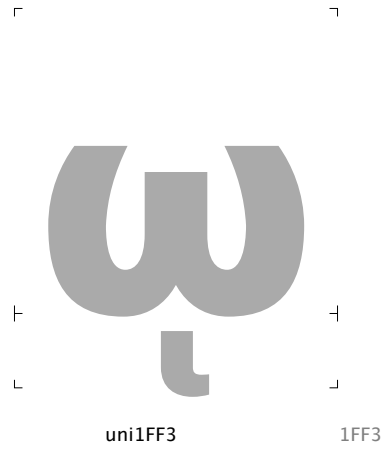

uni1FF3

1FF3

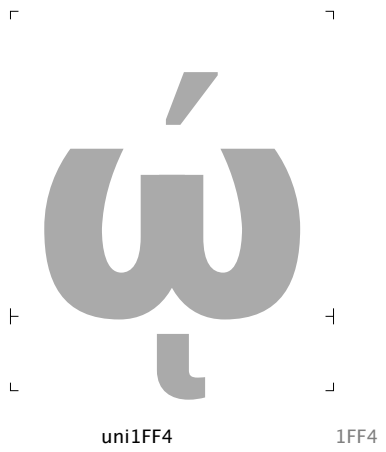

uni1FF4

1FF4

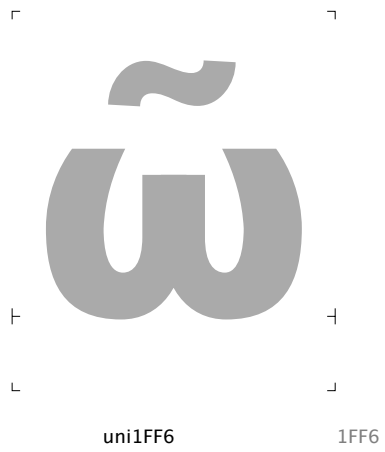

uni1FF6

1FF6

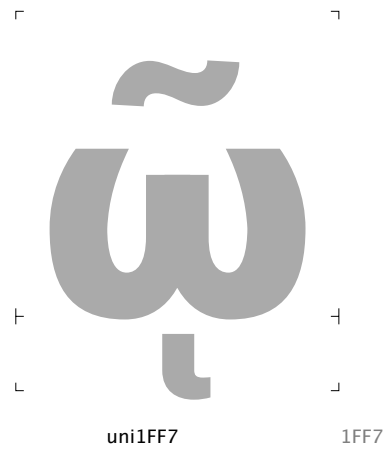

uni1FF7

1FF7

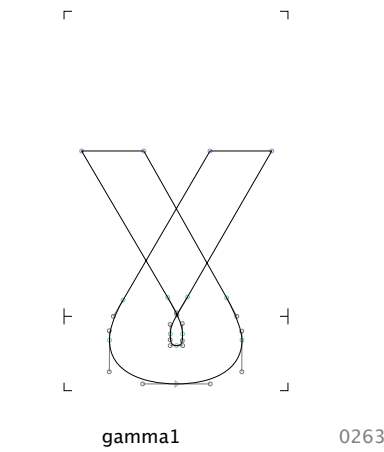

gamma1

0263

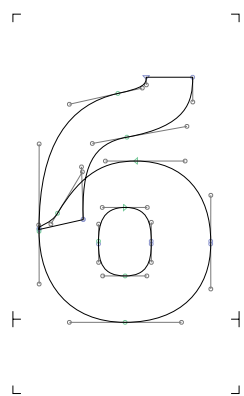

becyrillic

0431

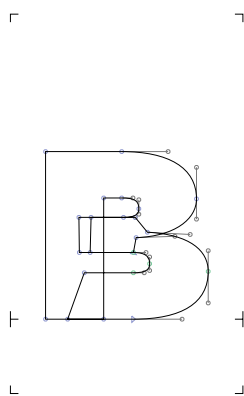

vecyrillic

0432

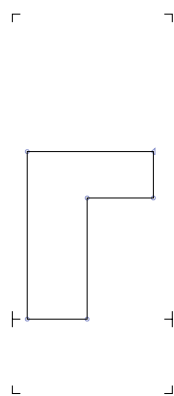

gecyrillic

0433

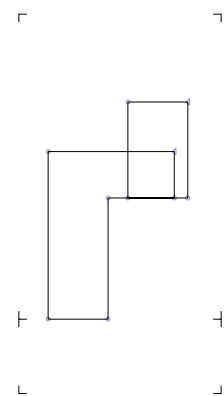

gheupturncyrillic

0491

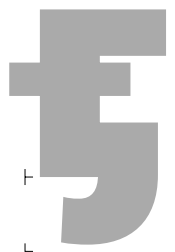

uni04FB

04FB

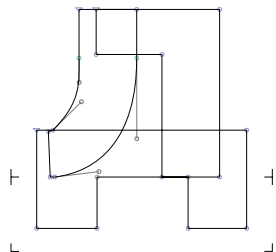

decyrillic

0434

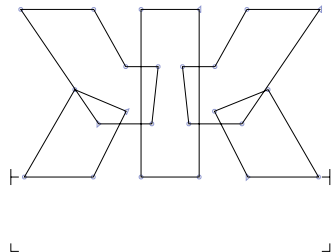

zhecyrillic

0436



zhedescendcyrillic

0497

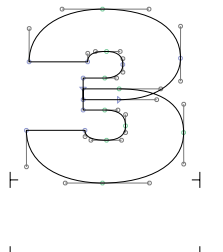

zecyrillic

0437

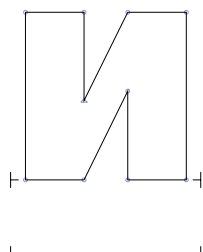

iicyrillic

0438



uni048B

048B

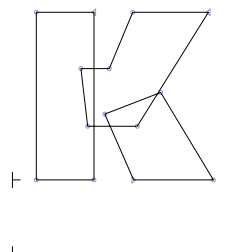

kacyrillic

043A

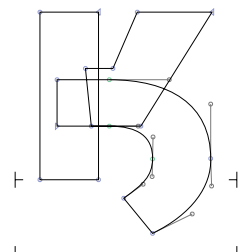

kahookcyrillic

04C4

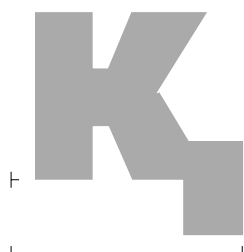

kadescendcyrillic

049B

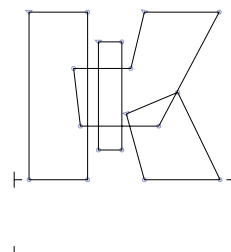

kaverticastrokescyrillic

049D

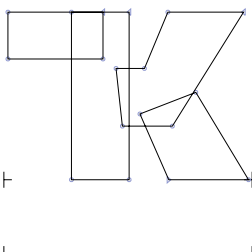

kabashkircyrillic

04A1

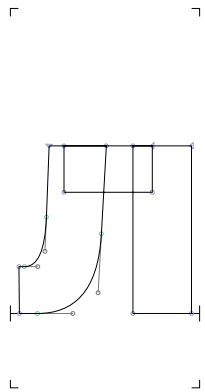

elcyrillic

043B



uni04C6

04C6

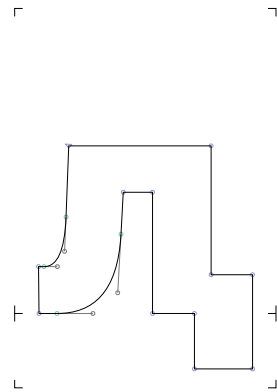

uni052F

052F

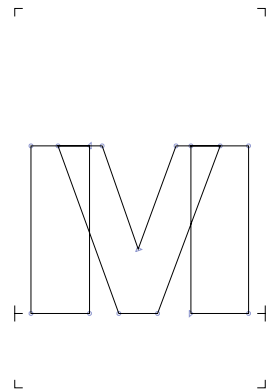

emcyrillic

043C



uni04CE

04CE

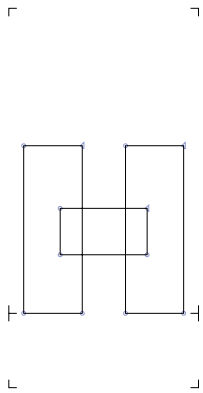

encyrillic

043D



endescendercyrillic

04A3

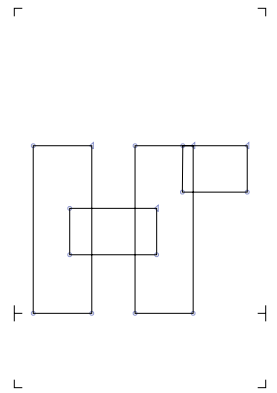

enghecyrillic

04A5

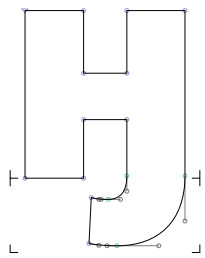

enhookcyrillic

04C8

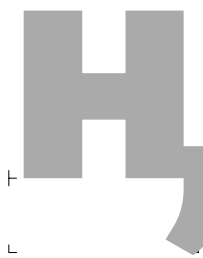

uni04CA

04CA

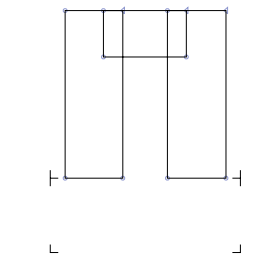

pecyrillic

043F

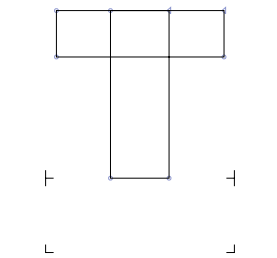

tecyrillic

0442

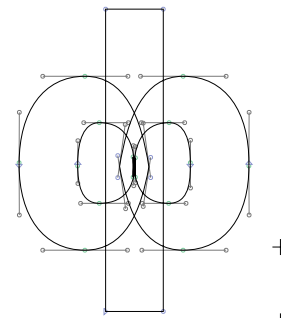

efcyrillic

0444

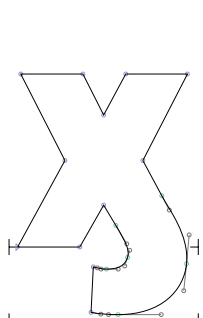

uni04FD

04FD

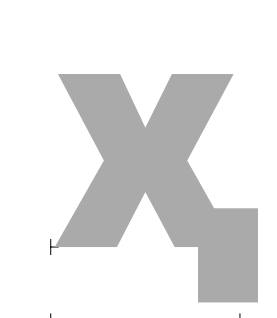

hadescendercyrillic

04B3

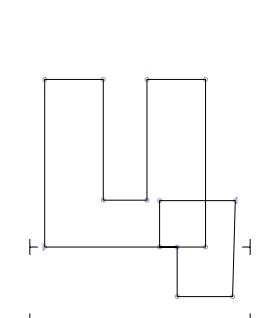

tsecyrillic

0446

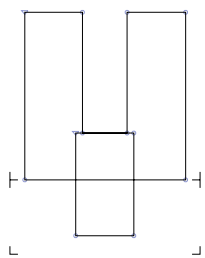

dzhecyrillic

045F

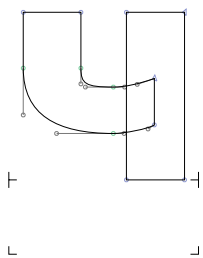

checyrillic

0447

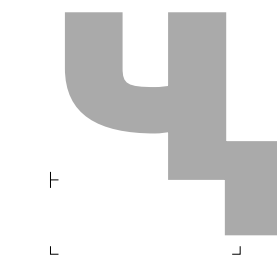

chedescendercyrillic

04B7

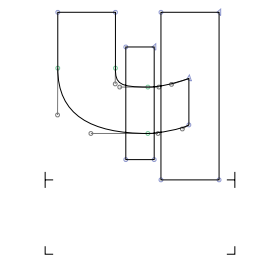

cheverticalstrokecyrillic

04B9

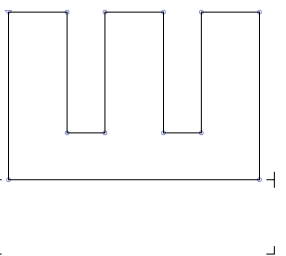

shacyrillic

0448

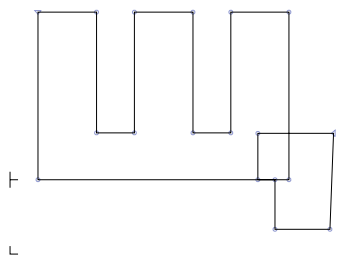

shchacyrillic

0449

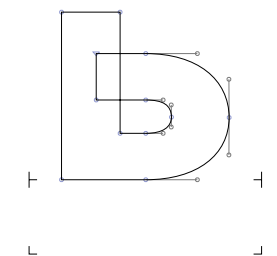

softsigncyrillic

044C

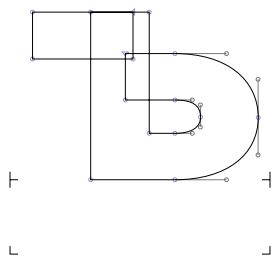

hardsigncyrillic

044A



yericyrillic 044B

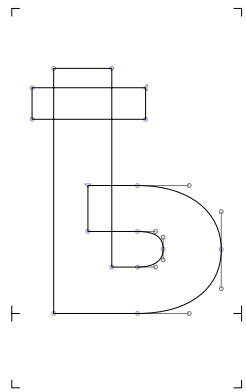

uni048D 048D

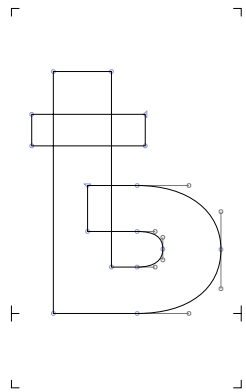

yatcyrillic 0463

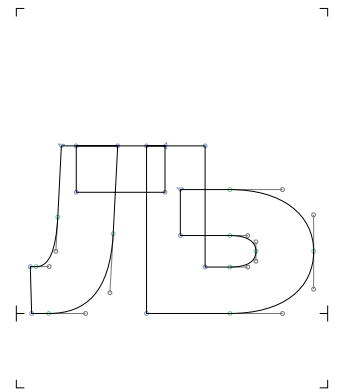

ljecyrillic 0459

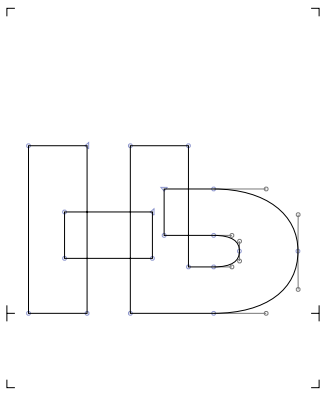

njecyrillic 045A

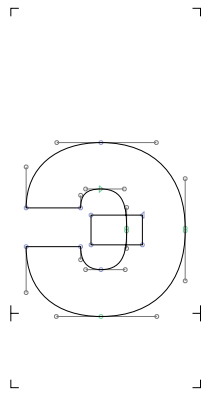

ereversedcyrillic 044D

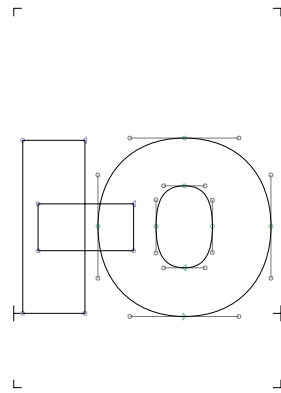

iucyrillic 044E

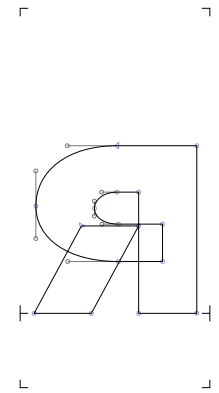

iacyrillic 044F

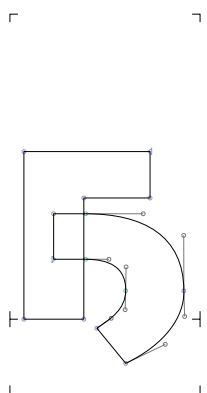

ghemiddlehookcyrillic 0495

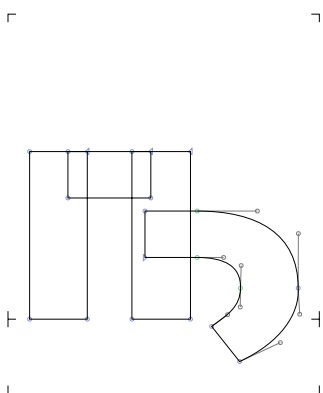

pemiddlehookcyrillic 04A7

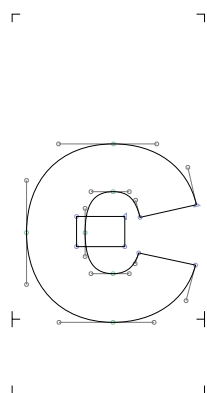

ecyrillic 0454

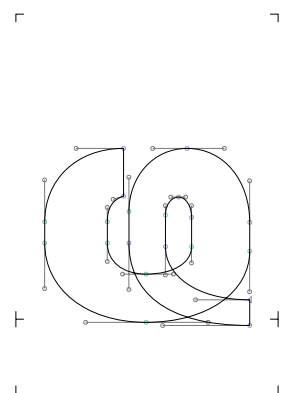

haabkhasiancyrillic 04A9

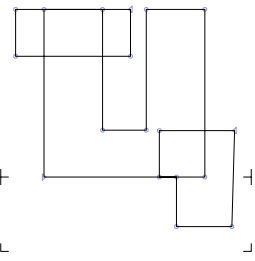

tetsecyrillic 04B5

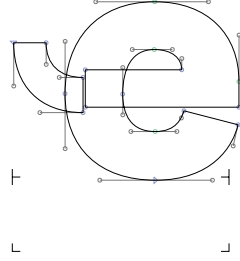

cheabkhasiancyrillic 04BD

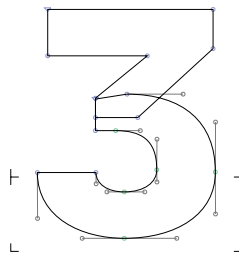

dzeabkhasiancyrillic 04E1

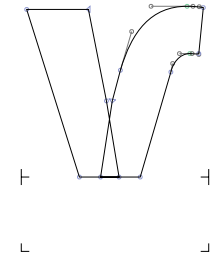

izhitsacyrillic 0475

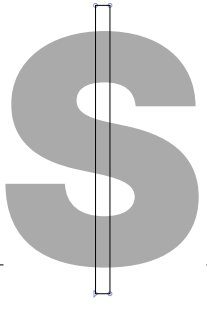

dollar 0024

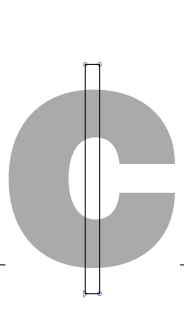

cent 00A2

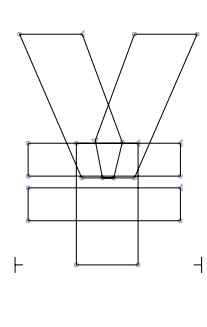

yen 00A5

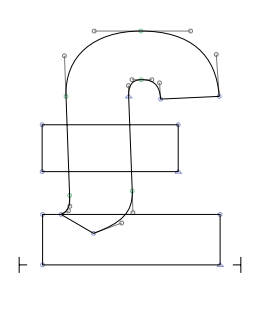

sterling 00A3

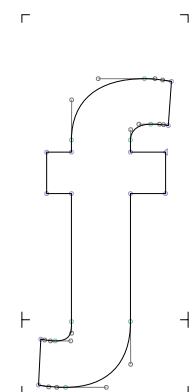

florin 0192

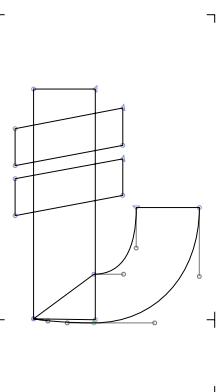

uni20BA 20BA

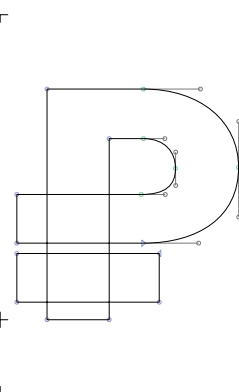

uni20BD 20BD

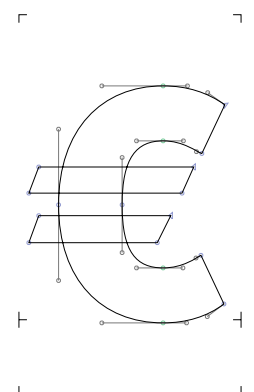

euro 20AC

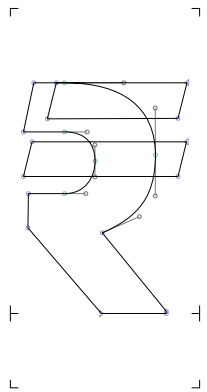

uni20B9

20B9

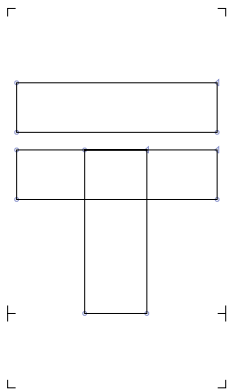

tenge

20B8

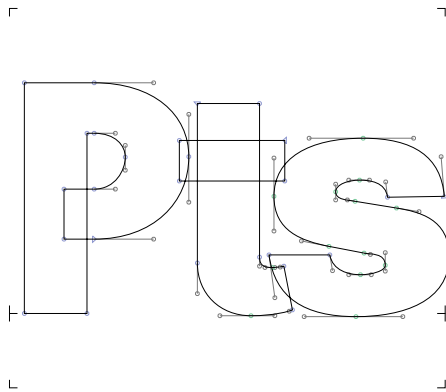

peseta

20A7

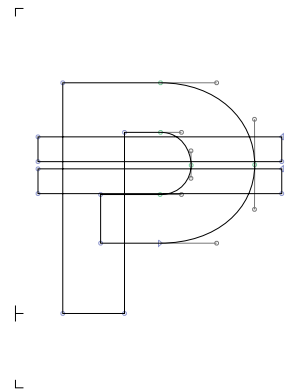

peso

20B1

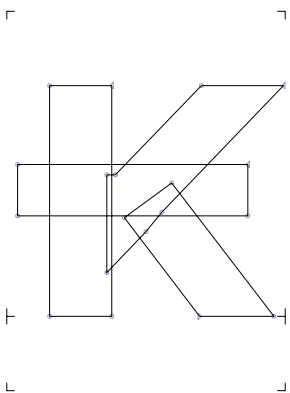

kip

20AD

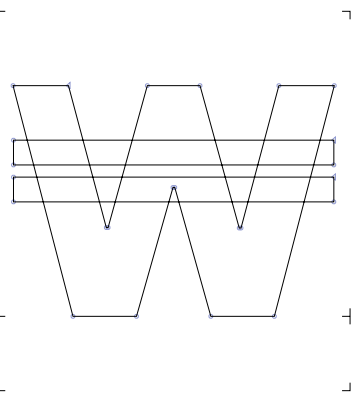

won

20A9

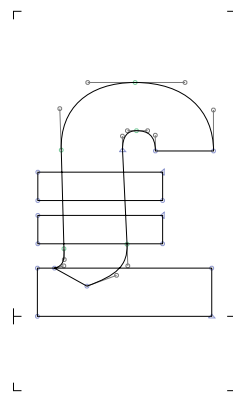

lira

20A4

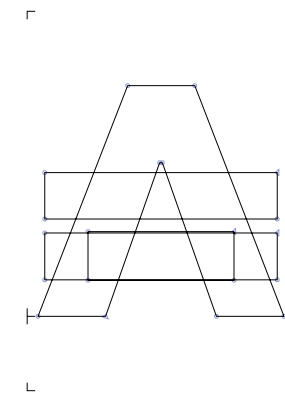

austral

20B3

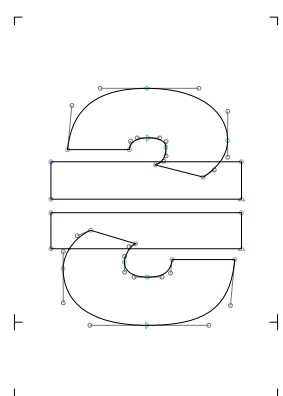

hryvnia

20B4

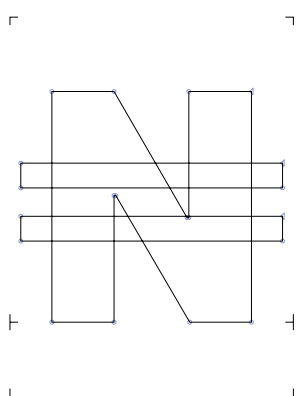

naira

20A6

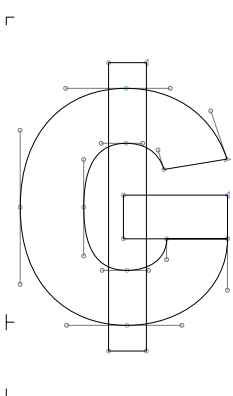

guarani

20B2

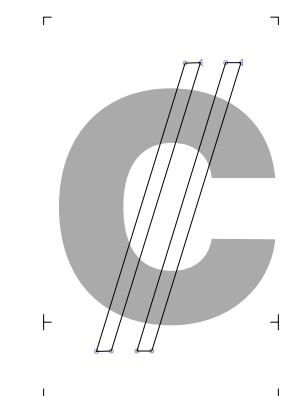

coloncurrency

20A1

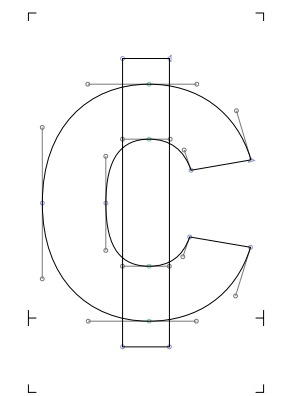

cedi

20B5

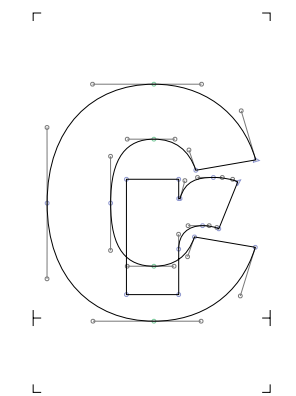

cruzeiro

20A2

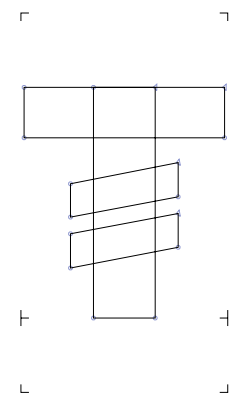

tugrik

20AE

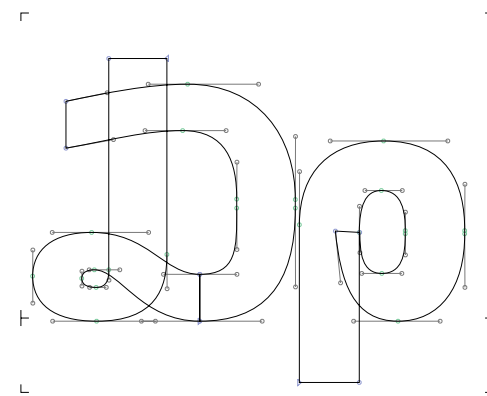

uni20AF

20AF

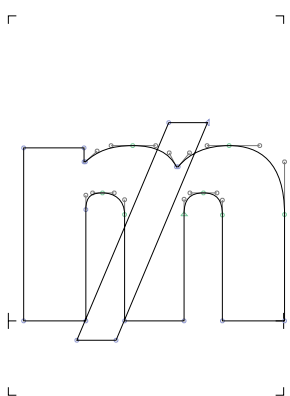

mill

20A5

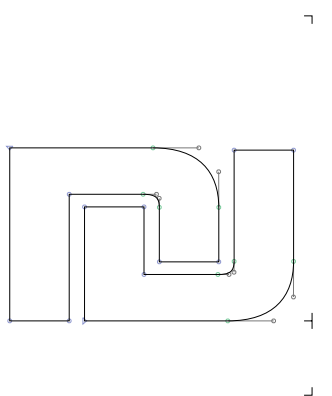

afi57636

20AA

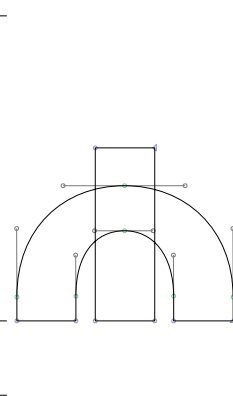

manat

20BC



rupee

20A8

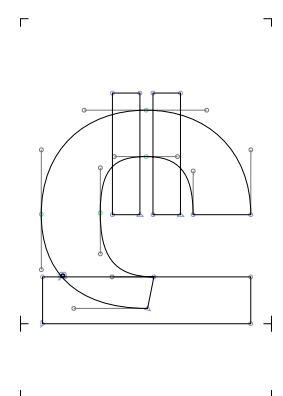

lari

20BE



franc

20A3

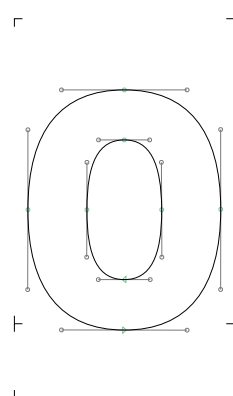

zero

0030

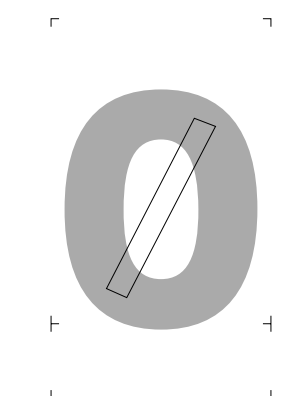

zero.slash

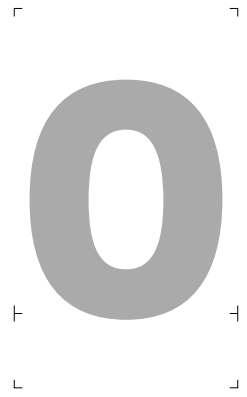

zero.tf

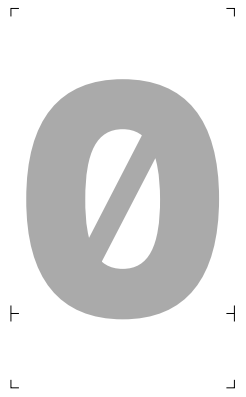

zero.tf.slash

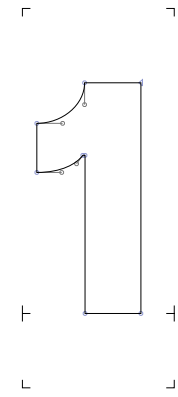

one

0031

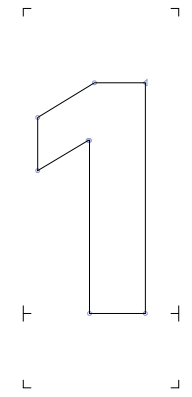

one.ss01

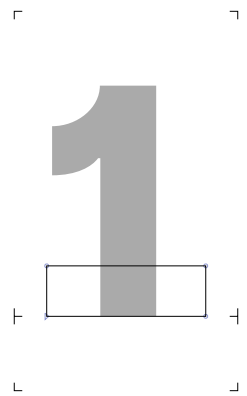

one.tf

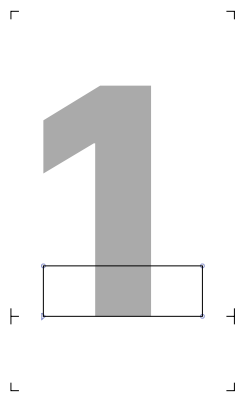

one.tf.ss01

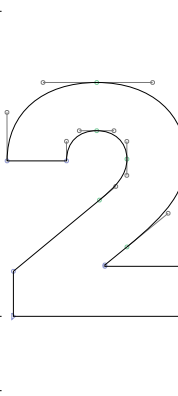

two

0032



two.tf



twostroke

01BB

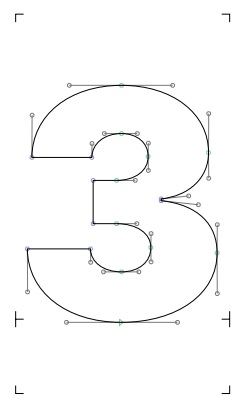

three

0033



three.tf

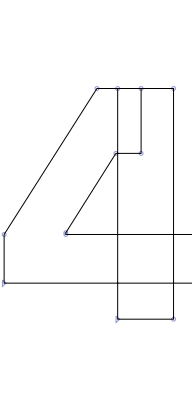

four

0034

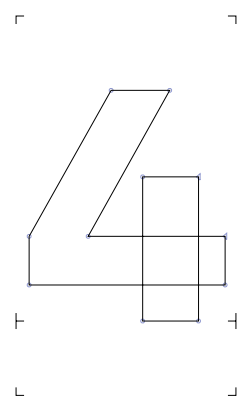

four.ss01



four.tf



four.tf.ss01

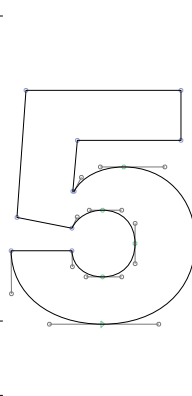

five

0035



five.tf

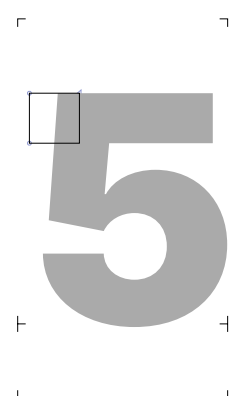

Tonefive

01BC

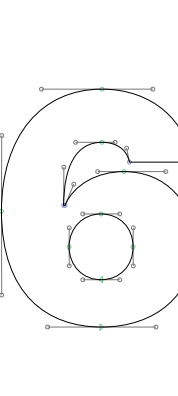

six

0036

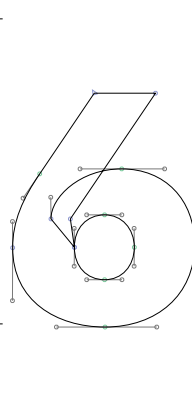

six.ss01



six.tf



six.tf.ss01

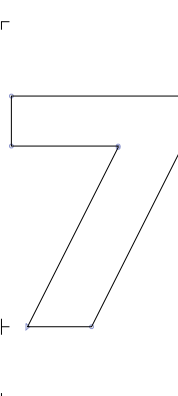

seven

0037



seven.tf

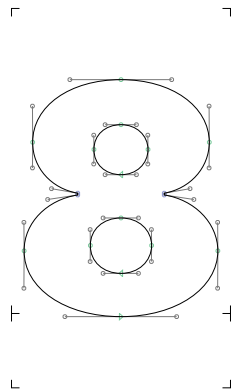

eight 0038

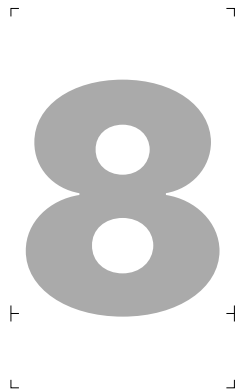

eight.tf

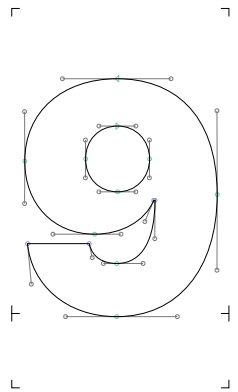

nine 0039

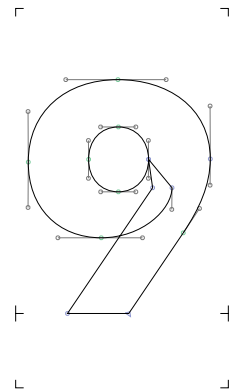

nine.ss01



nine.tf



nine.tf.ss01

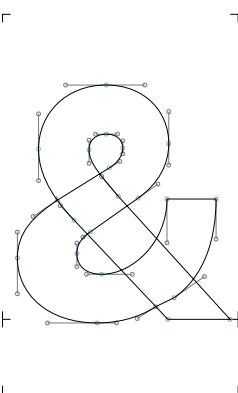

ampersand 0026

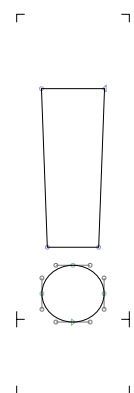

exclam 0021

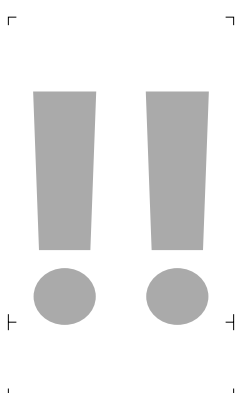

exclamdbl 203C

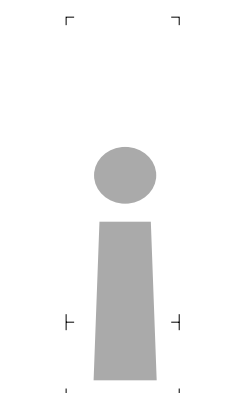

exclamdown 00A1



uni2049 2049

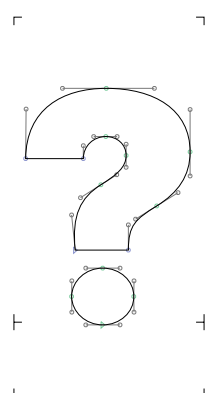

question 003F



uni2047 2047



uni2048 2048



questiondown 00BF

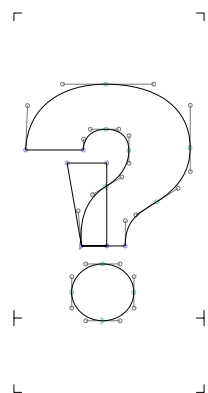

interrobang 203D



invertedinterrobang 2E18

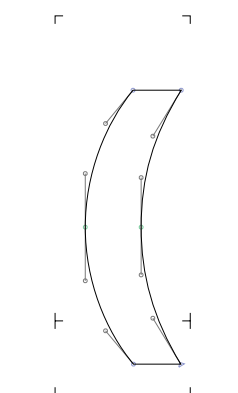

parenleft 0028

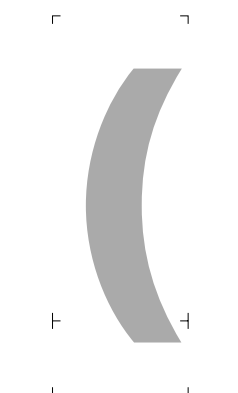

parenleft.case

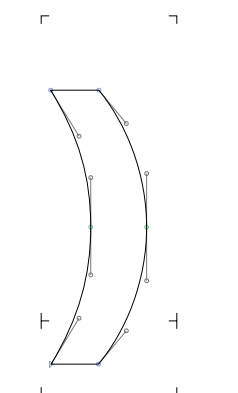

parenright 0029

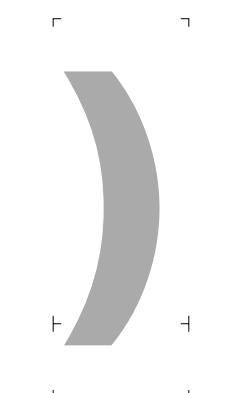

parenright.case

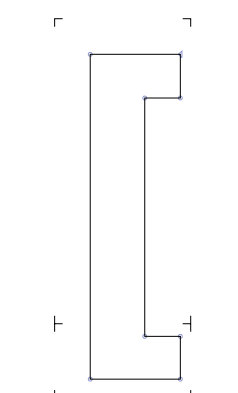

bracketleft 005B



bracketleft.case

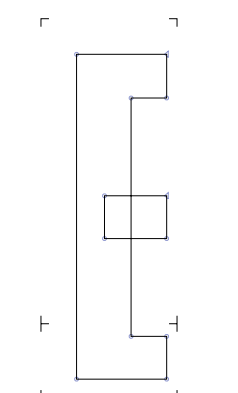

bracketleft_quill 2045

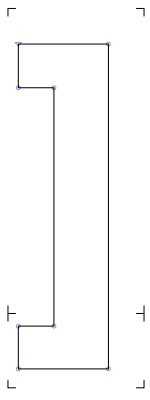

bracketright

005D



bracketright.case

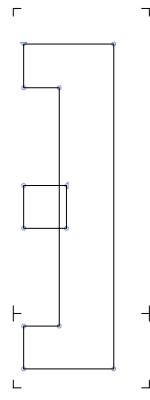

bracketright_quill

2046

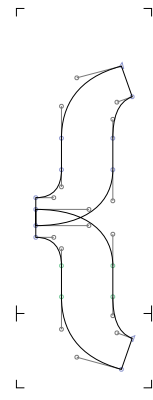

braceleft

007B



braceleft.case

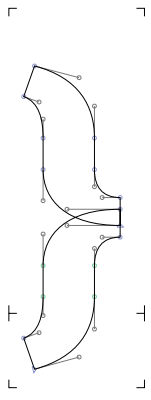

braceright

007D



braceright.case

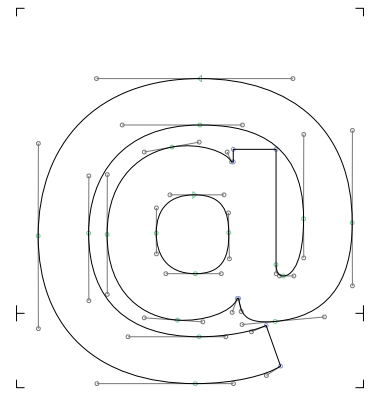

at

0040



at.case

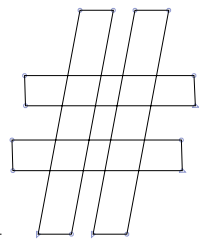

numbersign

0023

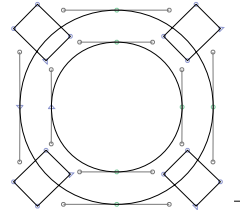

currency

00A4

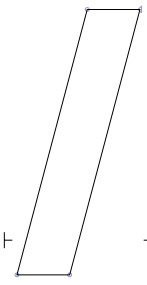

slash

002F

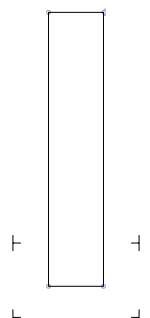

bar

007C

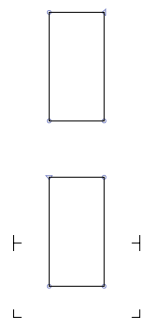

brokenbar

00A6

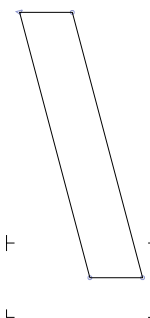

backslash

005C



hyphenbullet

2043



hyphen

002D



softhyphen

00AD



hyphen.case



endash

2013



enddash.case



figuredash

2012



figuredash.case



emdash

2014



emdash.case



horizontalbar

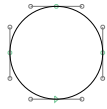

bullet



bullet.case

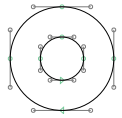

openbullet

25E6



openbullet.case



quoteleft

2018



quoteright

2019



apostrophemod

02BC

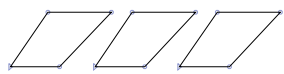

primetripl1

2034



quotesingle

0027



minute

2032



quotedbl

0022



second

2033



quotedblleft

201C



quotedblright

201D



quotedblbase

201E



quotesingbase

201A

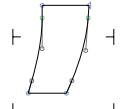

comma

002C

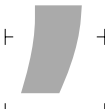

comma.tf

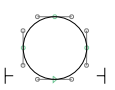

period

002E



period.tf



ellipsis

2026



twodotleader

2025

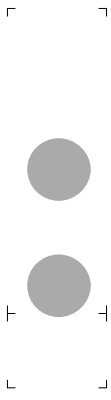

colon

003A

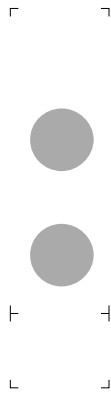

colon.case

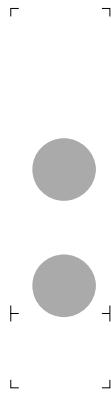

colon.tf



semicolon

003B



semicolon.tf



guilsingleft

2039

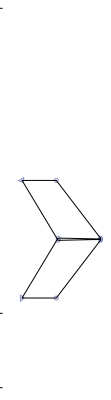

guilsingright

203A



guillemetleft

00AB



guillemetright

00BB

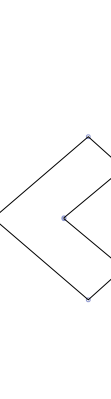

less

003C

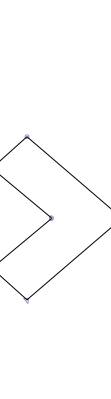

greater

003E

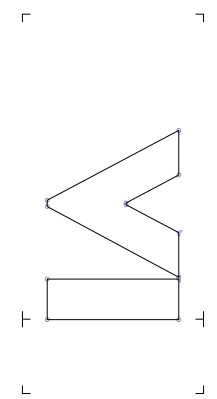

lessequal

2264

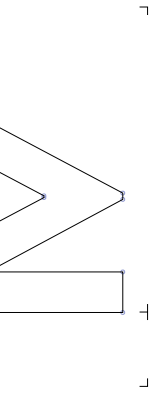

greaterequal

2265

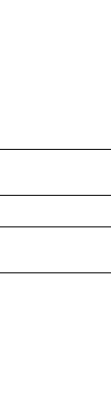

equal

003D



equal.case

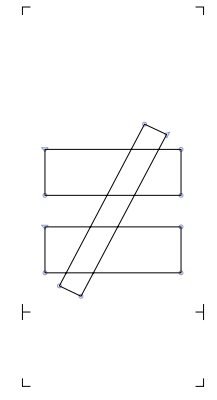

notequal

2260



notequal.case

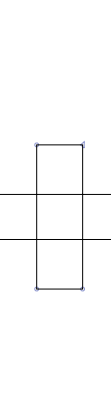

plus

002B



plus.case

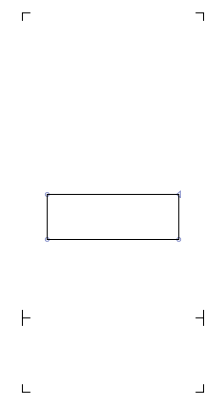

minus

2212



minus.case

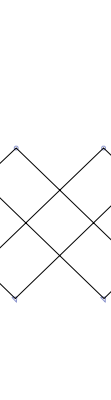

multiply

00D7



multiply.case

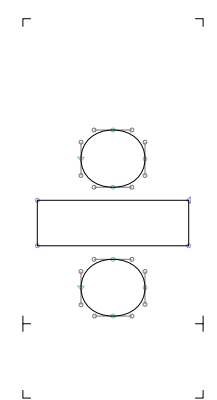

divide

00F7

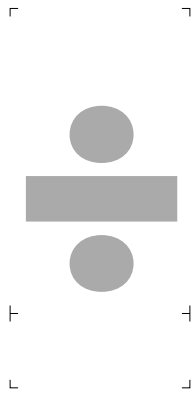

divide.case

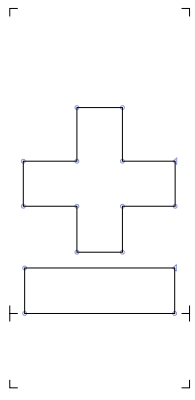

plusminus 00B1

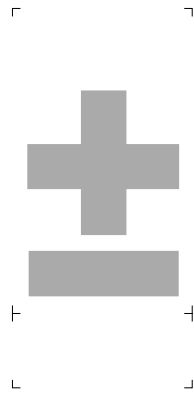

plusminus.case

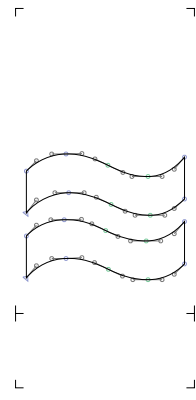

approxequal 2248

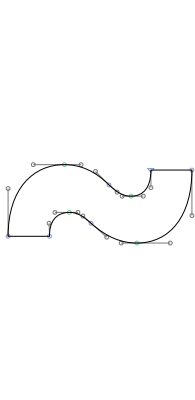

asciitilde 007E

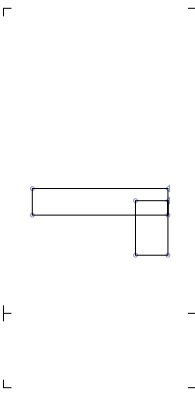

logicalnot 00AC

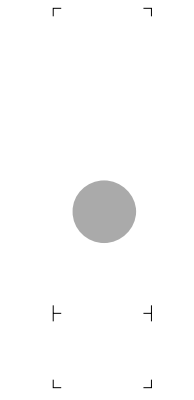

periodcentered 00B7

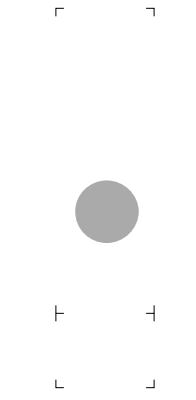

anoteleia 0387

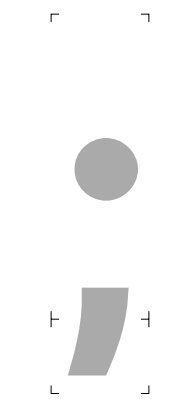

questiongreek 037E



underscore 005F

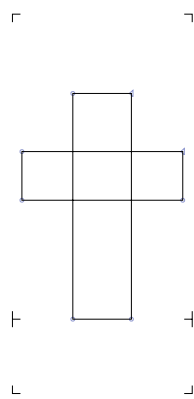

dagger 2020

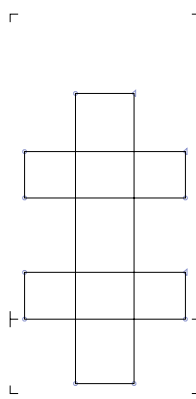

daggerdbl 2021

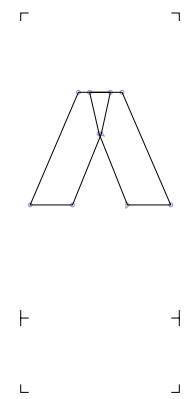

asciicircum 005E

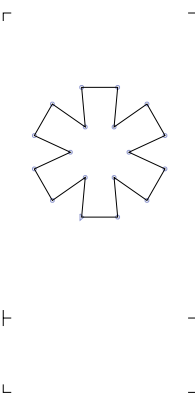

asterisk 002A

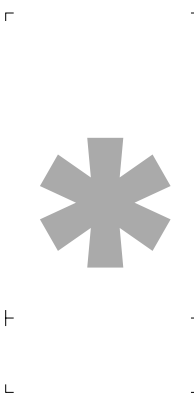

asterisk.case

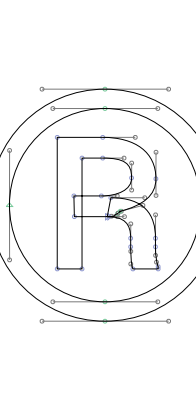

registered 00AE

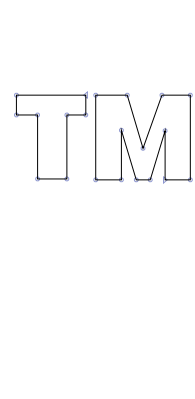

trademark 2122

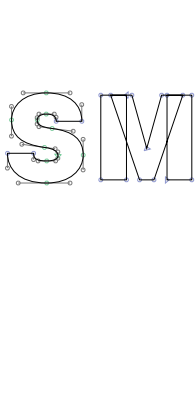

servicemark 2120

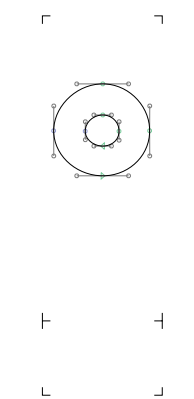

degree 00B0

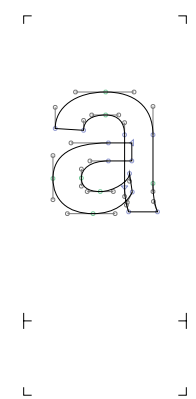

ordfeminine 00AA

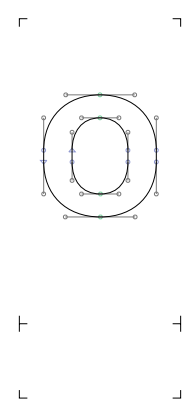

ordmasculine 00BA

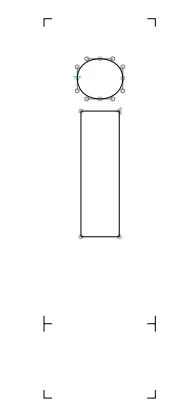

i.numr

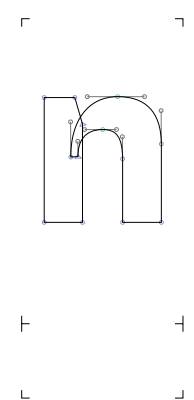

n.numr

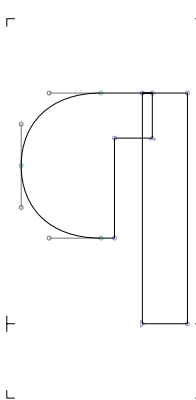

paragraph 00B6

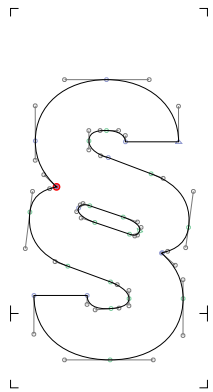

section 00A7

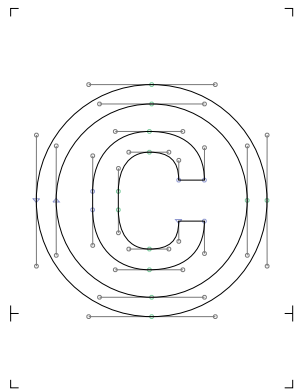

copyright 00A9

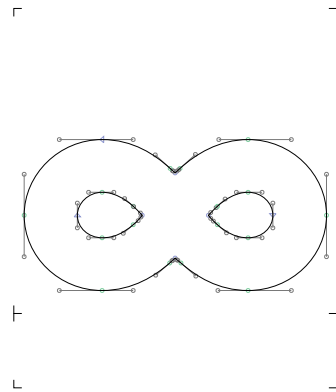

infinity 221E

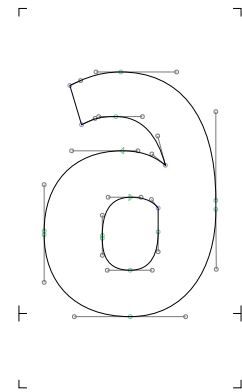

partialdiff 2202

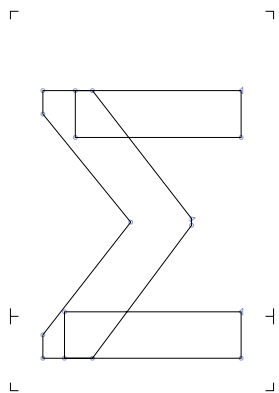

summation 2211

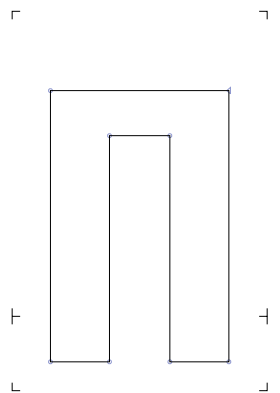

product 220F

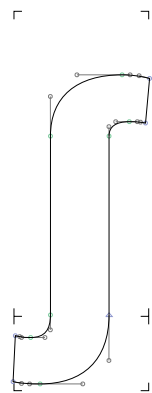

integral 222B

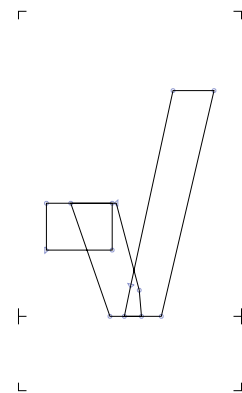

radical 221A

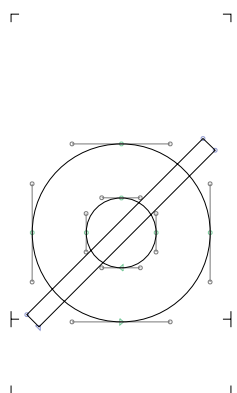

emptyset 2205

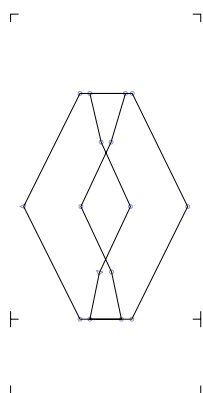

lozenge 25CA

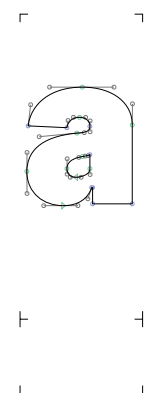

a.sups 1D43

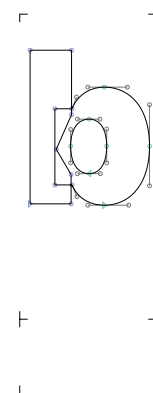

b.sups 1D47

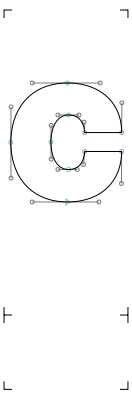

c.sups 1D9C

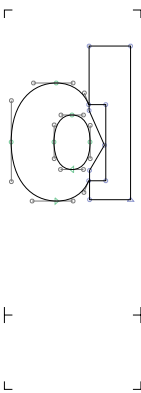

d.sups 1D48

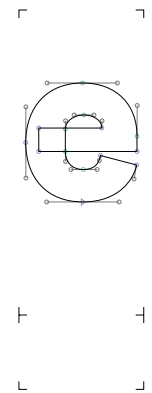

e.sups 1D49

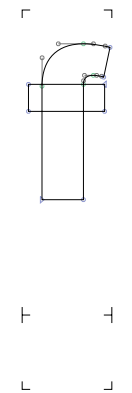

f.sups 1DA0

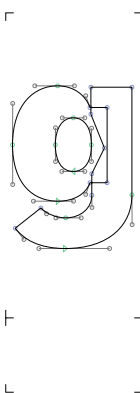

g.sups 1D4D

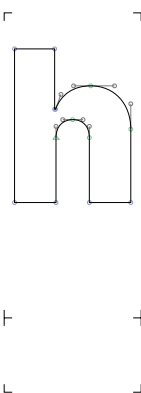

h.sups 02B0

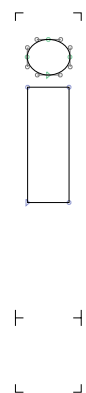

i.sups 2071

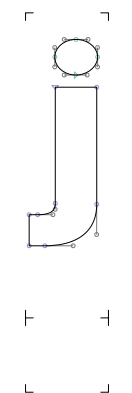

j.sups 02B2

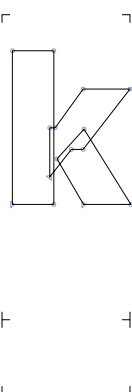

k.sups 1D4F

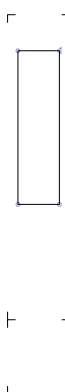

l.sups 02E1

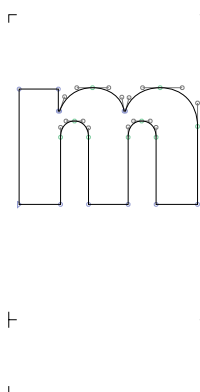

m.sups 1D50

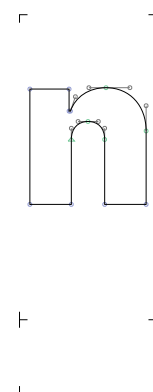

n.sups 207F

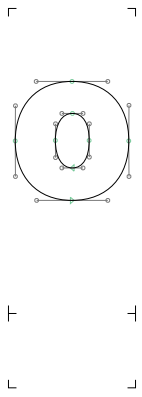

o.sups

1D52

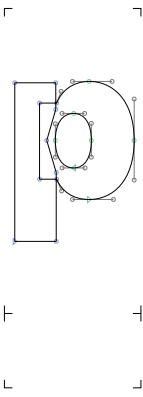

p.sups

1D56

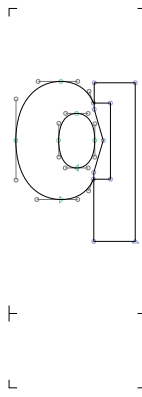

q.sups

146B

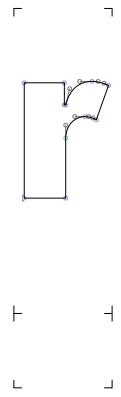

r.sups

02B3

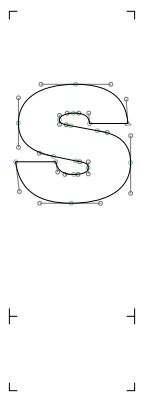

s.sups

02E2

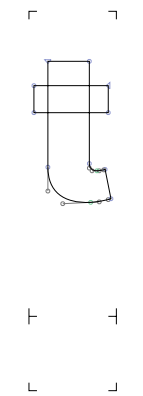

t.sups

1D57

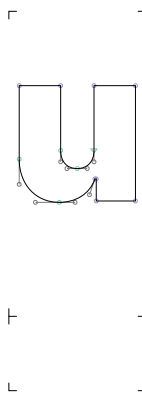

u.sups

1D58

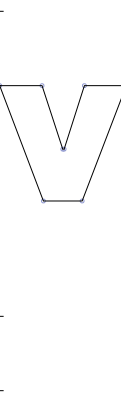

v.sups

1D5B

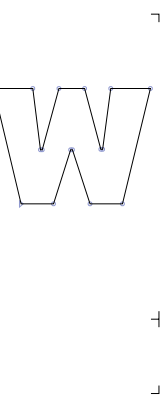

w.sups

02B7

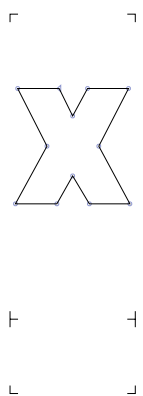

x.sups

02E3



y.sups

02B8

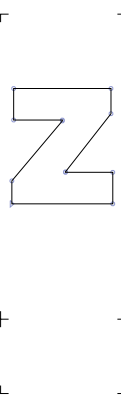

z.sups

1DBB

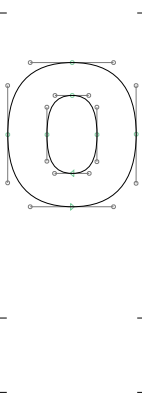

zero.sups

2070

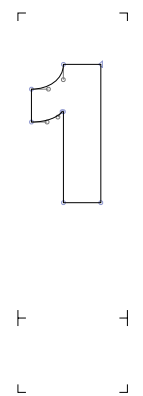

one.sups

00B9

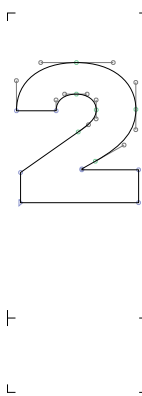

two.sups

00B2

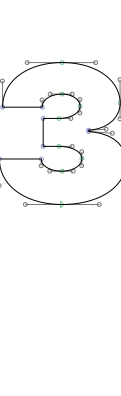

three.sups

00B3

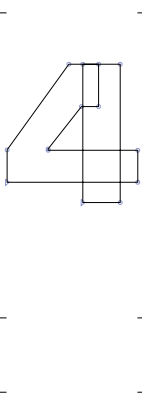

four.sups

2074

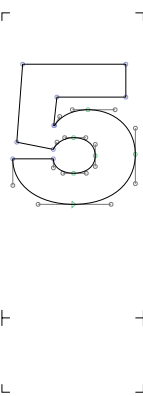

five.sups

2075

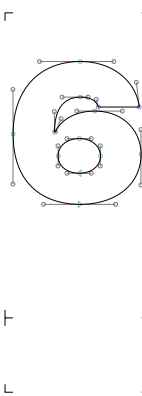

six.sups

2076

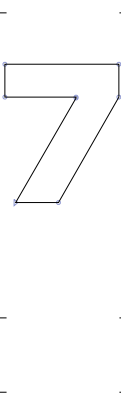

seven.sups

2077

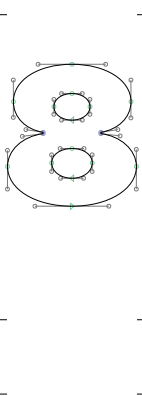

eight.sups

2078

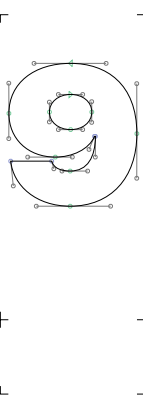

nine.sups

2079

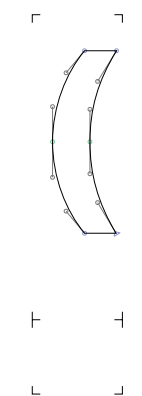

parenleft.sups

207D

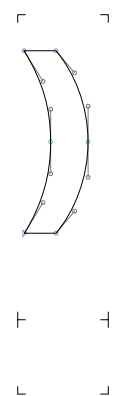

parenright.sups

207E

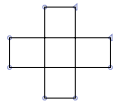

plus.sups

207A

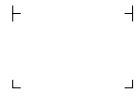

minus.sups

207B

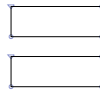

equal.sups

207C

a



a.sups

2090

b



b.sups

c



c.sups

d



d.sups

e



e.sups

2091

f



f.sups

g



g.sups

h



h.sups

2095

i



i.sups

1D62

j



j.sups

2C7C

k



k.sups

2096

l



l.sups

2097

m



m.sups

2098

n



n.sups

2099

o



o.sups

2092

p



p.sups

209A

q



q.sups

r



r.sups

1D63

s

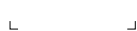

s.sups

209B

t



t.sups

209C

u



u.sups

1D64

V

v.subs 1D65

W

w.subs

X

x.subs 2093

y

y.subs

Z

z.subs

0

zero.subs 2080

1

one.subs 2081

2

two.subs 2082

3

three.subs 2083

4

four.subs 2084

5

five.subs 2085

6

six.subs 2086

7

seven.subs 2087

8

eight.subs 2088

9

nine.subs 2089

(

parenleft.subs 208D

)

parenright.subs 208E

+

plus.subs 208A

-

minus.subs 208B

=

equal.subs 208C

0

zero.dnomf

1

one.dnomf

2

two.dnomf

3

three.dnomf

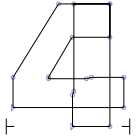

four.dnomf

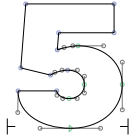

five.dnomf

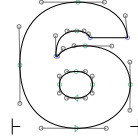

six.dnomf

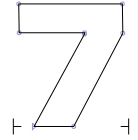

seven.dnomf

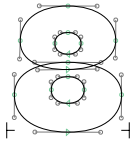

eight.dnomf



nine.dnomf

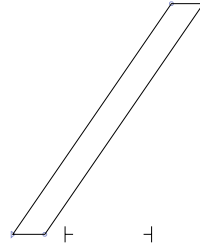

fraction 2044

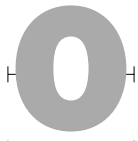

zero.dnom



one.dnom



two.dnom

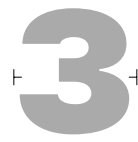

three.dnom



four.dnom



five.dnom



six.dnom



seven.dnom

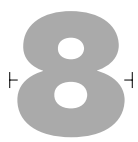

eight.dnom



nine.dnom



plus.dnom



minus.dnom



equal.dnom

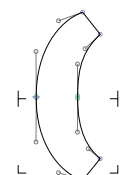

parenleft.dnom

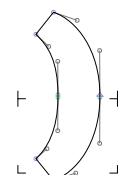

parenright.dnom

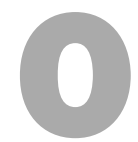

zero.numr



one.numr

2



two.numr

3



three.numr

4



four.numr

5



five.numr

6



six.numr

7

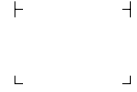

seven.numr

8

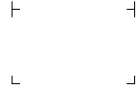

eight.numr

9



nine.numr

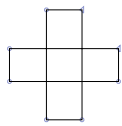

plus.numr

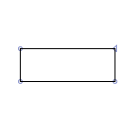

minus.numr

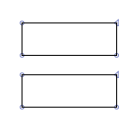

equal.numr

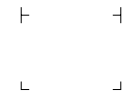
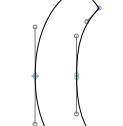

parenleft.numr

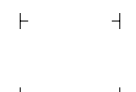
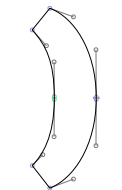

parenright.numr

0

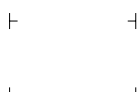

zero.frac

1

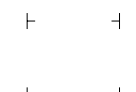

one.frac

2



two.frac

3



three.frac

4



four.frac

5



five.frac

6



six.frac

7



seven.frac

8



eight.frac

9



nine.frac

1/2



onehalf

00BD

1/4

onequarter

00BC

3/4

threequarters

00BE

5/6

fivesixths

215A

1/

onefraction

215F

7/8

seveneighths

215E

1/8

oneeighth

215B

5/8

fiveeighths

215D

3/8

threeeighths

215C

0/0

percent

0025

0/00

perthousand

2030

0/000

pertenthousand

2031

A/S

uni214D

214D

C/U

cadauna

2106

C/O

careof

2105

a/C

accountof

2100

a/S

addresssubject

2101

No

numero

2116

◌´

acute

00B4

◌˝

hungarumlaut

02DD

◌˘

grave

0060

◌ˆ

tonos

0384

◌¨

dieresis

00A8

◌̂

casedieresis.cn

◌̃

circumflex

02C6

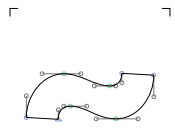

tilde 02DC



casetilde.cn

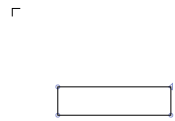

macron 00AF

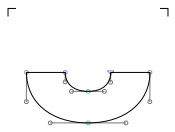

breve 02D8



cyrillicbreve



dotaccent 02D9



ring 02DA

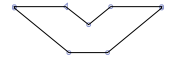

caron 02C7

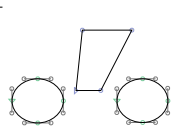

dieresistonos 0385

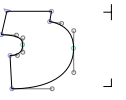
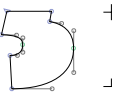

cedilla 00B8

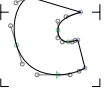
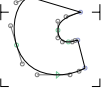

ogonek 02DB

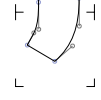
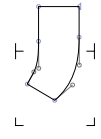

commaaccent F6C3



acutecomb 0301



acutedblnosp 030B

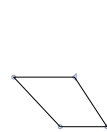

gravecomb 0300

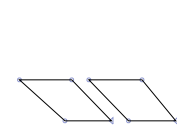

dblgravecmb 030F

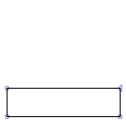

macroncomb 0304



dieresisnosp 0308



brevenosp 0306



breveinvnosp 0311



hook 0309



circumflexnosp 0302

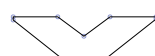

caroncmb 030C



tildecomb 0303



π



π



π



π

H

u

H

u

H

u

H

u

dotnosp

0307

ringnosp

030A

hornnosp

031B

ogoneknosp

0328

π

π

π

π



H

u



H

u

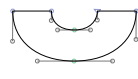

H

u



H

u

cedillanosp

0327

circumflexsubnosp

032D

brevesubnosp

032E

dotbelow

0323

π

π

π

π



H

u



H

u



H

u



H

u

commabelowcmb

0326

dotdblsubnosp

0324

ringsubnosp

0325

underscorenosp

0332

π

┌

┐

┌

┐

┌

┐



H

u

┌

┐

┌

┐

┌

┐

tildesubnosp

0330

enquad

2000

emquad

2001

enspace

2002

┌

┐

┌

┐

┌

┐

┌

┐

┌

┐

┌

┐

┌

┐

┌

┐

┌

┐

┌

┐

┌

┐

┌

┐

emspace

2003

thirdemspace

2004

quarteremspace

2005

sixthemspace

2006

┌

┐

┌

┐

┌

┐

┌

┐

┌

┐

┌

┐

┌

┐

┌

┐

figurespace

2007

punctuationspace

2008

thinspace

2009

hairspace

200A

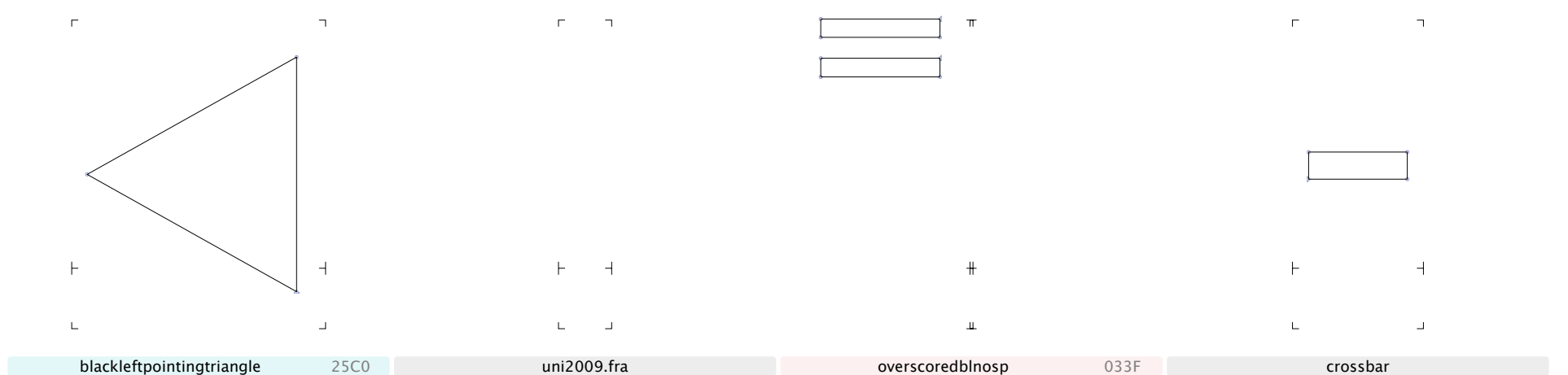
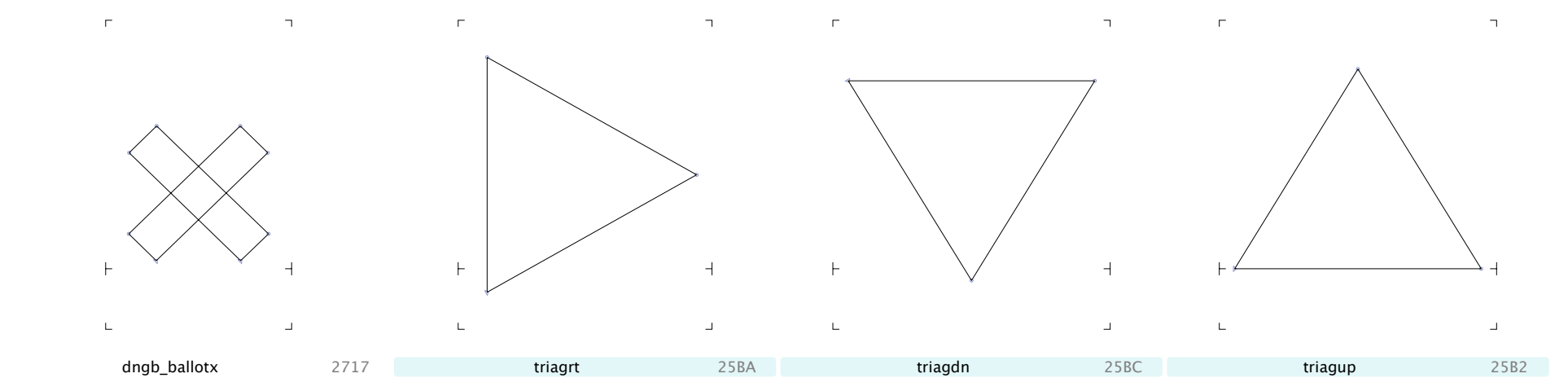
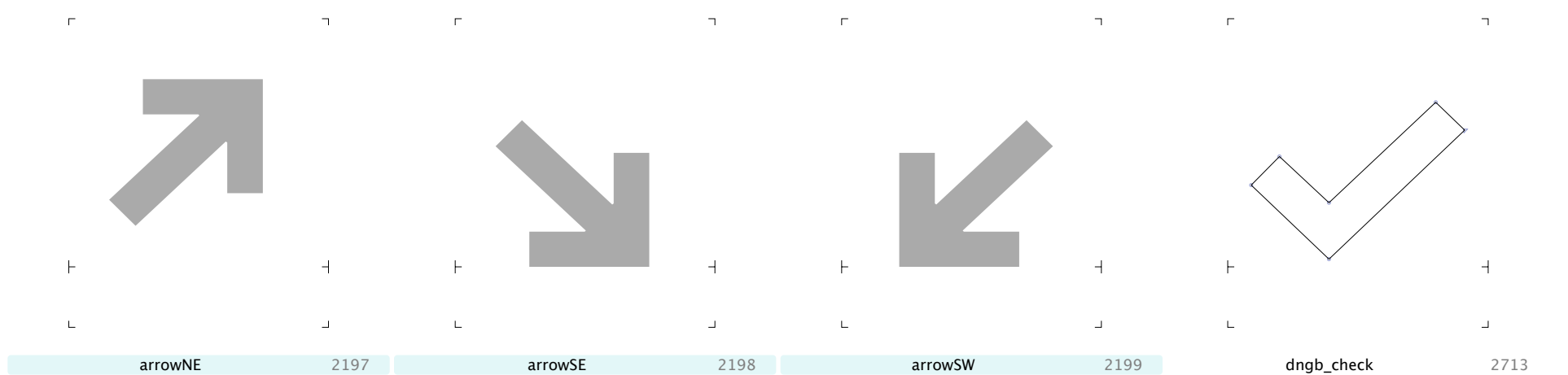
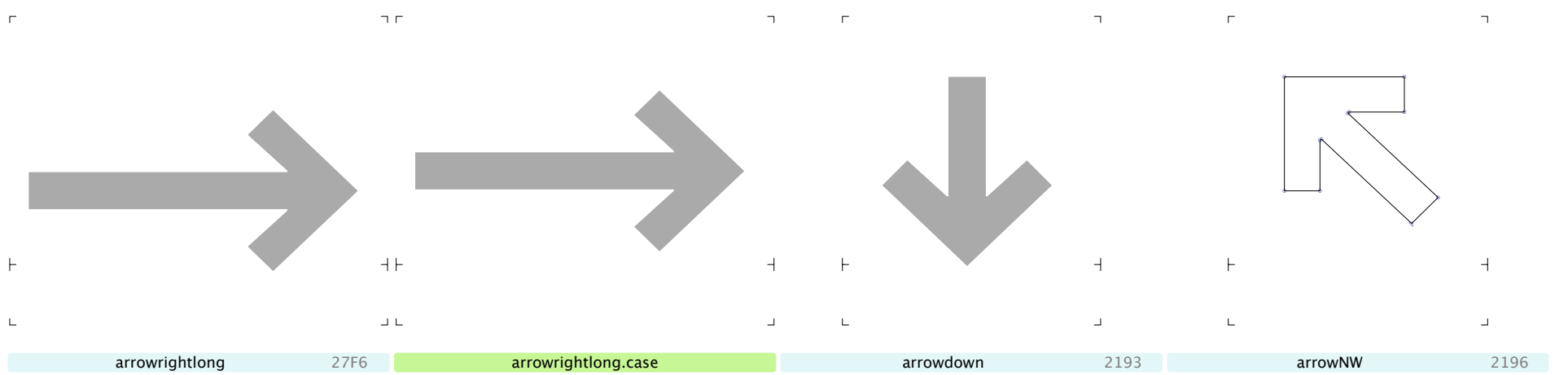
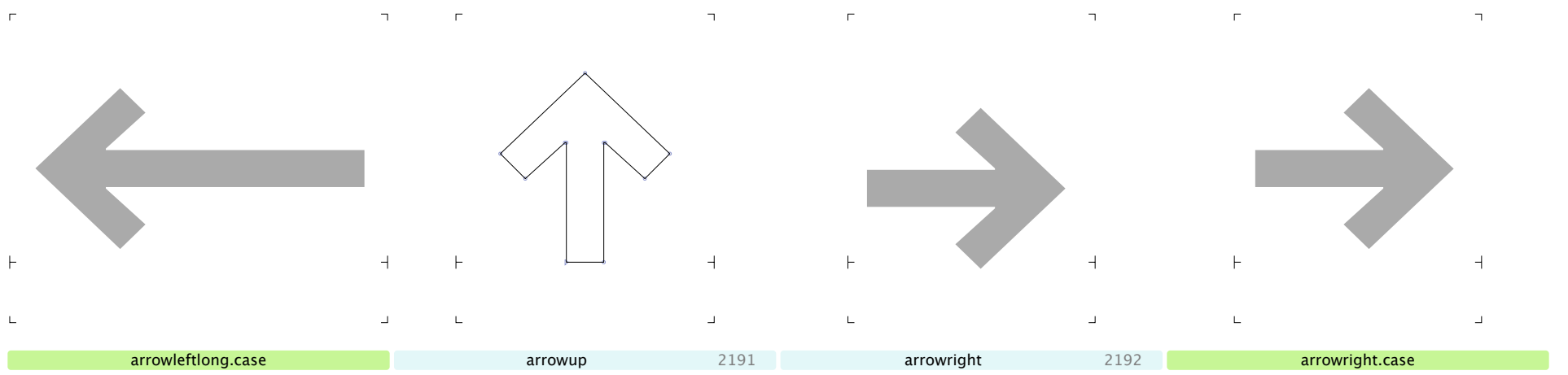
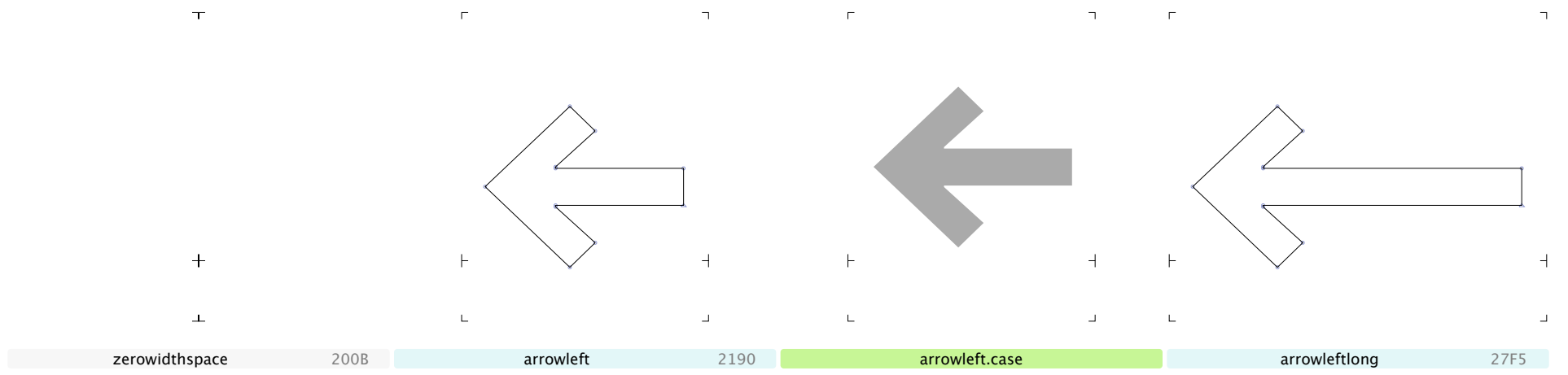

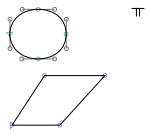

π

#

⊥

acutedotcomb.lc

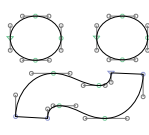

π

#

⊥

tildedieresiscomb.lc

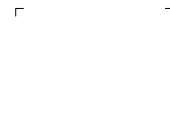

#

underscoredbl

2017



#

romanone

2160

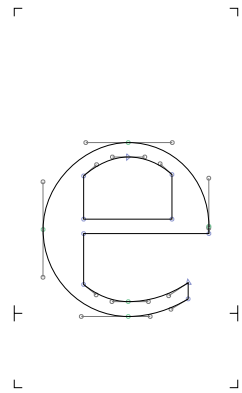

estimated

212E

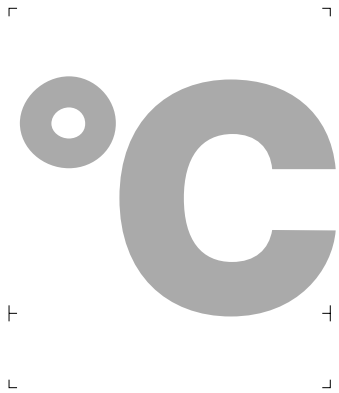

degreecentigrade

2103



dieresisacutecomb.lc

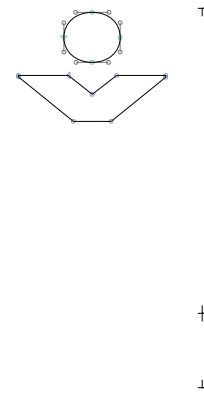

carondotcomb.lc



uni1FFD

1FFD



uni1FFE

1FFE

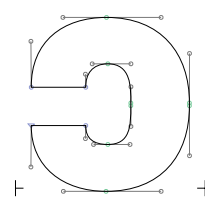

oopen

0254

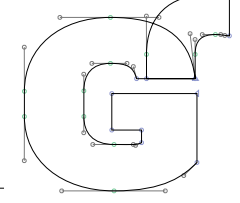

Gsmallcaphook

029B

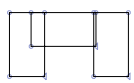

uni0346

0346

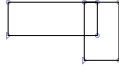

anglesupnosp

031A

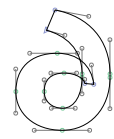

uni1DD8

1DD8

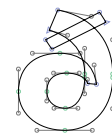

uni1DD9

1DD9

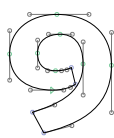

uni1DD2

1DD2

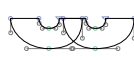

uni1DD3

1DD3

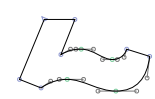

uni1DD0

1DD0

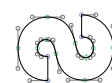

uni1DD1

1DD1

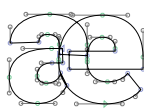

uni1DD4

1DD4

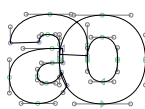

uni1DD5

1DD5

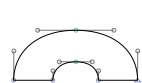

breveinvsubnosp

032F



commaturnsupnosp

0312

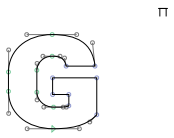

uni1DDB 1DDB

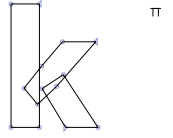

uni1DDC 1DDC



ringrighthalfsubnosp 0339

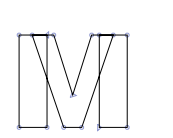

uni1DDF 1DDF

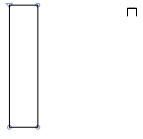

uni1DDD 1DDD

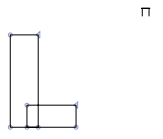

uni1DDE 1DDE



romanten 2169



degreefarenheit 2109



degreekelvin 212A

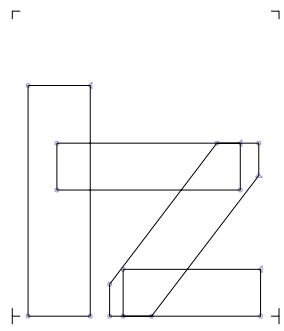

uni02AB 02AB

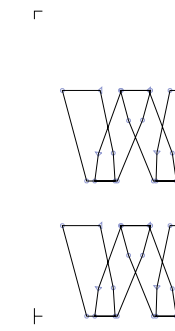

uni02AC 02AC

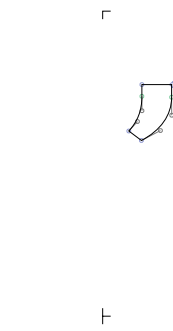

uni1FCD 1FCD

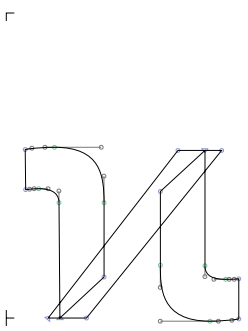

kappa1 03F0

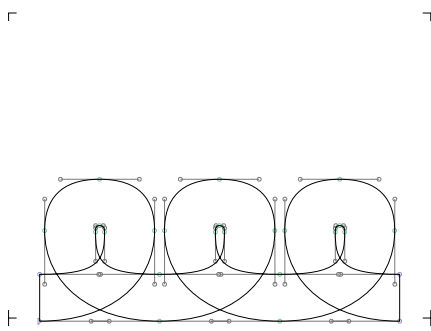

uni214F 214F

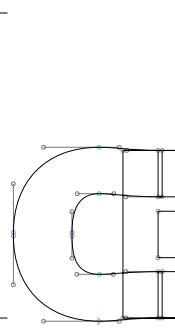

OESmallcap 0276



tackupsubnosp 031D

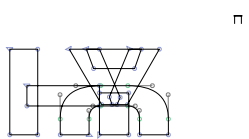

uni2DFF 2DFF

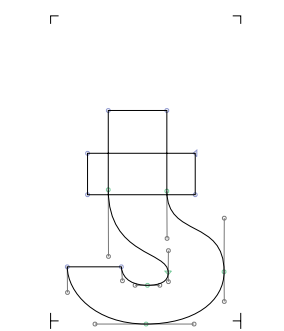

glottalstopbarinv 01BE



seagullsubnosp 033C



uni02EC 02EC

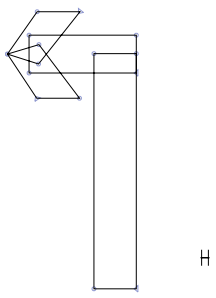

afi300 200F

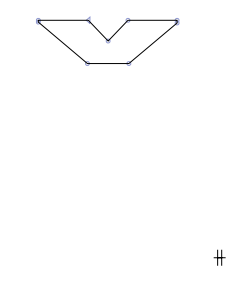

caronnosp



romanfour 2163

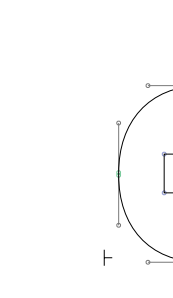

uni03F5 03F5

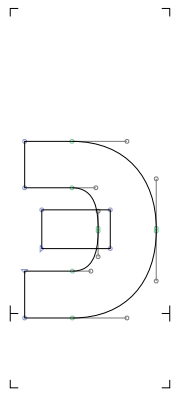

uni03F6 03F6

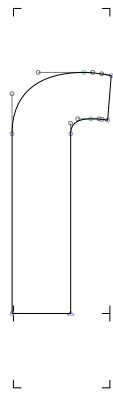

longs 017F

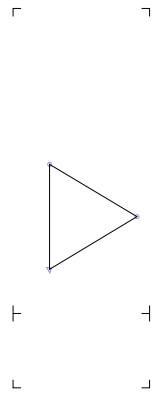

trianglebullet 2023

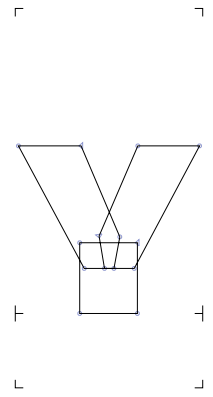

Ysmallcap 028F

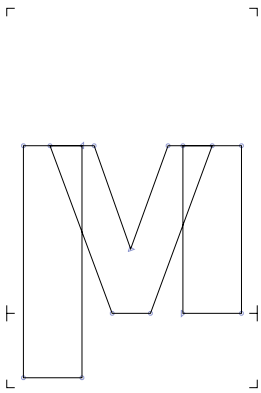

uni03FB 03FB

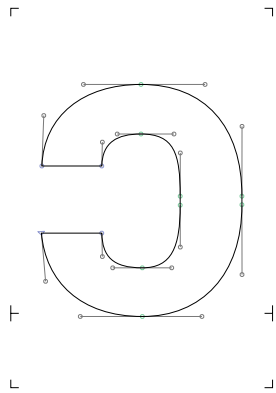

uni03FD 03FD



uni03FE 03FE

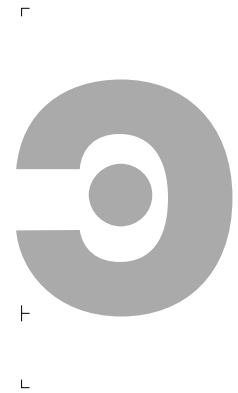

uni03FF 03FF

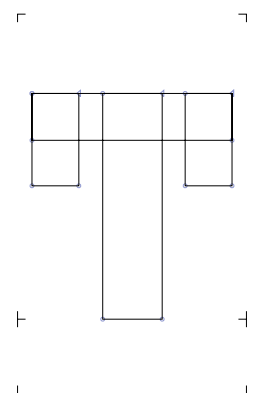

uni0373 0373

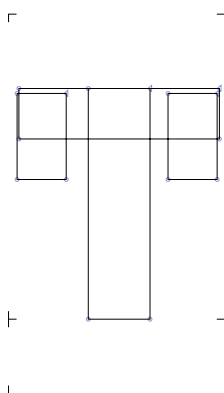

uni0372 0372

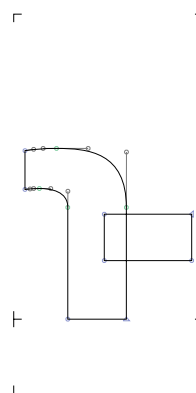

uni0371 0371

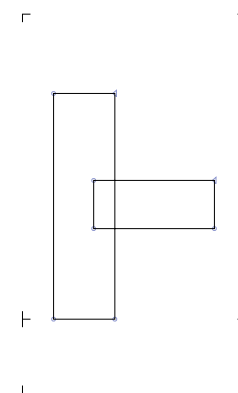

uni0370 0370

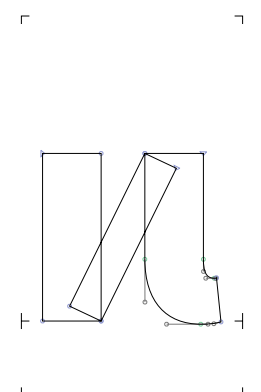

uni0377 0377

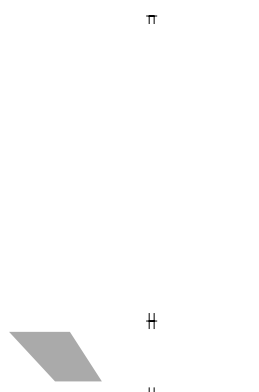

gravesubnosp 0316



undertie 203F

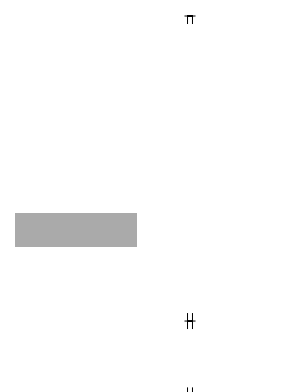

barmidshortnosp 0335

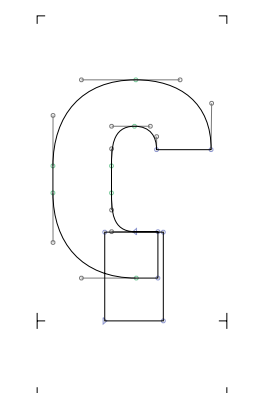

glottalstoprevinv 0295

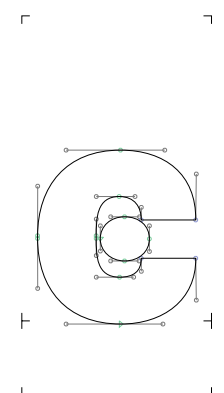

uni037C 037C

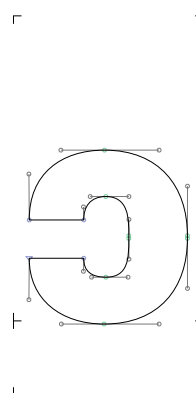

uni037B 037B

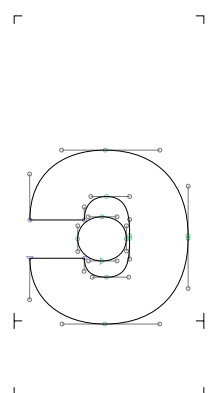

uni037D 037D

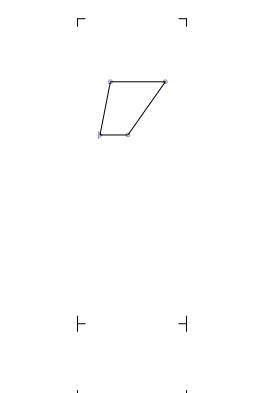

primemod 0289



uni213B 213B

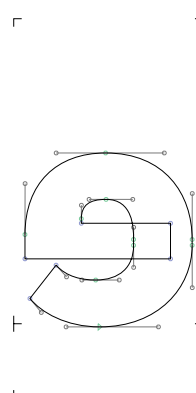

erev 0258

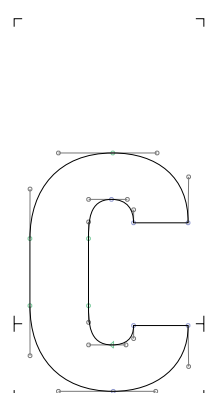

cstretch 0297



Btopbar

0182

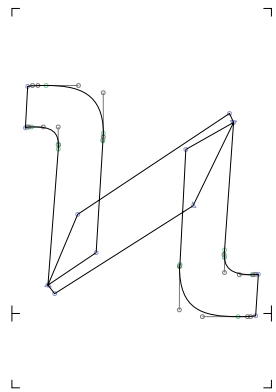

Koppa

03DE

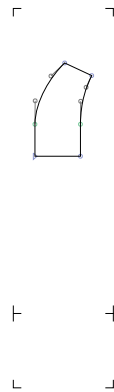

commaturnedmod

02BB



commareversedmod

02BD



ringhalfleft

02BF

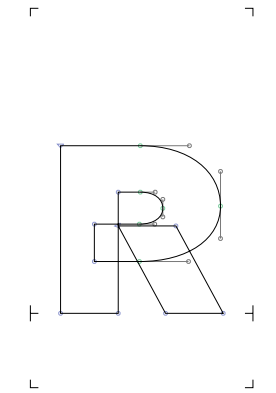

Rsmallcap

0280

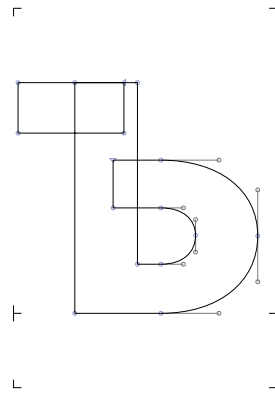

Tonesix

0184

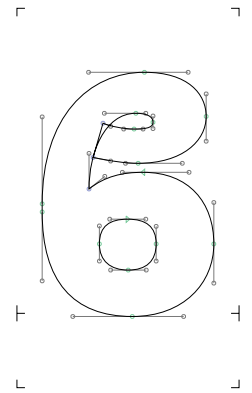

beta1

03D0



uni204F

204F

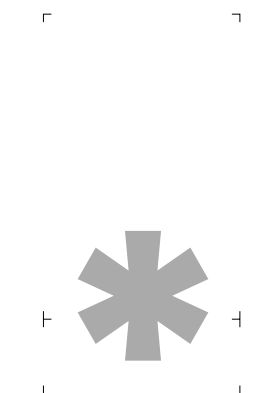

uni204E

204E

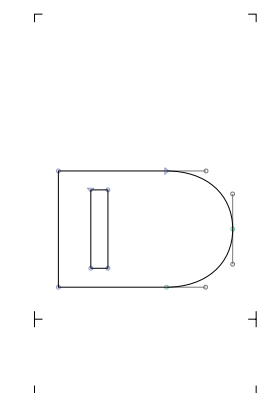

uni204D

204D

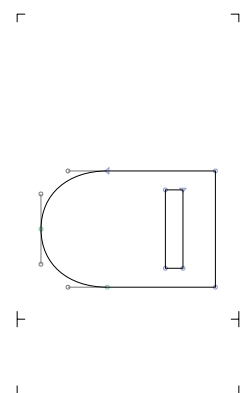

uni204C

204C

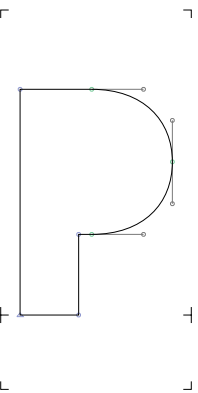

uni204B

204B

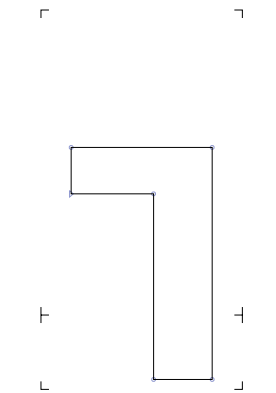

uni204A

204A

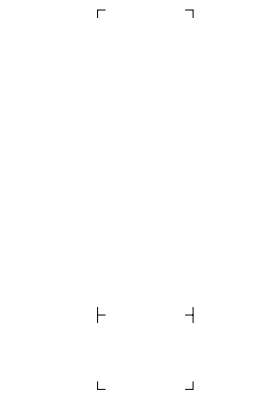

CR

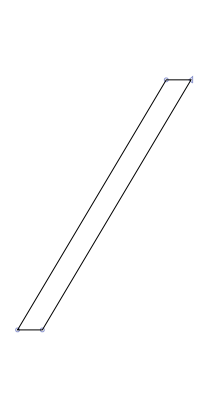

slashlongnosp

0338



exclam1

01C3

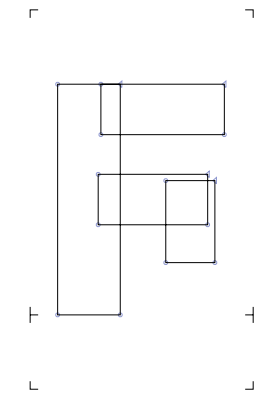

Digamma

03DC



candrabindunosp

0310

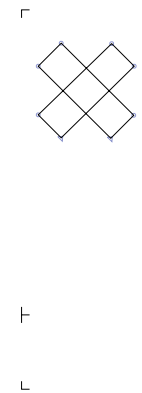

qofdagesh

02DF

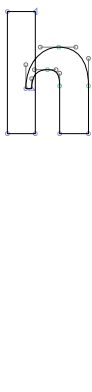

uni036A

036A

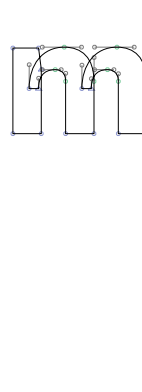

uni036B

036B



uni036C

036C



uni036D

036D

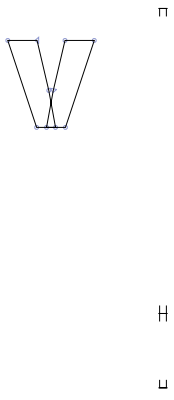

uni036E 036E

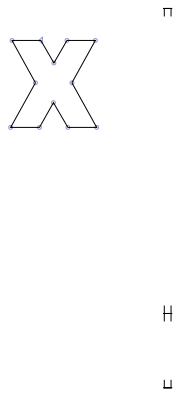

uni036F 036F

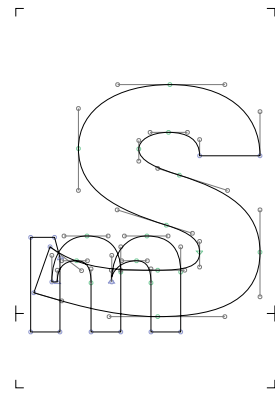

uni20B7 20B7

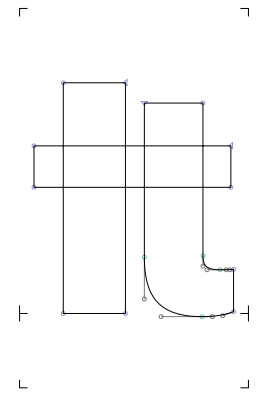

uni20B6 20B6

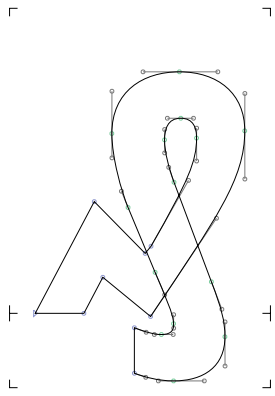

uni20B0 20B0

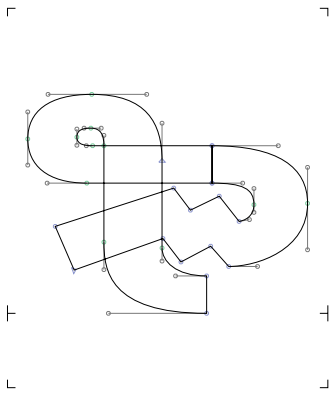

uni20BB 20BB

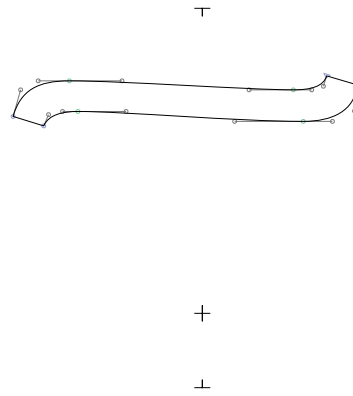

tildedoublecmb 0360

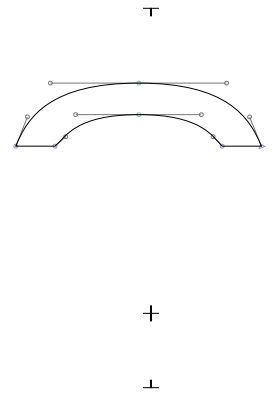

breveinverteddoublecmb 0361

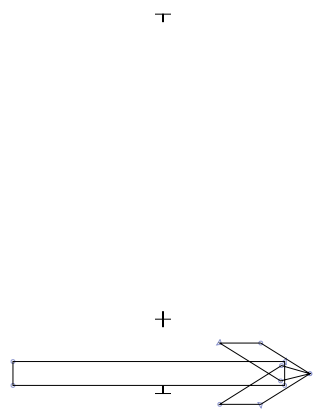

uni0362 0362

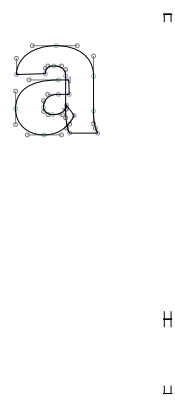

uni0363 0363

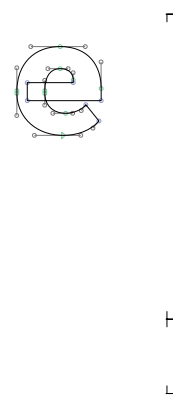

uni0364 0364

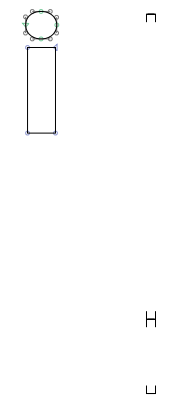

uni0365 0365

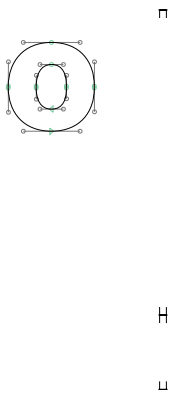

uni0366 0366

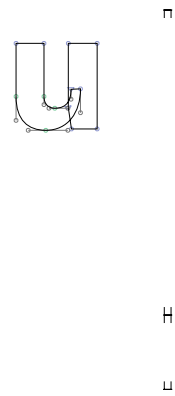

uni0367 0367

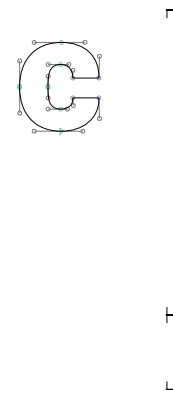

uni0368 0368

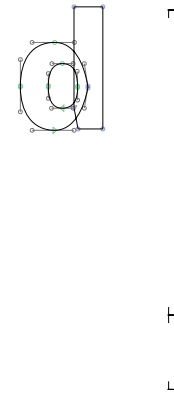

uni0369 0369

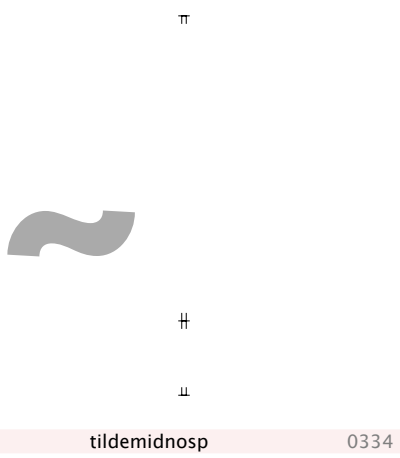

tildemidnosp 0334

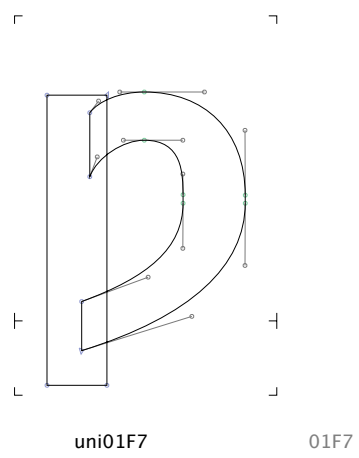

uni01F7 01F7

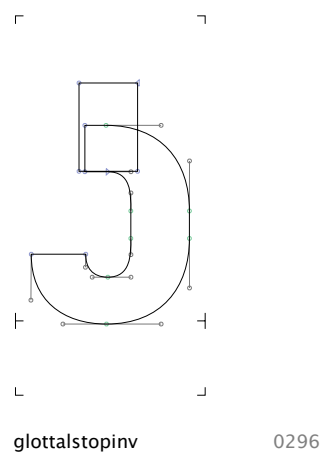

glottalstopinv 0296

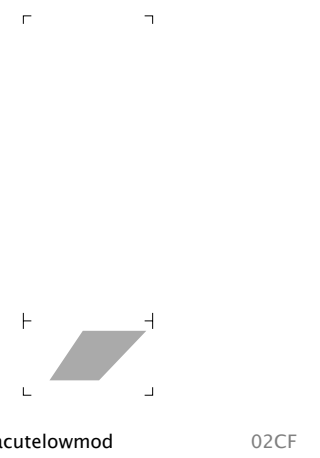

acutelowmod 02CF

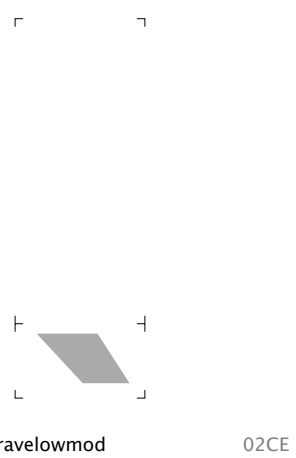

gravelowmod 02CE

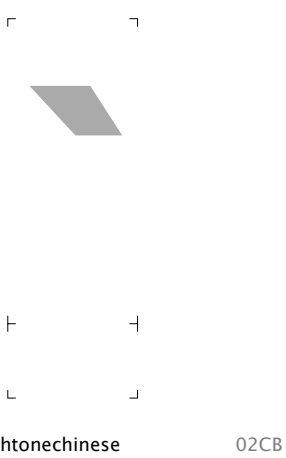

fourthtonechinese 02CB

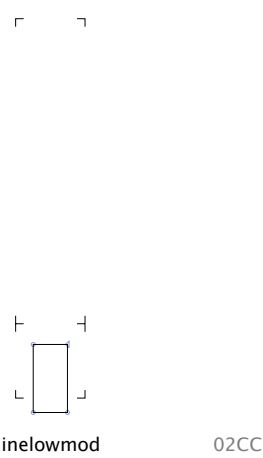

verticallinelowmod 02CC

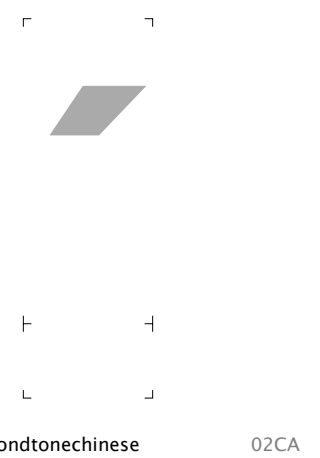

secondtonechinese 02CA



romantwelve 216B

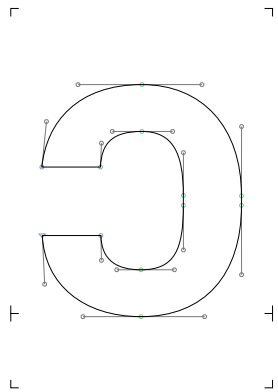

uni2183 2183

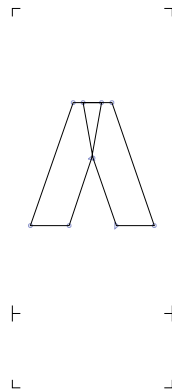

arrowheadupmod 02C4

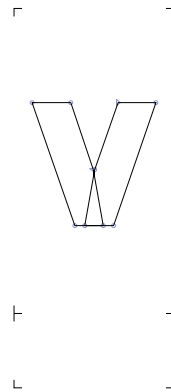

arrowheaddownmod 02C5

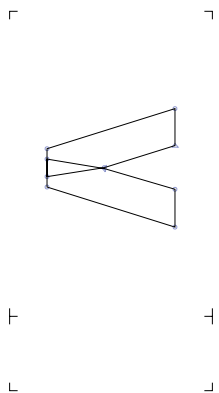

arrowheadleftmod 02C2

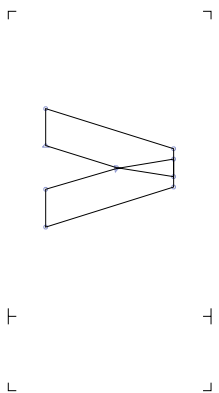

arrowheadrightmod 02C3

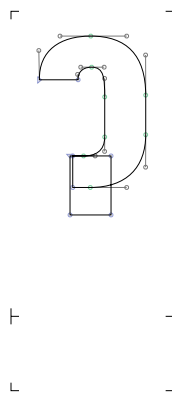

glottalstopmod 02C0



firststonechinese 02C9

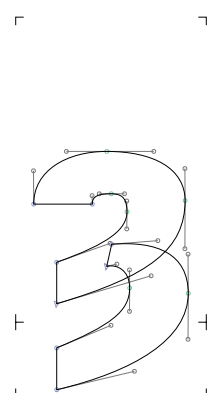

uni021D 021D



uni0268.ccmp

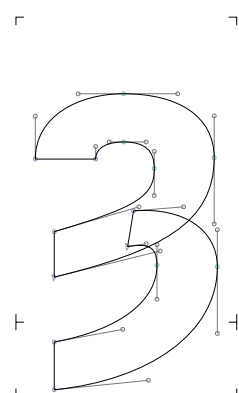

uni021C 021C



numeralgreeksub 0375



caronsubnosp



uni205E 205E



uni205A 205A

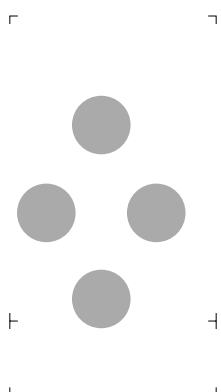

uni205B 205B

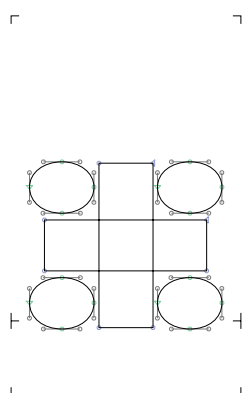

uni205C 205C

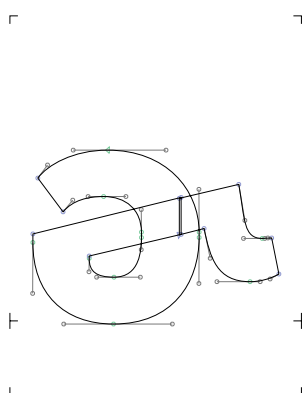

schwahook 025A

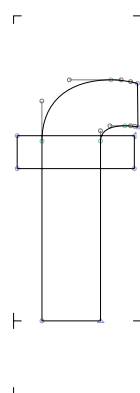

uni1E9D 1E9D



uni1E9F 1E9F

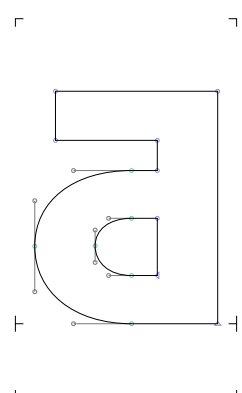

Dtopbar 018B

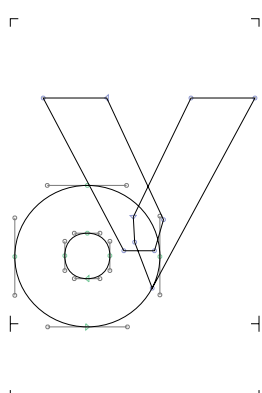

uni1EFE 1EFE

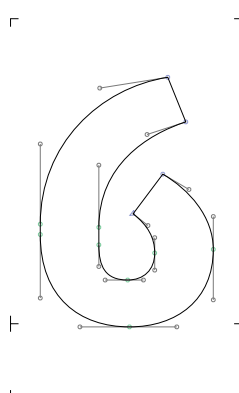

uni1EFD 1EFD

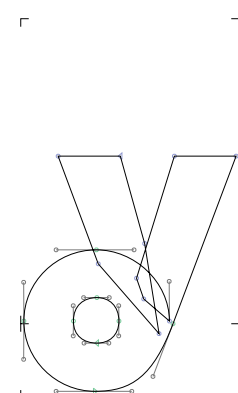

uni1EFF 1EFF

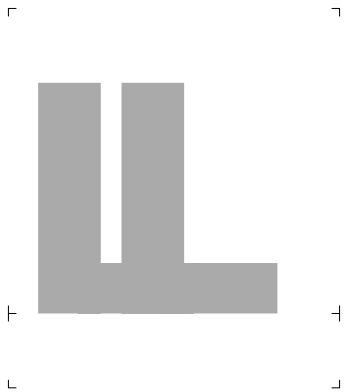

uni1EFA

1EFA

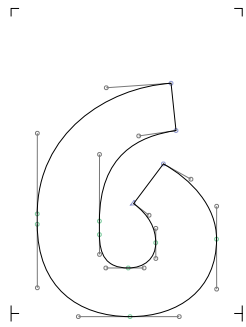

uni1EFC

1EFC

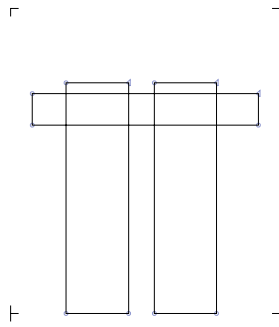

uni1EFB

1EFB

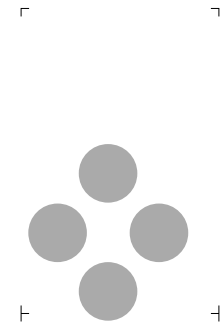

uni2058

2058

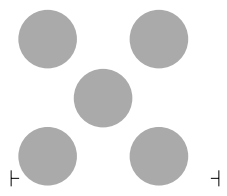

uni2059

2059

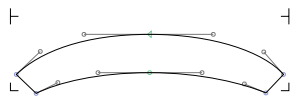

uni2054

2054

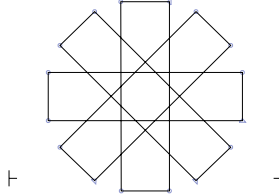

uni2055

2055

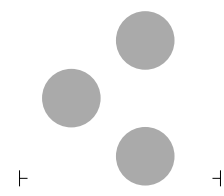

uni2056

2056

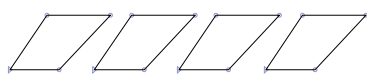

uni2057

2057

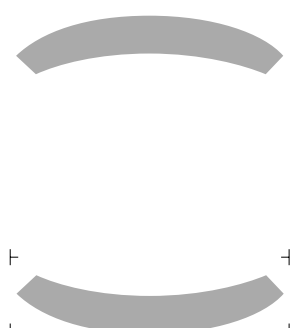

uni2050

2050

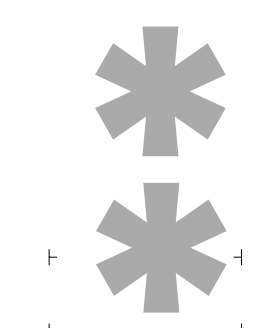

uni2051

2051

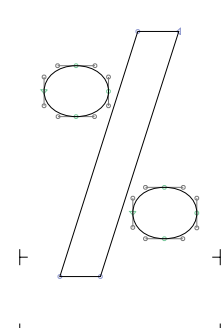

uni2052

2052

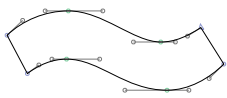

uni2053

2053



ascript_uni02DE

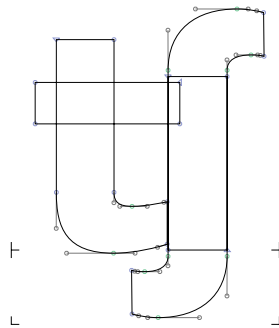

tesh

02A7

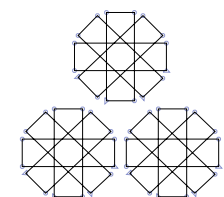

asterism

2042

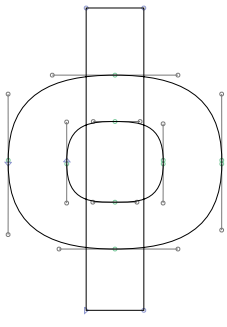

philatin

0278



sixroman

2175

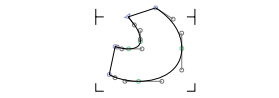

cyrillichookleft

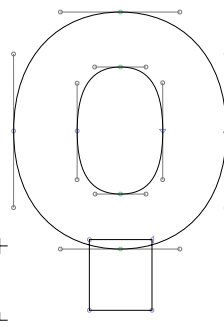

uni03D8

03D8

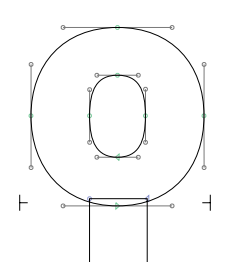

uni03D9

03D9

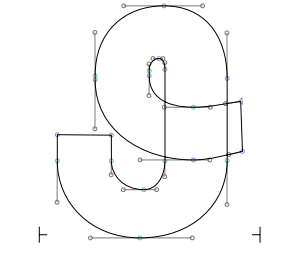

thetasymbolgreek

03D1

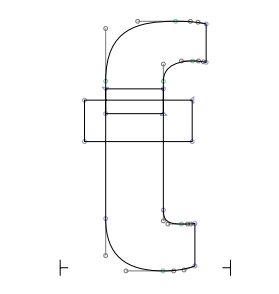

thook

01AD

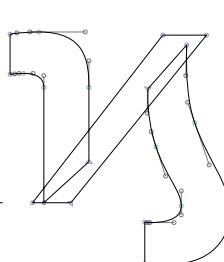

uni03D7

03D7

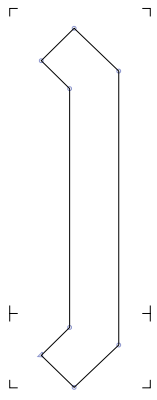

uni27EF 27EF

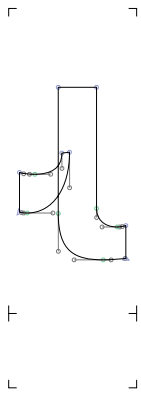

finaltsadi 02B5

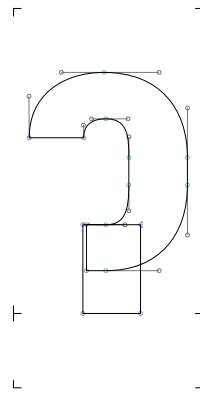

glottalstop 0294



uni0359 0359

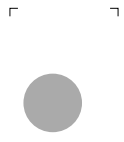

uni0358 0358



uni0355 0355



uni0354 0354



uni0357 0357



uni0356 0356



uni0355 0355



uni0354 0354



uni0357 0357



uni0356 0356



uni0351 0351



uni0350 0350



uni0353 0353



uni0356 0356



uni0351 0351



uni0350 0350



uni0353 0353

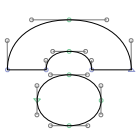

uni0352 0352

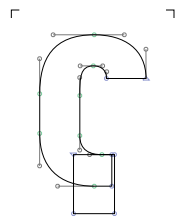

glottalstopreversedmod 02C1

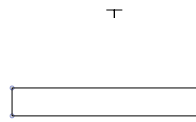

uni035E 035E

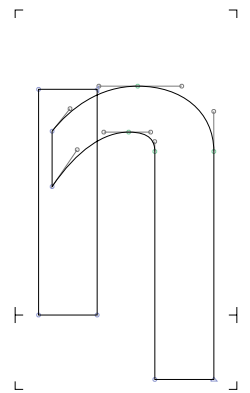

uni0220 0220

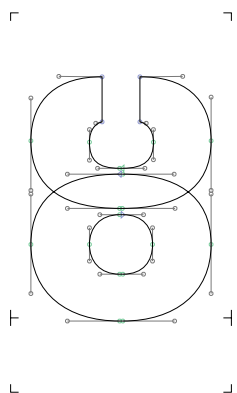

uni0223 0223



uni035F 035F

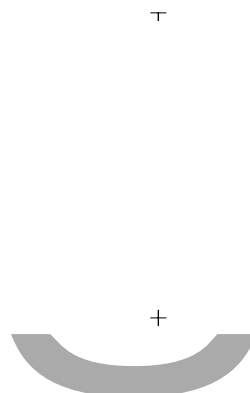

uni035C 035C



uni035B 035B

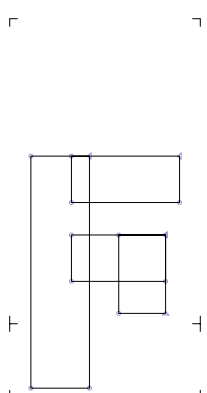

digamma 03DD

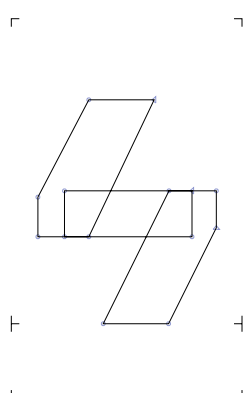

koppa 03DF



ringhalfrightcentered 02D2



colontriangularhalfmod 02D1

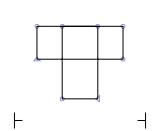
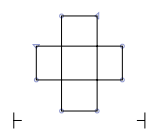
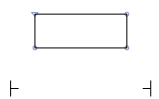
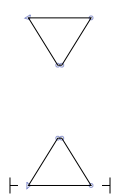

colontriangularmod 02D0

02D0

minusmod 02D7

plusmod 02D6

downtackmod 02D5

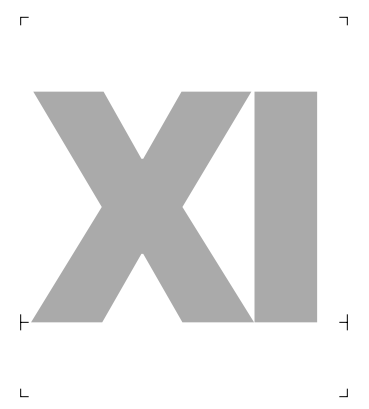
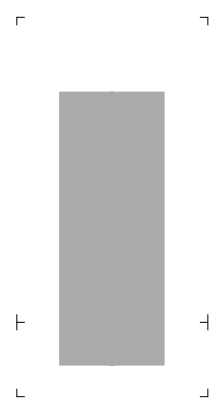
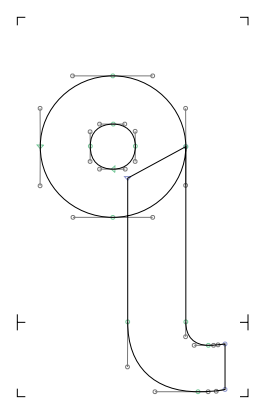

linevertnosp 030D

eshlooprev 01AA

verticalbardbl 2016

romaneleven 216A

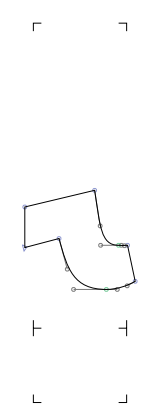
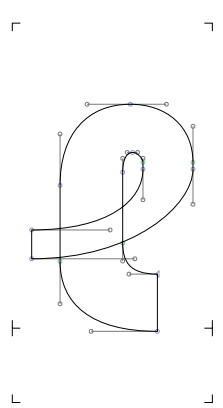
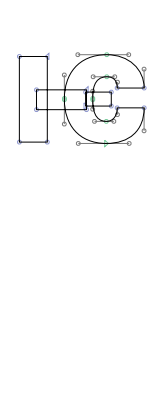
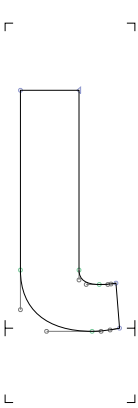

lota1 0196

uniA69F A69F

lsquare 2113

rhotichookmod 02DE

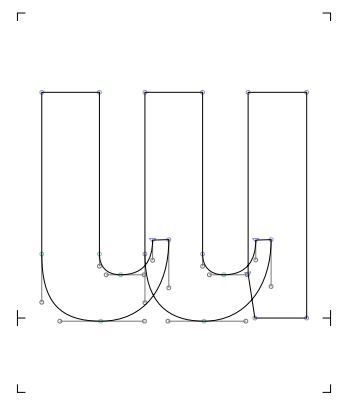
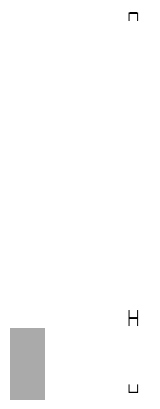
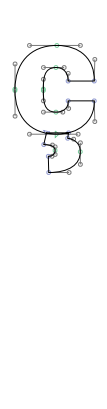
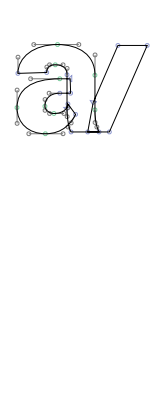

uni1DD6 1DD6

uni1DD7 1DD7

linevertsubnosp 0329

mcapture 019C

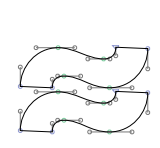
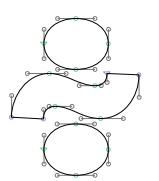
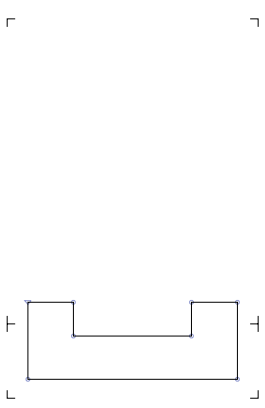
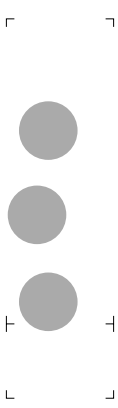

uni205D 205D

spaceopenbox 2423

uni034B 034B

uni034C 034C

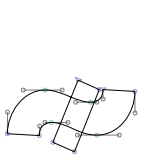

uni034A 034A

uni034F 034F

uni034D 034D

uni034E 034E



uni0348 0348



uni0349 0349

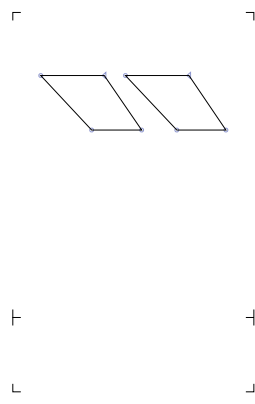

reverseddblprime 2036



perispomenigreekcmb 0342



koroniscmb 0343

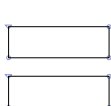

uni0347 0347

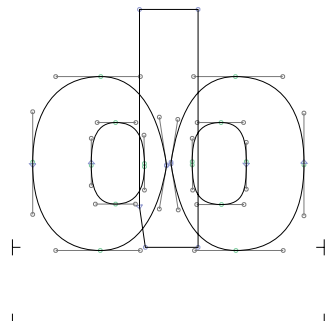

uni0238 0238

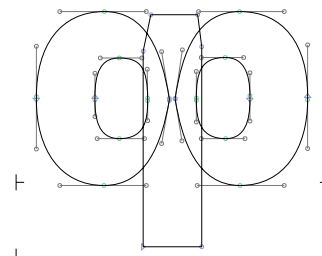

uni0239 0239

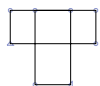

tackdownsubnosp 031E

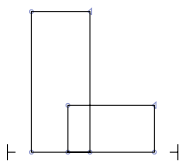

uni02EA 02EA

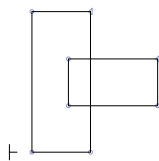

uni02EB 02EB



uni2071.ccmp

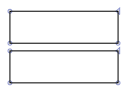

uni02ED 02ED

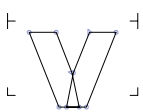

uni02EF 02EF

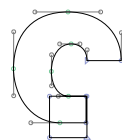

glottalstopreversed.numr 02E4



afi61664 200C

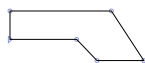

uni1DC6 1DC6

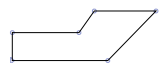

uni1DC4 1DC4

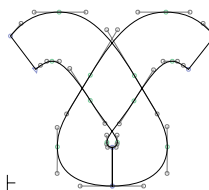

babygamma 0264

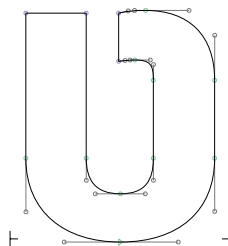

Vcursive 01B2

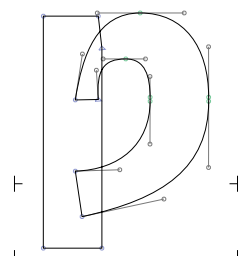

wynn 01BF

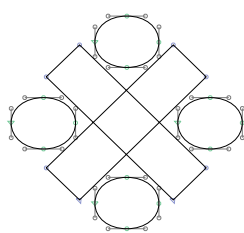

referencemark 203B



overscorenosp 0305

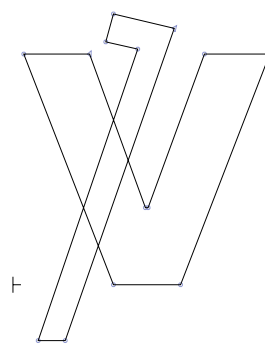

versicle 2123



hyphen_ 2010

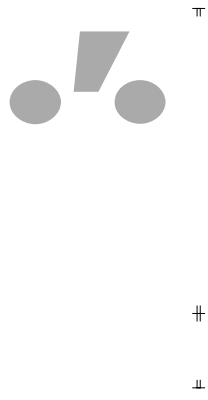

diaeresistonosp 0344

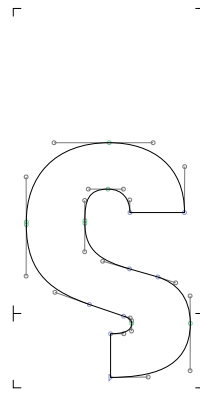

stigma 03DB

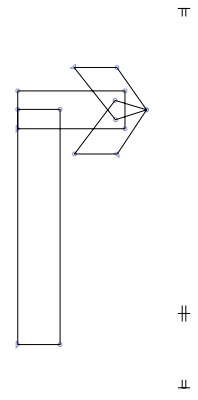

afi57596 200E

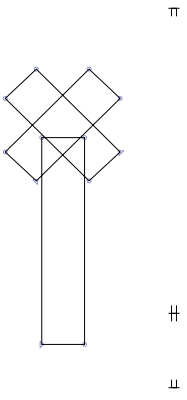

afi57598 200D

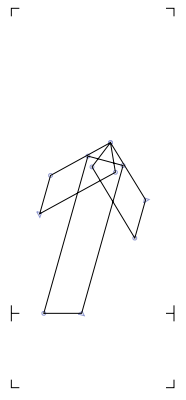

uni2B4E 2B4E

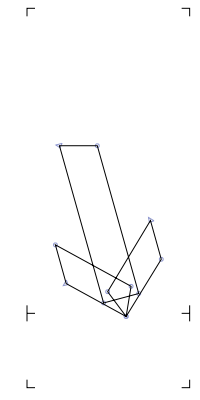

uni2B4F 2B4F

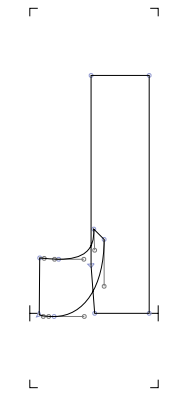

rturnascend 027A



romanfivehundred 216E

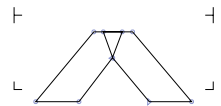

caret 2038

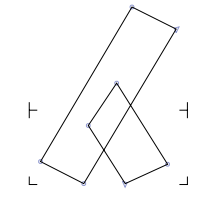

caretinsertionpoint 2041

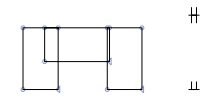

bridgesubnosp 032A

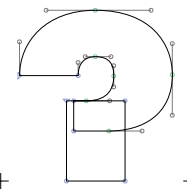

uni0242 0242

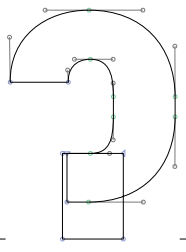

uni0241 0241

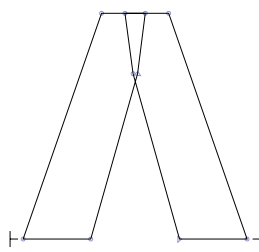

uni0245 0245



uni02F9 02F9



uni02F8 02F8



uni02F5 02F5



uni02F4 02F4

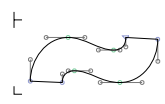

uni02F7 02F7



uni02F6 02F6

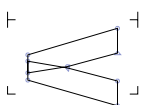

uni02F1 02F1

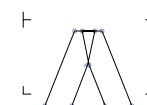

uni02F0 02F0

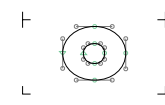

uni02F3 02F3

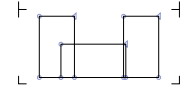
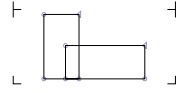
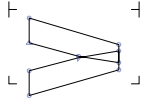
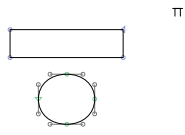

uni02F2

02F2

dotmacroncomb.lc

uni02FE

02FE

uni02FD

02FD

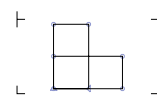
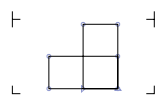
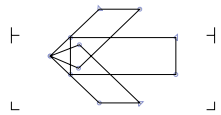

uni02FF

02FF

uni02FA

02FA

uni02FC

02FC

uni02FB

02FB

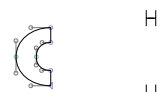
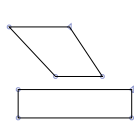
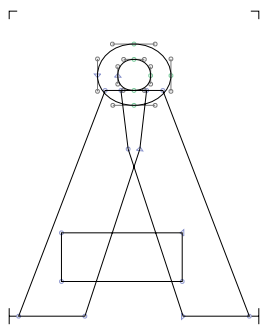

angstrom

212B

macrongravcomb.lc

macronsubnosp

0331

ringlefthalfsubnosp

031C

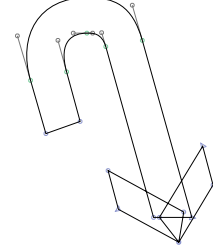
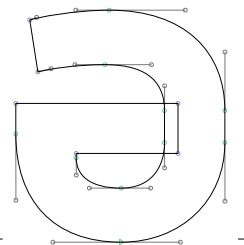
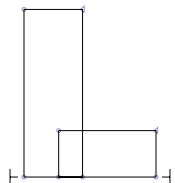

Lsmallcap

029F

squaresubnosp

033B

Schwa

018F

uni2B5B

2B5B

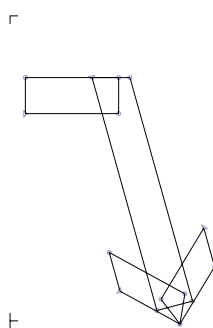
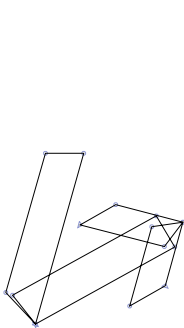
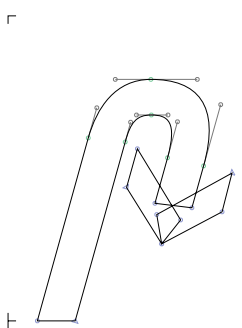
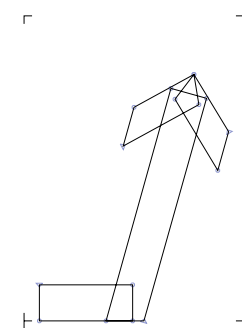

uni2B5C

2B5C

uni2B5A

2B5A

uni2B5F

2B5F

uni2B5D

2B5D

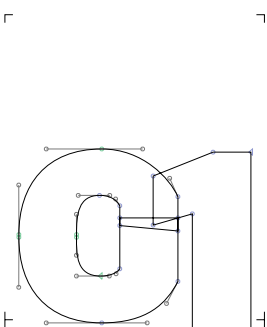
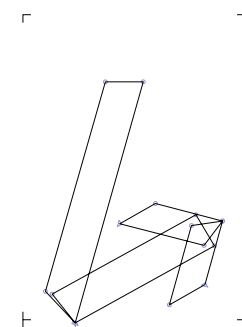

oi

01A3

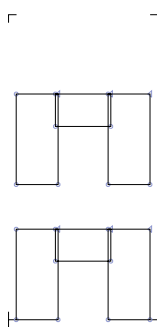

finalmem

02AD

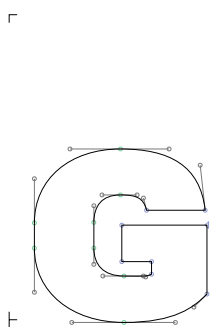

Gsmallcap

0262

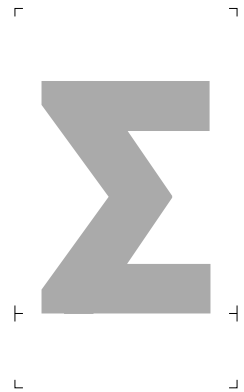

Esh

01A9

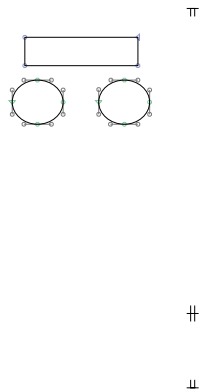

dieresismacroncomb.lc

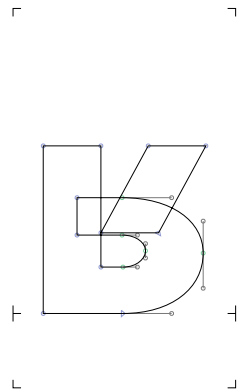

Rsmallcapiv

0281

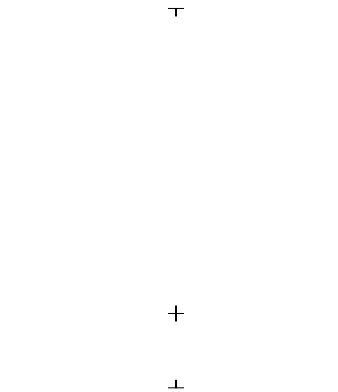

zerowidthjoiner

FEFF

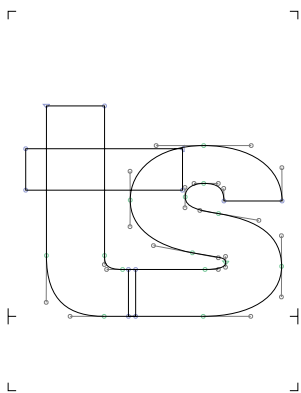

ts

02A6

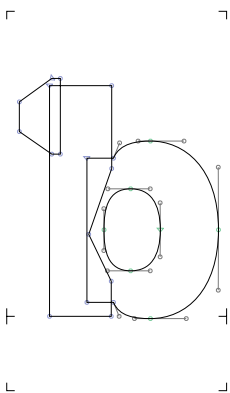

tonesix

0185

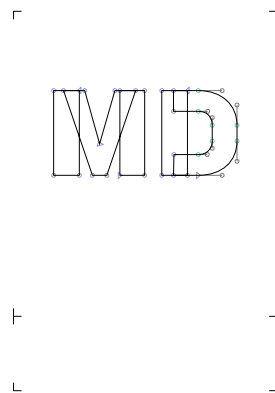

uni1F16B

1F16B

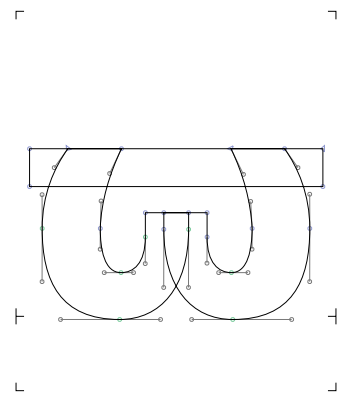

pisymbolgreek

03D6

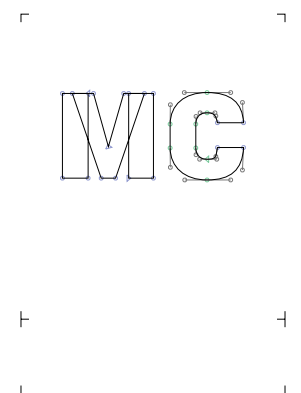

uni1F16A

1F16A

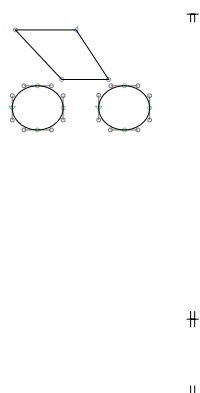

dieresisgravcomb.lc

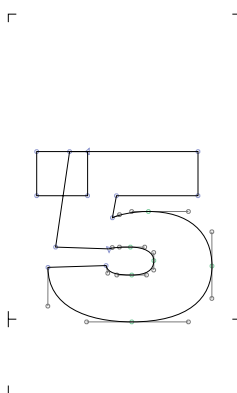

tonefive

01BD

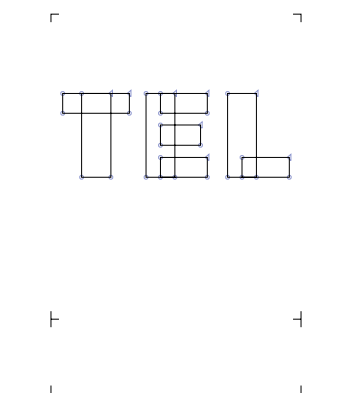

tel

2121

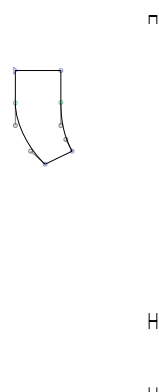

commasuprevnosp

0314



hyphennobreak

2011



archdblsubnosp

032B

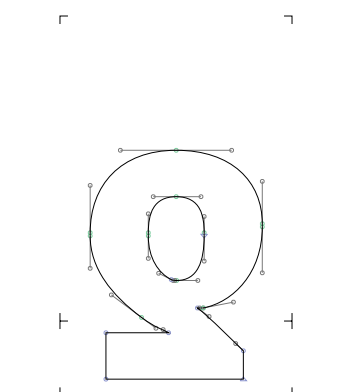

deltaturn

018D

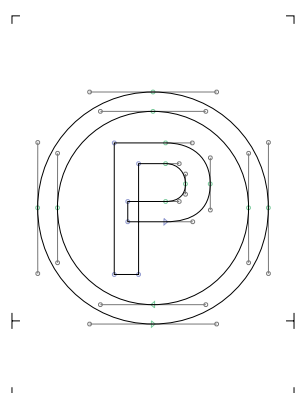

published

2117

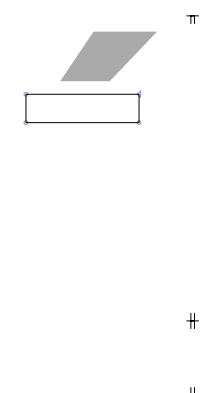

macronacutecomb.lc

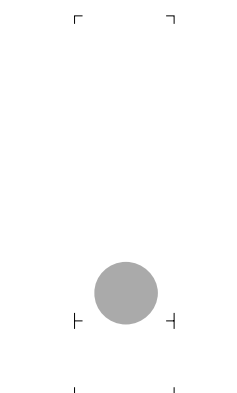

onedotleader

2024

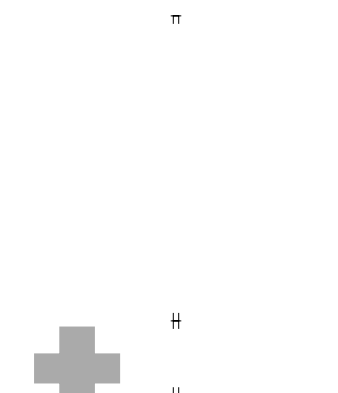

plus.dnomnosp

031F

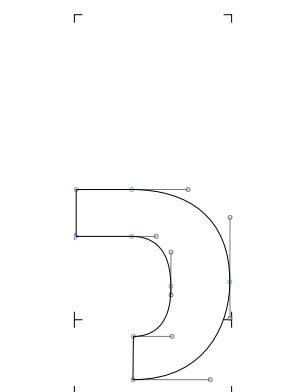

largerighthook



romanthree

2162

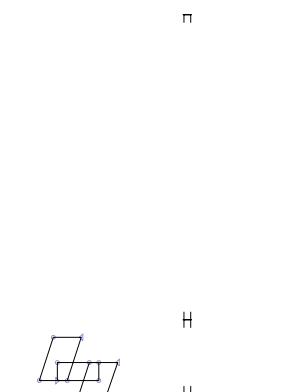

uni1DCF

1DCF



uni1DCE

1DCE

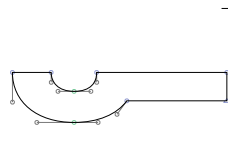
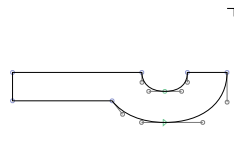
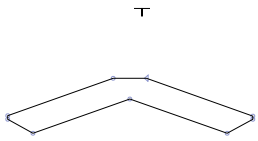

uni1DCD 1DCD

uni1DCC 1DCC

uni1DCB 1DCB

uni1DCA 1DCA

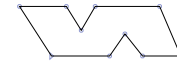
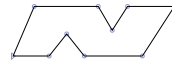
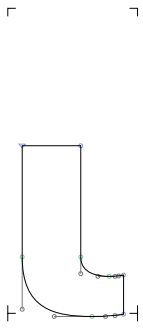
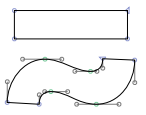

tildemacroncomb.lc

iota1 0269

uni1DC9 1DC9

uni1DC8 1DC8

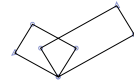
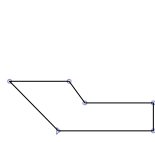
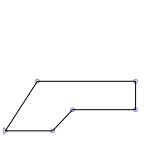

uni1DC7 1DC7

uni1DC5 1DC5

uni1DC3 1DC3

uni1DC2 1DC2

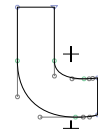
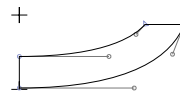
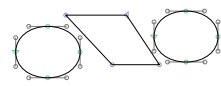
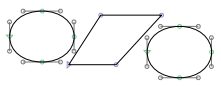

uni1DC1 1DC1

uni1DC0 1DC0

uniFE28 FE28

hooksubretronosp 0322

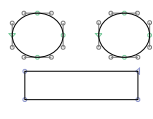
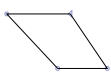

primerev1 2035

macrondieresiscomb.lc

romannine 2168

uni1FBD 1FBD

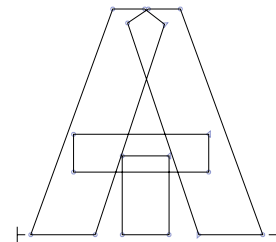
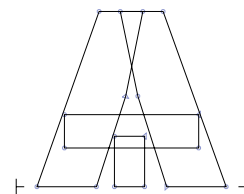
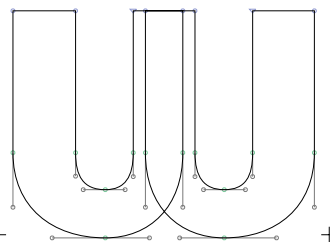
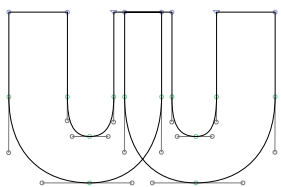

omegacyrillic 0461

Omegacyrillic 0460

yuslitlecyrillic 0467

Yuslitlecyrillic 0466

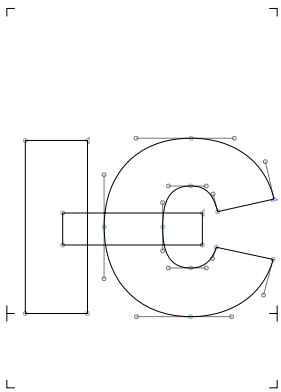

eiotifiedcyrillic 0465

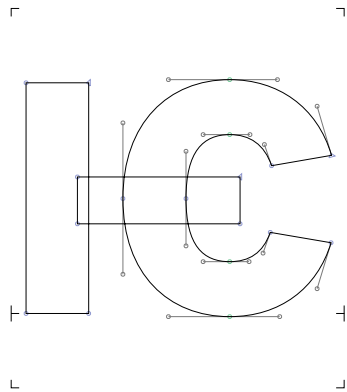

Eiotifiedcyrillic 0464

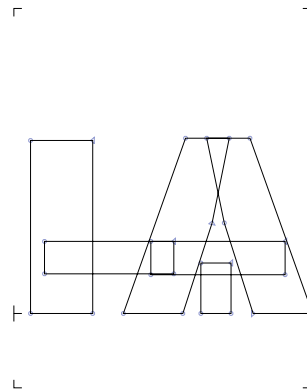

yuslittleiotifiedcyrillic 0469

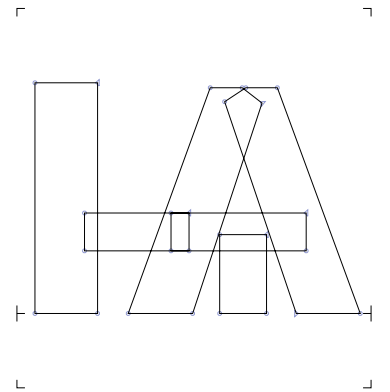

Yuslittleiotifiedcyrillic 0468

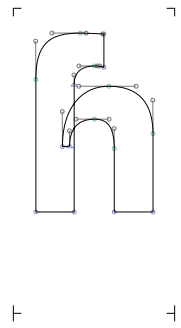

hhooksuper 02B1

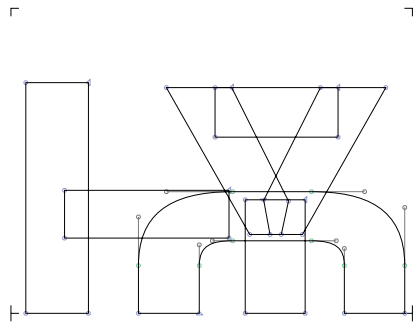

Yusbigiotifiedcyrillic 046C

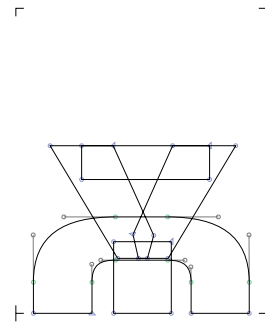

yusbigcyrillic 046B

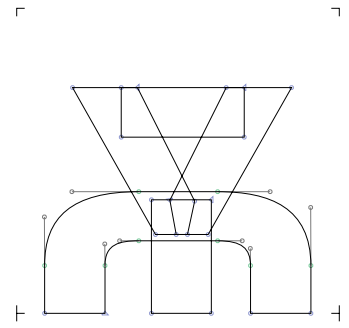

Yusbigcyrillic 046A

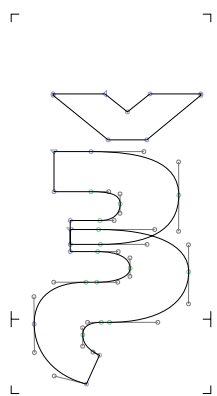

ksicyrillic 046F

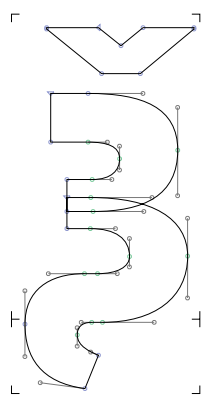

Ksicyrillic 046E

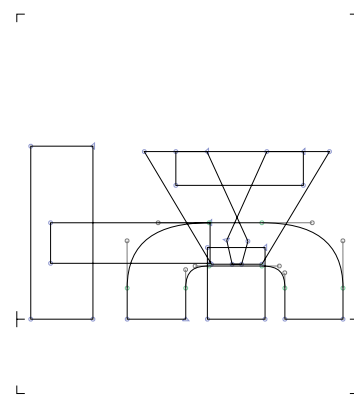

yusbigiotifiedcyrillic 046D



tildeacutecomb.lc



romanthousand 216F



macronsub 02CD



bullseye 0298

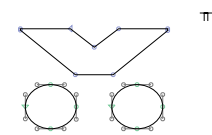

dieresiscaroncomb.lc

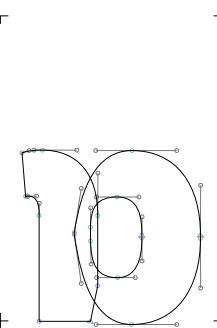

ascriptturn 0252

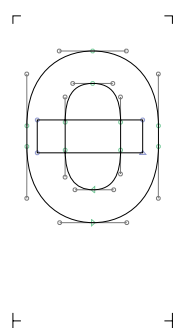

uni1DBF 1DBF



glottalstopbarrev 02A2



cyrillichook

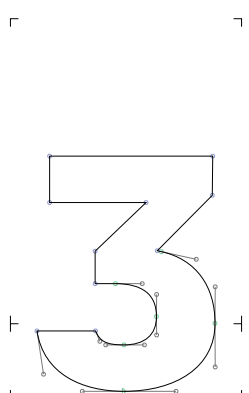

ezh 0292

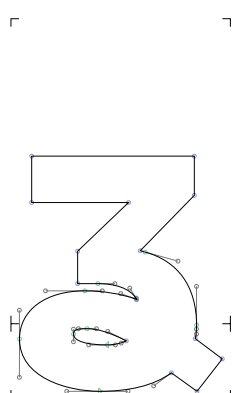

ezhcurl 0293

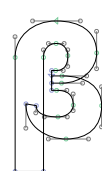

uni1DE9 1DE9



numeralgreek 0374

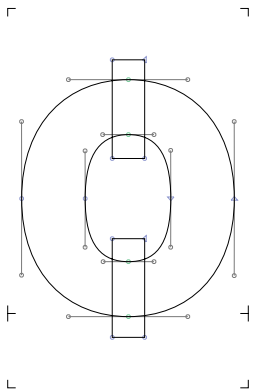

Omegaroundcyrillic 047A

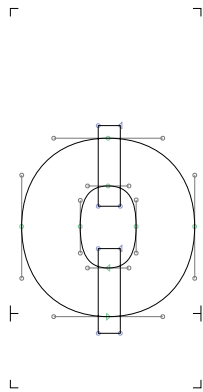

omegaroundcyrillic 047B

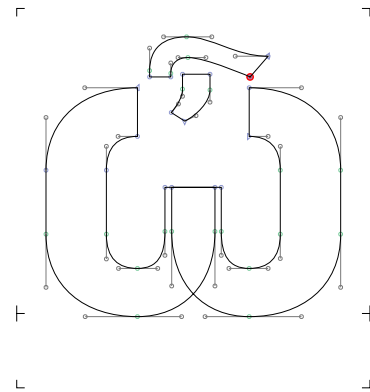

Omegatitlocyrillic 047C

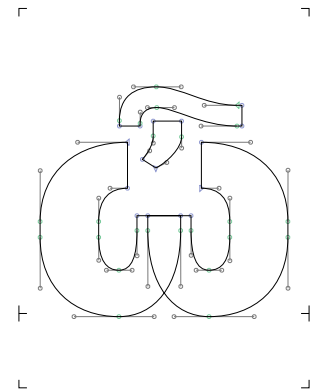

omegatitlocyrillic 047D

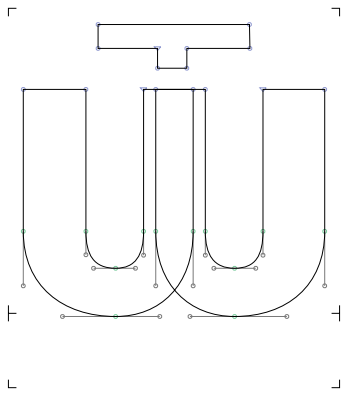

Otcyrillic 047E

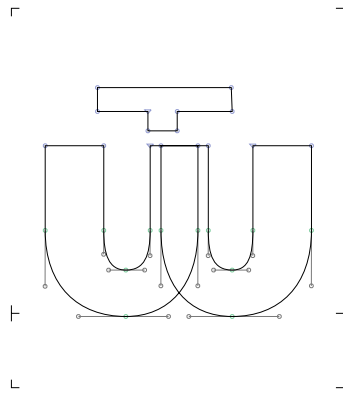

otcyrillic 047F



gcursive 0261

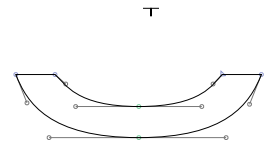

uni035D 035D

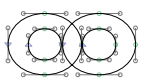

uni035A 035A



quotedblreversed 201F

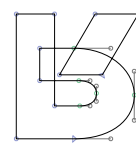

Rturnsuper 02B6

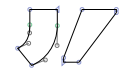

uni1FCE 1FCE

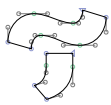

uni1FCF 1FCF

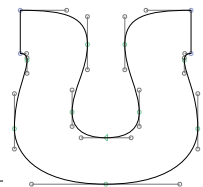

upsilonlatin 028A

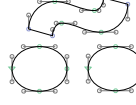

uni1FC1 1FC1



uni1FC0 1FC0



ringhalleftcentered 02D3

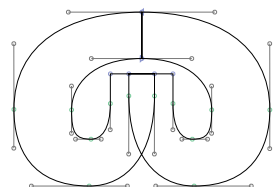

omegaclosed 0277

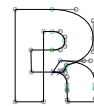

uni1DE2 1DE2

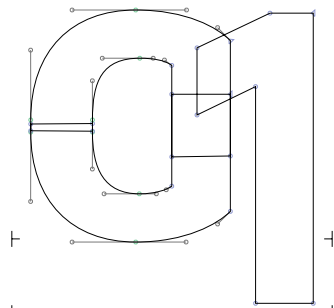

OI 01A2



xsupnosp 033D

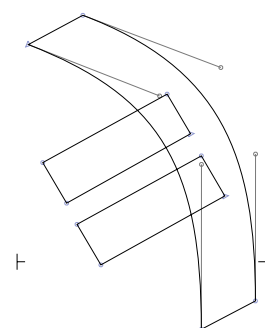

sampi 03E1

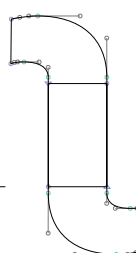

eshshortrev 0285

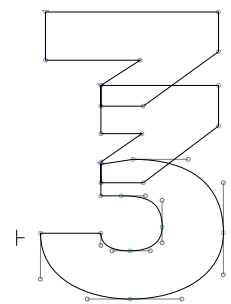

ounce 2125

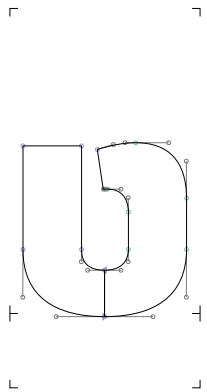

vscript

028B



acuterightnosp

0341

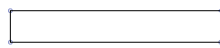

barmidlongnosp

0336

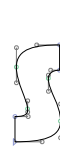

tildevertsupnosp

033E



linevertdblno

030E



jhookdblbar

0284



overline

203E



ascript

0251

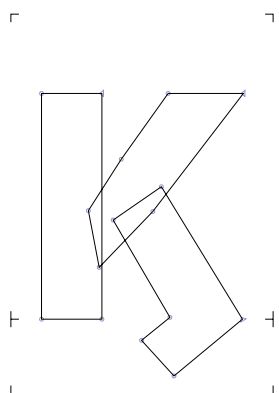

uni03CF

03CF

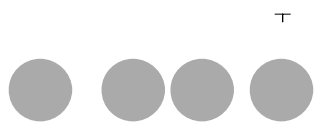

uni20DC

20DC



uni20DB

20DB



romansix

2165

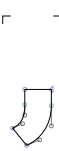

uni1FBF

1FBF



uni1FBE

1FBE



ypogegrameni

037A



romaneight

2167

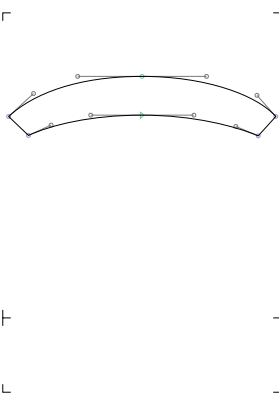

charactertie

2040

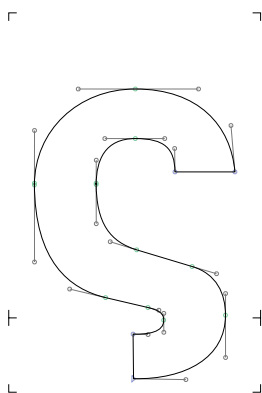

Stigma

03DA

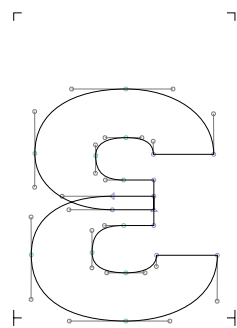

Epsilon1

0190



iotasubnosp

0345



pipedblbar

01C2

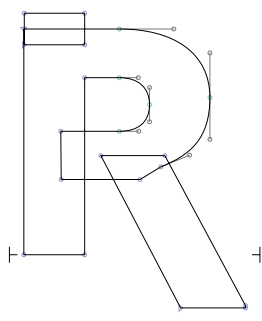

YR

01A6

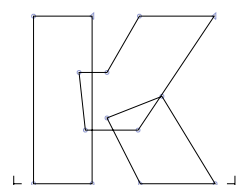

kgreenlandic

0138

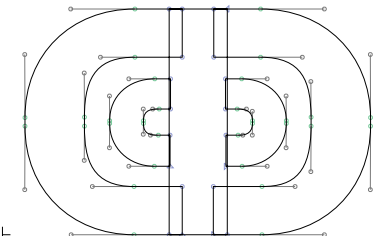

uni2182

2182

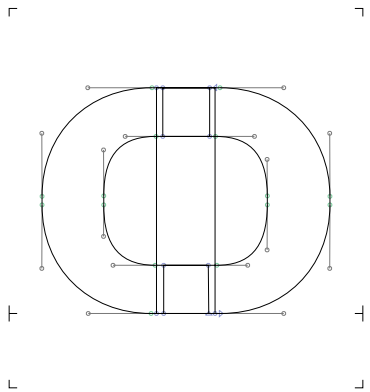

uni2180 2180

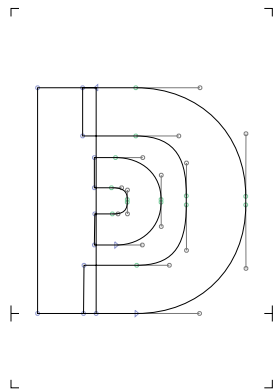

uni2181 2181

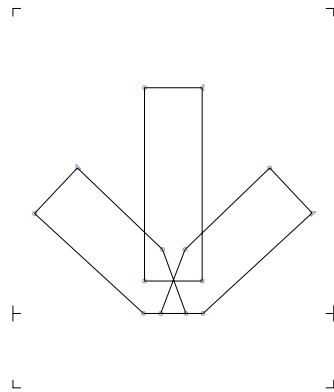

uni2186 2186

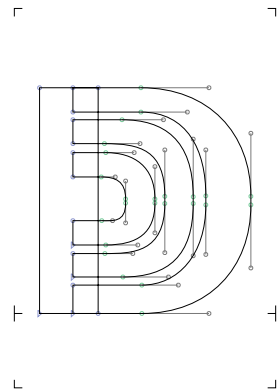

uni2187 2187

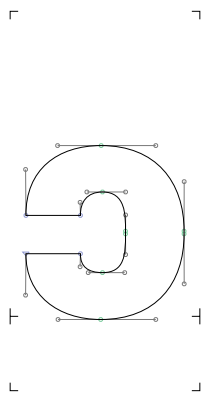

uni2184 2184

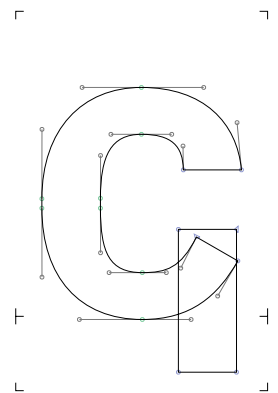

uni2185 2185

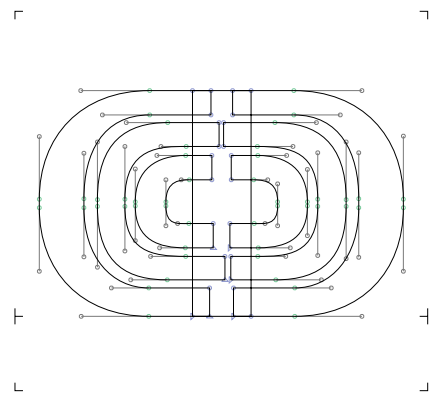

uni2188 2188

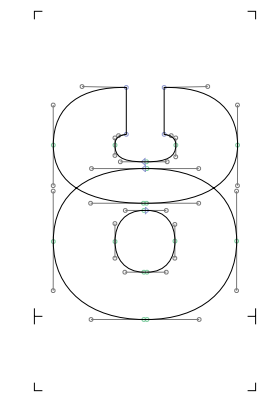

uni0222 0222



romanseven 2166

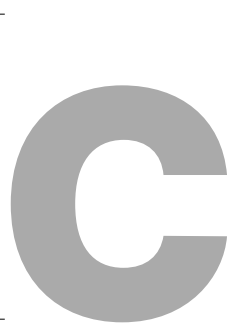

romanhundred 216D

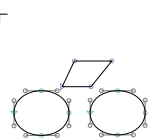

uni1FEE 1FEE

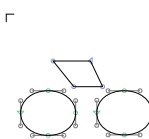

uni1FED 1FED

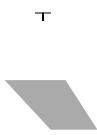

graveleftnosp 0340

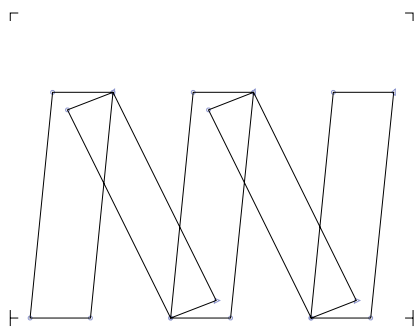

uniA7FF A7FF

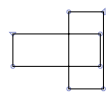

tackleftsubnosp 0318

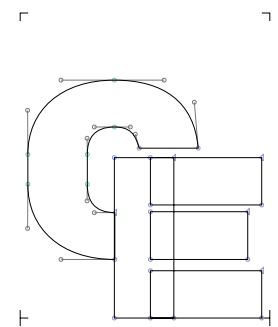

eurocurrency 20A0



uni20E8 20E8

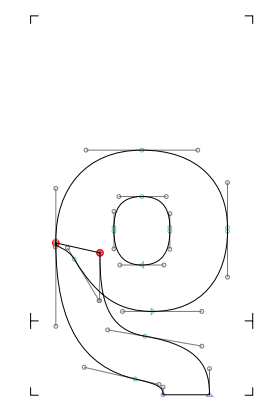

rho1 03F1

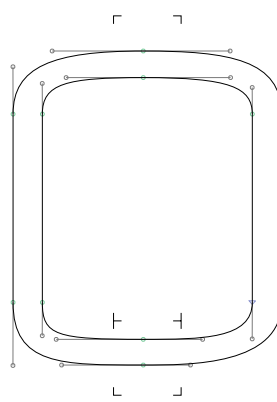

uni20E3 20E3

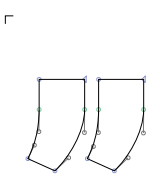

dblaptoprophe 02EE

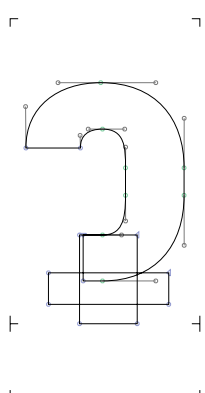

glottalstopbar 02A1

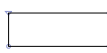

minus.dnomnosp 0320

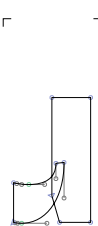

rturnsuper 02B4



linevert 02C8

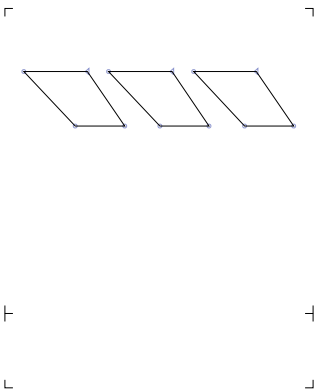

primitriplev1 2037



uni217F 217F



uni217E 217E



uni217D 217D



uni217C 217C

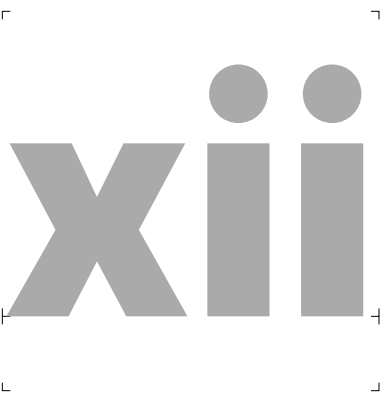

twelveroman 217B



elevenroman 217A

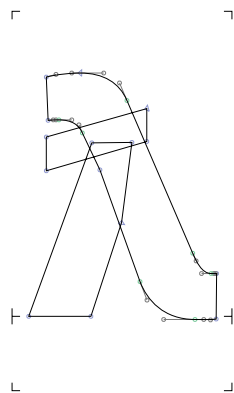

lambdabar 019B

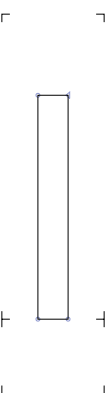

pipe 01C0



tenroman 2179



nineroman 2178



eightroman 2177



sevenroman 2176



fiveroman 2174

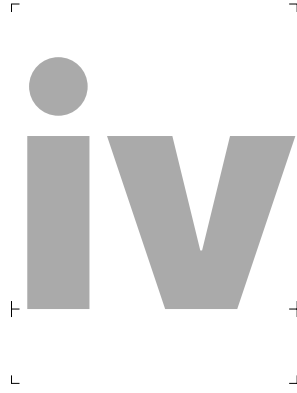

fourroman 2173

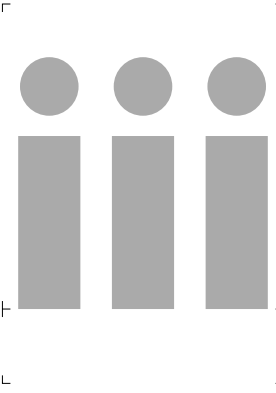

threeroman 2172



tworoman 2171



oneroman 2170

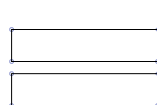

underscoredblno sp 0333

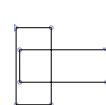

tackrightsubno sp 0319

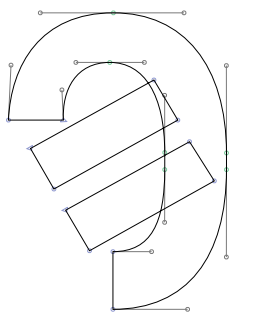

Sampi 03E0



schwa 0259

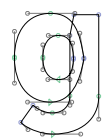

uni1DDA 1DDA

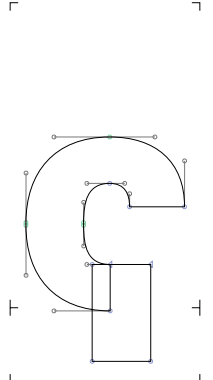

koppacyrillic 0481

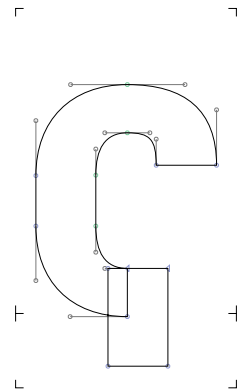

Koppacyrillic

0480

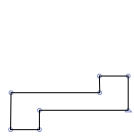

titlocyrlliccmb

0483

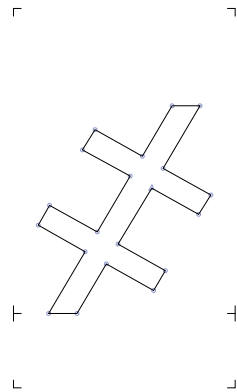

thousandcyrillic

0482



dasiapneumatocyrlliccmb

0485

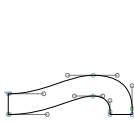

palatalizationcyrlliccmb

0484

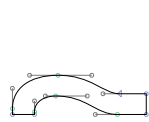

uni0487

0487



psilipneumatocyrlliccmb

0486

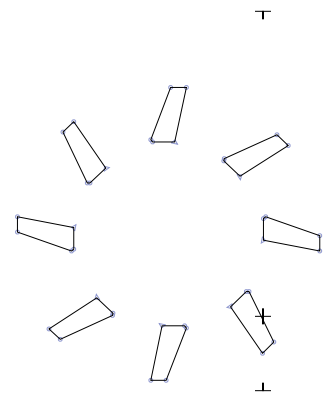

uni0489

0489

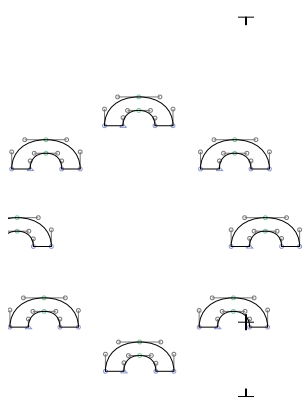

uni0488

0488

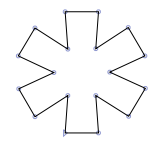

uni20F0

20F0

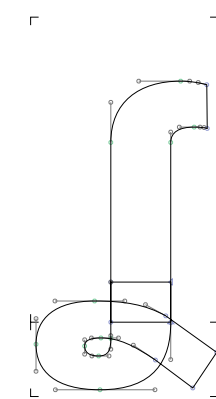

eshcurl

0286

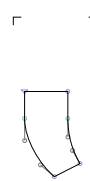

quotereversed

201B



romanfive

2164

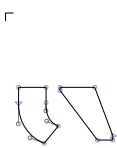

uni1FDD

1FDD

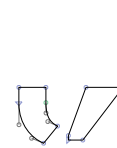

uni1FDE

1FDE

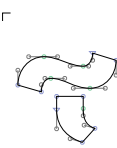

uni1FDF

1FDF

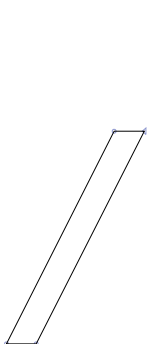

slashshortnosp

0337

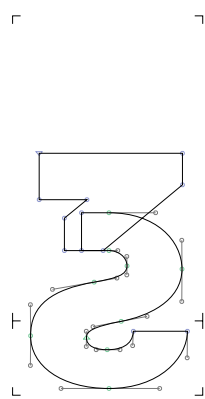

ezhtail

01BA

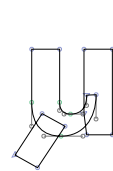

uni1DF0

1DF0

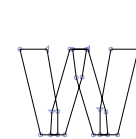

uni1DF1

1DF1

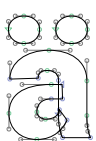

uni1DF2

1DF2

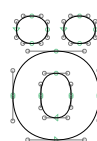

uni1DF3

1DF3

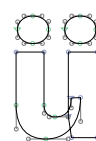

uni1DF4

1DF4



uni1DF5

1DF5



caronbelowcmb 032C



acutesubnosp 0317

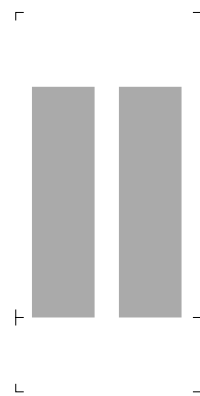

romantwo 2161

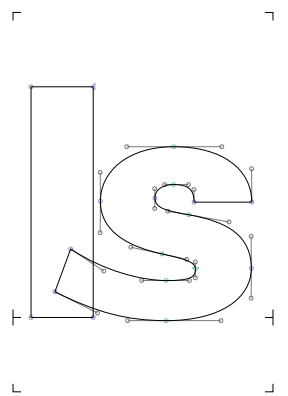

finalkaf 02AA



uni1DFC 1DFC



uni1DFD 1DFD



uni1DFE 1DFE

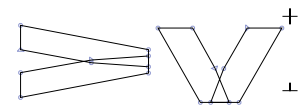

uni1DFF 1DFF



uni1FEF 1FEF



dblprimemod 02BA

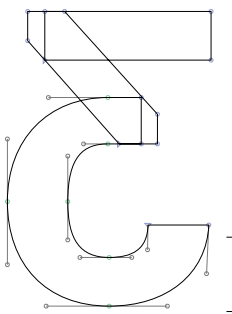

Ezhreversed 01B8

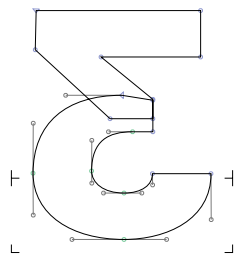

ezhreversed 01B9

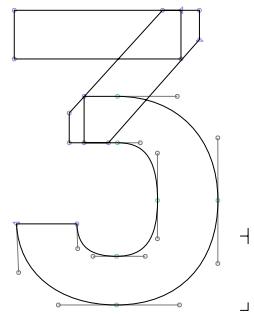

Ezh 01B7



romanfifty 216C



ringhalfright 02BE

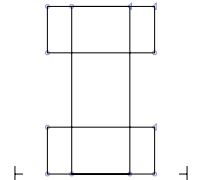

lsmallcap 026A

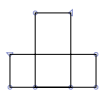

uptackmod 02D4



hyphendot 2027



uniFE29 FE29

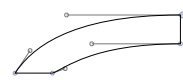

uniFE20 FE20

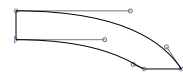

uniFE21 FE21



uniFE22 FE22



uniFE23 FE23



uniFE24 FE24

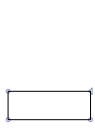

uniFE25 FE25

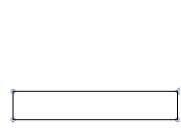

uniFE26 FE26

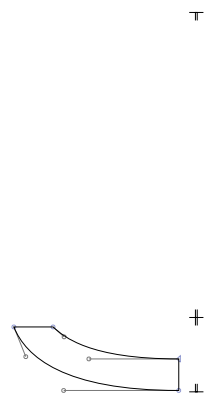

uniFE27 FE27

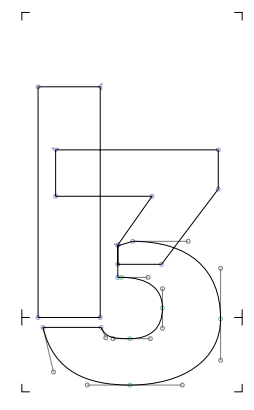

lyogh 026E



uniFE2A FE2A



uniFE2B FE2B



uniFE2C FE2C



uniFE2D FE2D

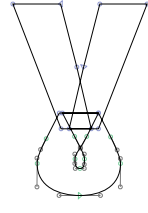

gammassuper 02E0

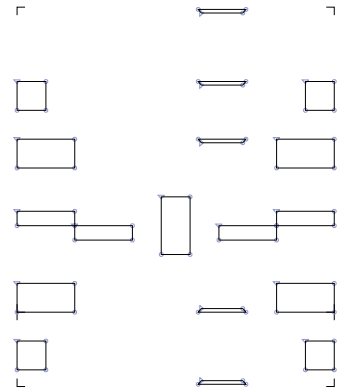

uniE001 E001

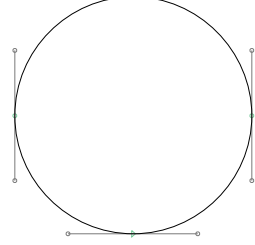

circleblack 25CF

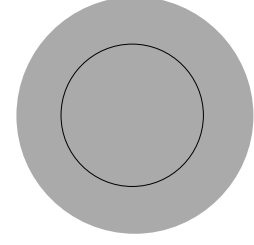

circlewhite 25CB

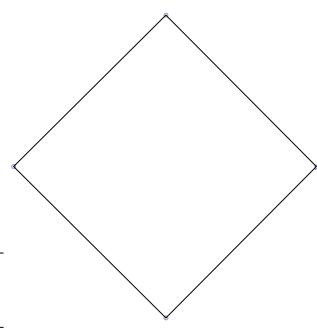

diamondblack 25C6

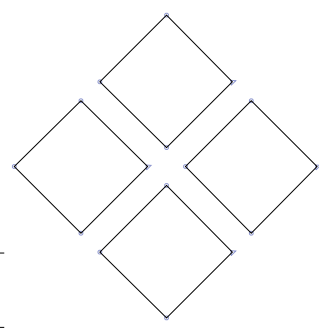

diamondblack_x 2756

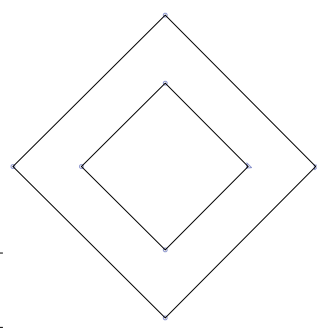

diamondwhite 25C7

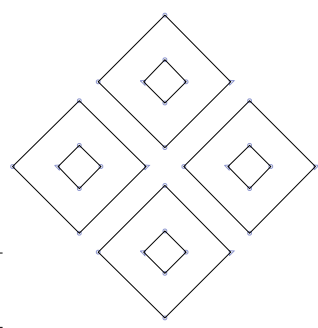

diamondwhite_x E000

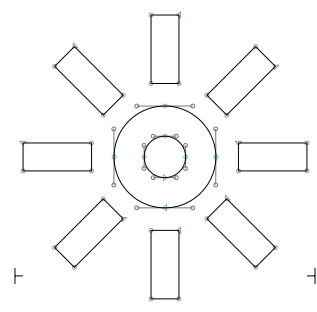

sunWithRays 263C

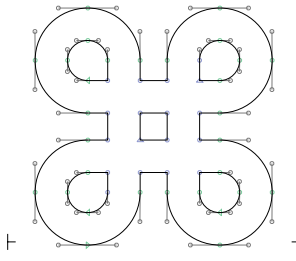

placeofinterestsign 2318



Eth 00D0

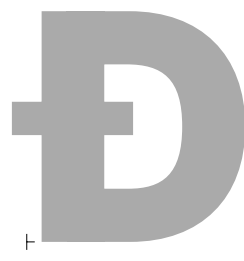

Dcroat 0110



IJ 0132



Ldot 013F



Tbar 0166



LJ 01C7

NJ DZ

NJ

01CA

DZ

01F1

Aogonek.NAV

Aogonek.NAV

Eogonek.NAV

Eogonek.NAV

Oogonek.NAV

Oogonek.NAV

uni03F7

uni03F7

03F7

afii10020

afii10020

0413

afii10052

afii10052

0403

afii10033

afii10033

041F

afii10034

afii10034

0420

afii10035

afii10035

0421

afii10036

afii10036

0422

afii10039

afii10039

0425

afii10146

afii10146

0462

Psicyrillic

Psicyrillic

0470

Ukcyrillic

Ukcyrillic

0478

uni048C

uni048C

048C

Ghestrokecyrillic

Ghestrokecyrillic

0492

Zedescendercyrillic

Zedescendercyrillic

0498

Esdescendercyrillic

Esdescendercyrillic

04AA

Tedescendercyrillic

Tedescendercyrillic

04AC

Ustraightcyrillic

Ustraightcyrillic

04AE

Ustraightstrokecyrillic

Ustraightstrokecyrillic

04B0

Chedescenderabkhasiancyrillic

Chedescenderabkhasiancyrillic

04BE



palochkacyrillic 04C0



Chekhakassiancyrillic 04CB

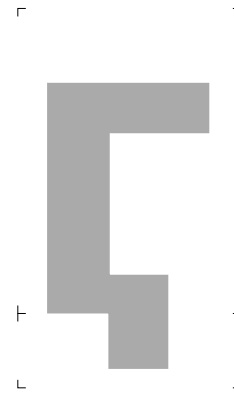

uni04F6 04F6

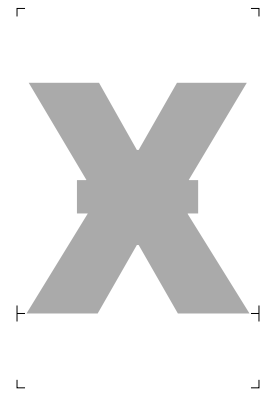

uni04FE 04FE

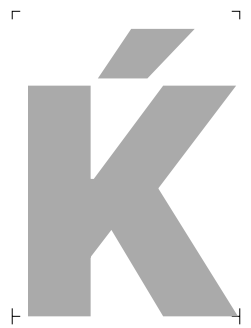

afi10061 040C



Schwadiesiscyrillic 04DA



Zhebrevecyrillic 04C1



Zhedieresiscyrillic 04DC



Zedieresiscyrillic 04DE

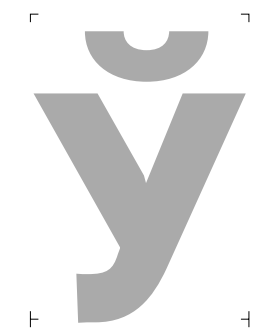

afi10062 040E



Umacroncyrillic 04EE



Udieresiscyrillic 04F0

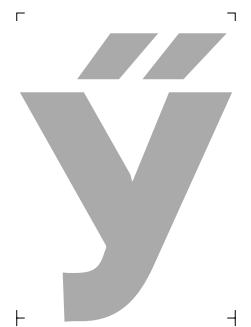

Ungarumlautcyrillic 04F2



Chedieresiscyrillic 04F4



Yerudieresiscyrillic 04F8



uni04EC 04EC



Izhitsadblgravecyrillic 0476



uni0299 0299



uni029C 029C



aogonek.NAV

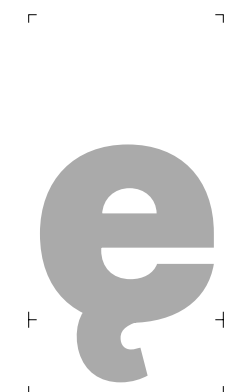

eogonek.NAV

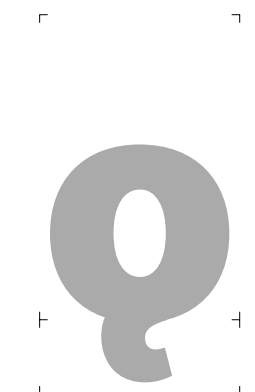

oogonek.NAV

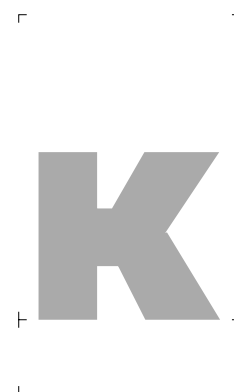

kappa

03BA

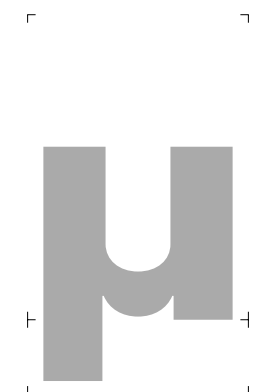

mugreek

03BC

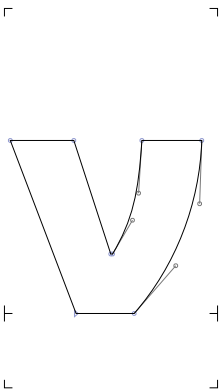

nu 03BD



uni03F8 03F8



uni1F71 1F71



uni1F73 1F73



uni1F75 1F75



uni1F77 1F77

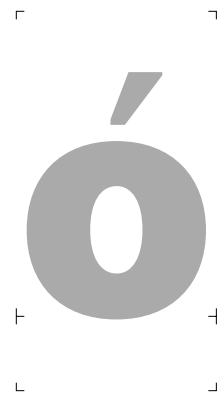

uni1F79 1F79



uni1F7B 1F7B



uni1F7D 1F7D



uni1FD3 1FD3



uni1FE3 1FE3



psicyrillic 0471



ghestrokecyrillic 0493



zedescendercyrillic 0499



esdescendercyrillic 04AB



tedescendercyrillic 04AD



ustraightcyrillic 04AF



ustraightstrokecyrillic 04B1



chedescenderabkhasiancyrillic 04BF



chekhakassiancyrillic 04CC



schwacyrillic 04D9



schwadiesiscyrlilic 04DB



obarredcyrillic 04E9



obarreddieresiscyrlilic 04EB



uni04F7

04F7



uni04FF

04FF



chedieresiscyrillic

04F5

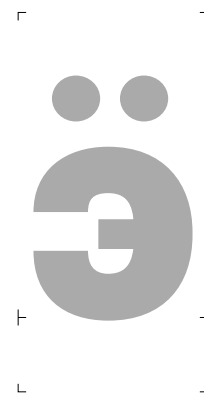

uni04ED

04ED



gjecyrillic

0453



iishortcyrillic

0439



uni045D

045D



imacroncyrillic

04E3



idieresiscyrillic

04E5



izhitsadblgravecyrillic

0477



kjecyrillic

045C



yerudieresiscyrillic

04F9



zedieresiscyrillic

04DF



zhebrevecyrillic

04C2



zhedieresiscyrillic

04DD



Ezhcaron

01EE

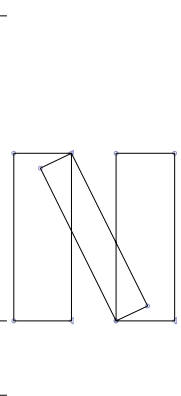

Nsmallcap

0274

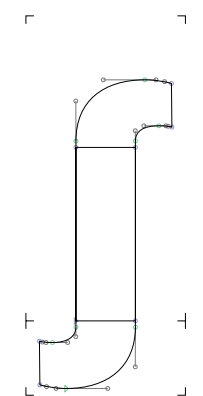

esh

0283

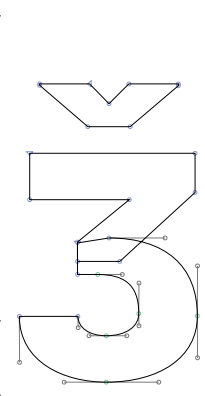

ezhcaron

01EF

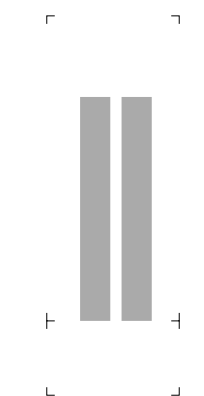

pipedbl

01C1

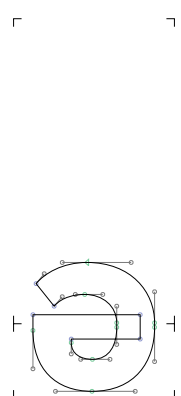

uni2094

2094

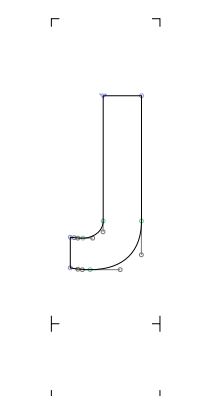

uni02B2.ccmp



Eltail-cy

04C5

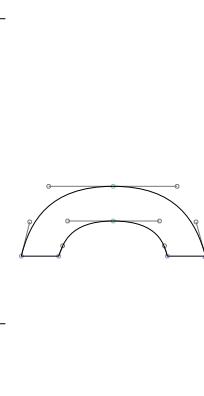

uniA92E

A92E

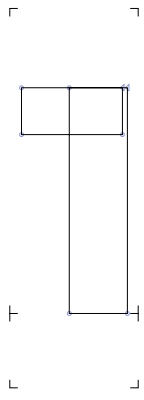

tonebarextrahighmod.cn 02E5

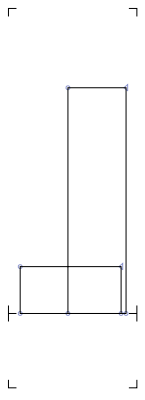

tonebarextralowmod.cn 02E9

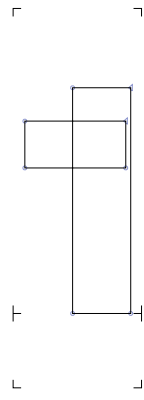

tonebarhighmod.cn 02E6

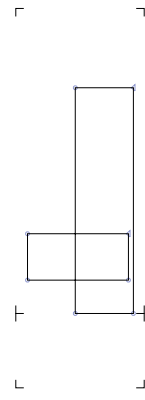

tonebarlowmod.cn 02E8

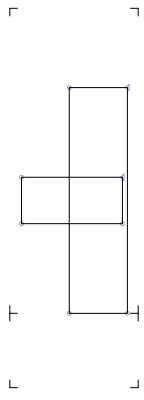

tonebarmidmod.cn 02E7



commaabovecmb 0313



commaaboverightcmb 0315

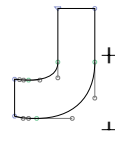

hooksubpalatosp 0321



bridgeinvsubnosp 033A

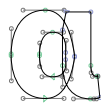

uni1DE7 1DE7

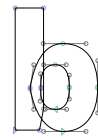

uni1DE8 1DE8

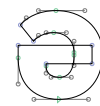

uni1DEA 1DEA

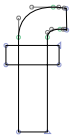

uni1DEB 1DEB

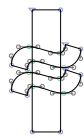

uni1DEC 1DEC

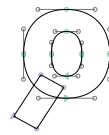

uni1DED 1DED



uni1DEE 1DEE

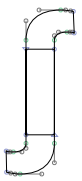

uni1DEF 1DEF

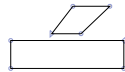

macronacutecomb.cn

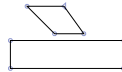

macrongravecomb.cn



uni1FFE.tonos



uni1FCD.tonos



uni1FDD.tonos



uni1FCE.tonos



uni1FDE.tonos



uni1FCF.tonos



uni1FDF.tonos



uni1FEF.tonos



uni1FFD.tonos



uni1DE0



uni1DE1

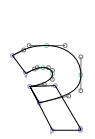

uni1DE3



uni1DE4



uni1DE5

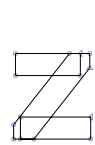

uni1DE6



cyrillicic.cn



controlHT



controlSOT



commaaccentright.cn

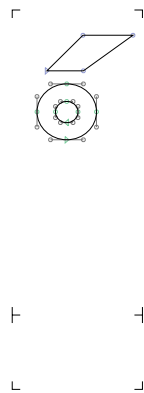

ringacute.cn

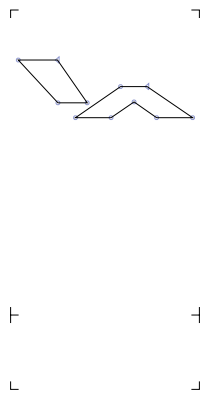

circumflexgravecomb.cn

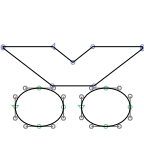

dieresiscaroncomb.cn

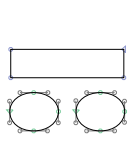

dieresismacroncomb.cn

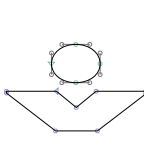

carondotcomb.cn

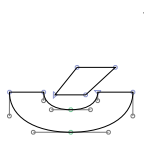

breveacutecomb.cn

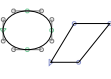

acutedotcomb.cn

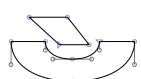

brevegravecomb.cn

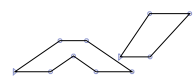

circumflexacutecomb.cn

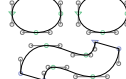

tildedieresiscomb.cn

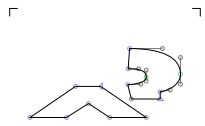

circumflexhookcomb.cn

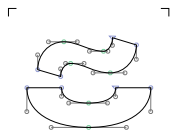

brevetildecomb.cn

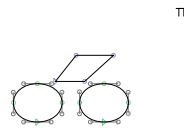

dieresisacutecomb.cn

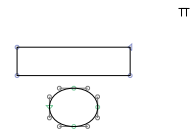

dotmacroncomb.cn

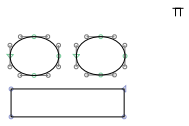

macrondieresiscomb.cn

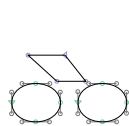

dieresisgravecomb.cn

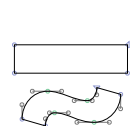

tildemacroncomb.cn

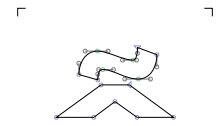

circumflextildecomb.cn

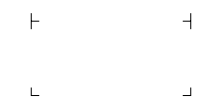
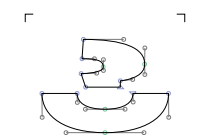

brevehookcomb.cn

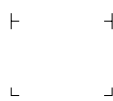
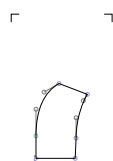

commaaccentrotate.cn

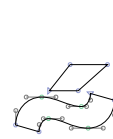

tildeacutecomb.cn

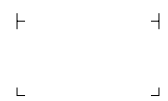
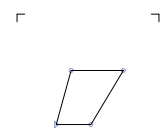

tonostop

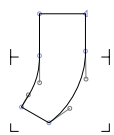

cyrillictail.cn

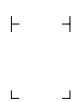

koronisaccentleft.cn