

A 0041



Adieresis 00C4



Atilde 00C3



Agrave 00C0



Aacute 00C1



Acircumflex 00C2



Aring 00C5



Amacron 0100



Abreve 0102



Aogonek 0104



Acaron 01CD



Adieresismacron 01DE



Adotmacron 01E0



Aringacute 01FA



Adblgrave 0200



Ainvertedbreve 0202



uni0226 0226



Aringbelow 1E00



Adotbelow 1EA0



Ahookabove 1EA2



Acircumflexacute 1EA4



Acircumflexgrave 1EA6



Acircumflexhookabove 1EA8



Acircumflextilde 1EAA



Acircumflexdotbelow 1EAC



Abreveacute 1EAE



Abrevegrave 1EB0



Abrevehookabove 1EB2



Abrevetilde 1EB4



Abrevedotbelow 1EB6



Alpha 0391



Alphanos 0386



uni1F08 1F08



uni1F09 1F09



uni1F0A 1F0A



uni1F0B 1F0B



uni1F0C 1F0C



uni1F0D 1F0D



uni1F0E 1F0E



uni1F0F 1F0F



uni1F88 1F88



uni1F89 1F89



uni1F8A 1F8A

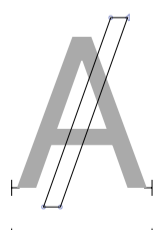

uni023A 023A



uni1F8B 1F8B



afii10017 0410



Abrevycrillic 04D0



Adieresiscyrillic 04D2



uni1F88 1F88



uni1F89 1F89



uni1F8A 1F8A



uni1F8B 1F8B



uni1F8C 1F8C



uni1F8D 1F8D



uni1F8E 1F8E



uni1F8F 1F8F



uni1FBC 1FBC

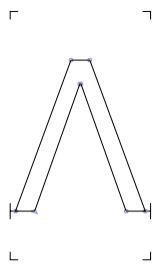

Lambda 039B

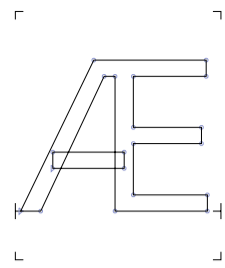

AE 00C6

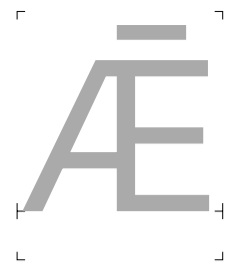

AEmacron 01E2



AEacute 01FC



Aicyrillic 04D4

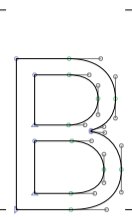

B 0042



Bdotaccent 1E02



Bdotbelow 1E04



Blinebelow 1E06



uni0243 0243

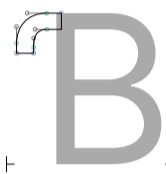

Bhook 0181



afii10019 0412



Beta 0392

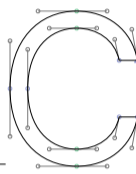

C 0043



Chook 0187



Ccedilla 00C7

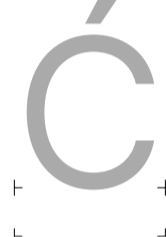

Cacute 0106



Ccircumflex 0108



Cdotaccent 010A



Ccaron 010C



Ccedillaacute 1E08

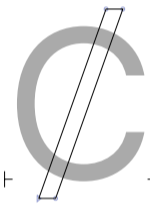

uni023B 023B

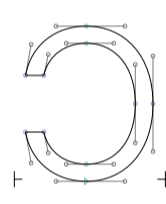

Oopen 0186



uni03F9 03F9

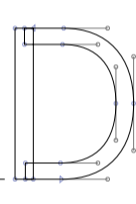

D 0044



Dhook 018A



Dcaron 010E



Ddotaccent 1E0A



Ddotbelow 1E0C



Dlinebelow 1E0E



Dcedilla 1E10



Dcircumflexbelow 1E12



Dbar1 0189



Dz 01F2



Dzcaron_ 01C5

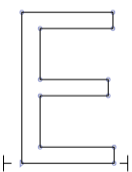

E 0045



Egrave 00C8



Eacute 00C9



Ecircumflex 00CA



Edieresis 00CB



Emacron 0112



Ebreve 0114



Edotaccent 0116



Eogonek 0118



Ecaron 011A



Edblgrave 0204



Einvertedbreve 0206



uni0228 0228



Emacrongrave 1E14



Emacronacute 1E16



Ecircumflexbelow 1E18



Etildebelow 1E1A



Ecedillabreve 1E1C



Edotbelow 1E88

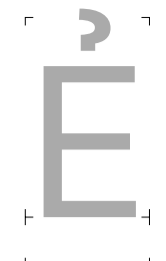

Ehookabove 1E8A



Etilde 1EBC



Ecircumflexacute 1E8E



Ecircumflexgrave 1E00



Ecircumflexhookabove 1E02



Ecircumflextilde 1E04



Ecircumflexdotbelow 1E06

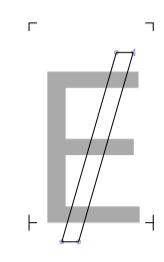

uni0246 0246



Eturn 018E



Epsilon 0395



Epsilontonos 0388



uni1F18 1F18



uni1F19 1F19



uni1F1A 1F1A



uni1F1B 1F1B



uni1F1C 1F1C



uni1F1D 1F1D



uni1FC8 1FC8



uni1FC9 1FC9



afii10022 0415



uni0400 0400



afii10023 0401



lebrevecyrillic 04D6

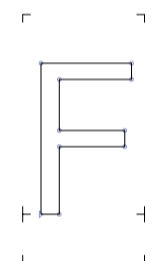

F 0046



Fhook 0191



Fdotaccent 1E1E



Fturn 2132

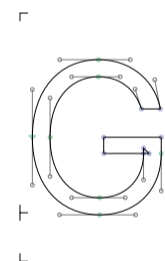

G 0047

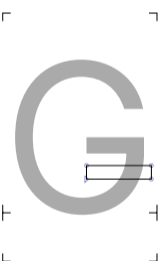

Gbar 01E4



Ghook 0193



Gcircumflex 011C



Gbreve 011E



Gdotaccent 0120



Gcommaaccent 0122



Gcaron 01E6



Gacute 01F4



Gmacron 1E20

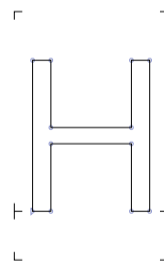

H 0048



Hcedilla 1E28



Hcircumflex 0124

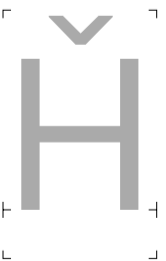

uni021E 021E

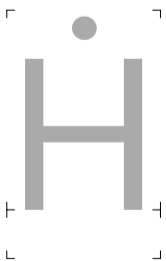

Hdotaccent 1E22

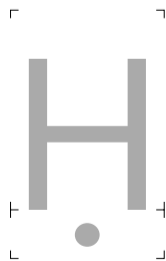

Hdotbelow 1E24



Hdieresis 1E26



Hbrevebelow 1E2A

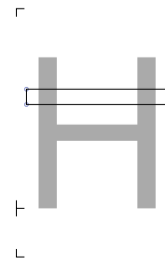

Hbar 0126

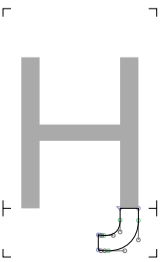

Ehookcyrillic 04C7

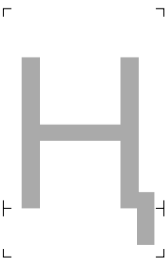

Endescendercyrillic 04A2

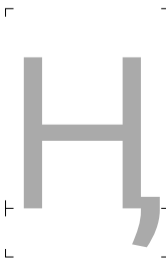

uni04C9 04C9

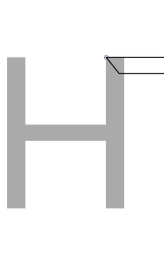

Enghecyrillic 04A4

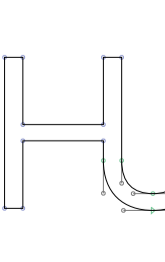

uni01F6 01F6

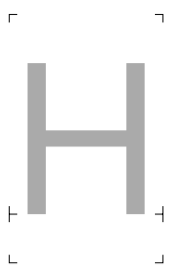

Eta 0397

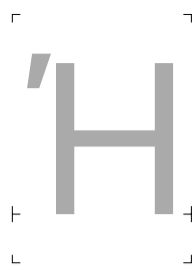

Etatonos 0389



uni1F28 1F28

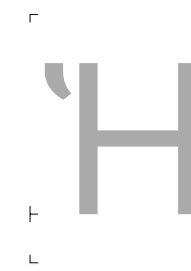

uni1F29 1F29



uni1F2A 1F2A

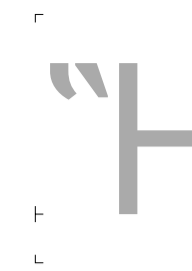

uni1F2B 1F2B



uni1F2C 1F2C



uni1F2D 1F2D



uni1F2E 1F2E



uni1F2F 1F2F

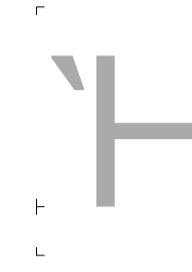

uni1FCA 1FCA

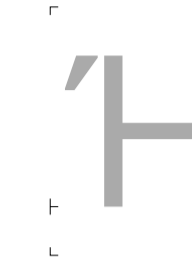

uni1FCB 1FCB



afi10031 041D



uni1F98 1F98



uni1F99 1F99



uni1F9A 1F9A



uni1F9B 1F9B



uni1F9C 1F9C



uni1F9D 1F9D



uni1F9E 1F9E



uni1F9F 1F9F



uni1FCC 1FCC

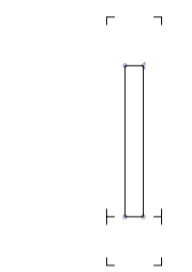

I 0049

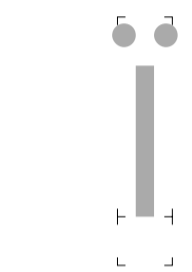

Idieresis 00CF

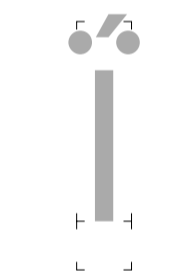

Idieresisacute 1E2E

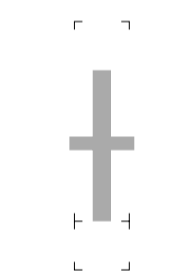

Istroke 0197

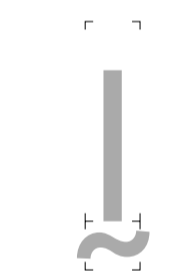

Itildebelow 1E2C

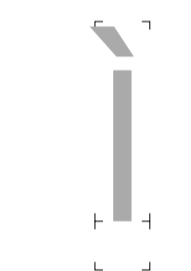

Igrave 00CC

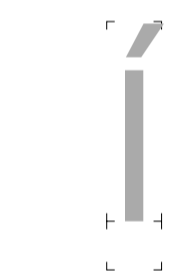

Iacute 00CD

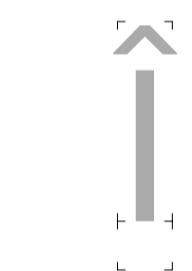

Icircumflex 00CE

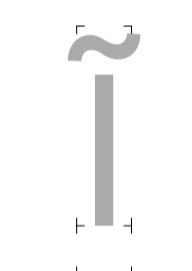

Itilde 0128

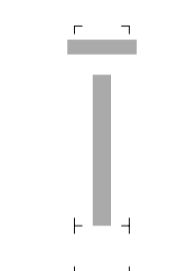

Imacron 012A

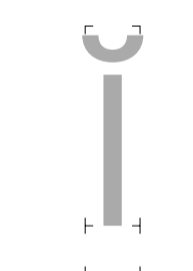

Ibreve 012C

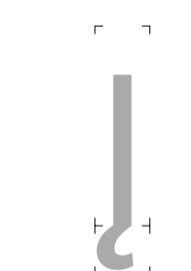

Iogonek 012E

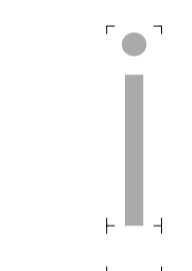

Idotaccent 0130

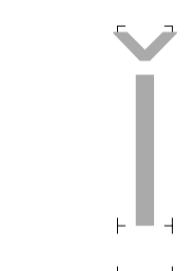

Icaron 01CF

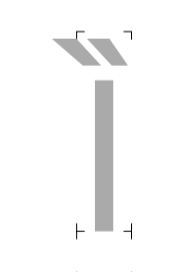

Idblgrave 0208

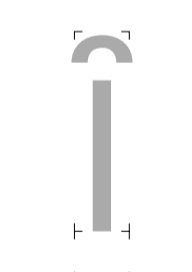

Iinvertedbreve 020A

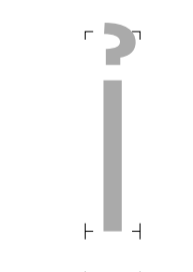

Ihookabove 1EC8

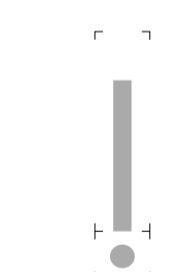

Icdotbelow 1ECA

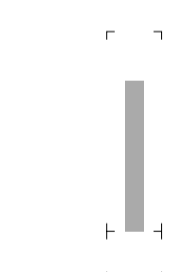

Iota 0399

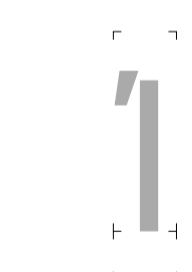

Iotatonos 038A

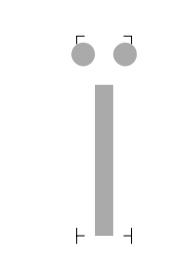

Iotadieresis 03AA



uni1F38 1F38

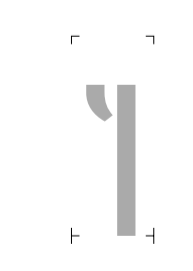

uni1F39 1F39



uni1F3A 1F3A



uni1F3B 1F3B



uni1F3C 1F3C

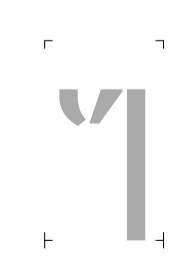

uni1F3D 1F3D

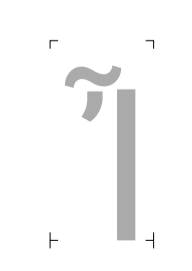

uni1F3E 1F3E

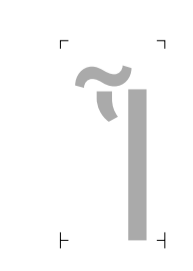

uni1F3F 1F3F

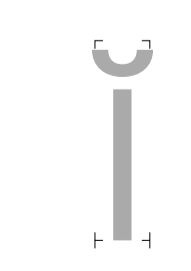

uni1FD8 1FD8

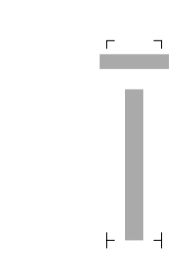

uni1FD9 1FD9



uni1FDA 1FDA

uni1FDB 1FDB afii10055 0406 afii10056 0407 l.1 ldieresis.1 ldieresisacute.1

lstroke.1 ltildebelow.1 lgrave.1 lacute.1 lcircumflex.1 ltilde.1

lmacron.1 lbreve.1 logonek.1 ldotaccent.1 lcaron.1 ldblgrave.1

linvertedbreve.1 lhookabove.1 ldotbelow.1 uni1F38.1 uni1F39.1 uni1F3A.1

uni1F3B.1 uni1F3C.1 uni1F3D.1 uni1F3E.1 uni1F3F.1 uni1FD8.1

uni1FD9.1 uni1FDA.1 uni1FDB.1 afii10055.1 afii10056.1 J 004A

Jcircumflex 0134 uni0248 0248 uni037F 037F afii10057 0408 K 004B Kcommaaccent 0136

Kcaron 01E8 Kacute 1E30 Kdotbelow 1E32 Klinebelow 1E34 Kabashkircyrillic 04A0 Kadescendercyrillic 049A

Khook 0198 Kappa 039A L 004C Lacute 0139 Lcommaaccent 013B Lcaron 013D



Ldotbelow 1E36



Ldotbelowmacron 1E38



Llinebelow 1E3A



Lcircumflexbelow 1E3C

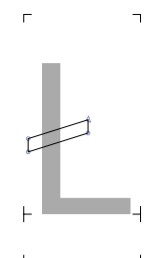

Lslash 0141

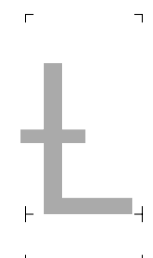

Lbar 023D



Lj 01C8

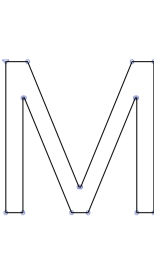

M 004D



Macute 1E3E



Mdotaccent 1E40



Mdotbelow 1E42



uni04CD 04CD



Mu 039C



uni03FA 03FA



afii10030 041C

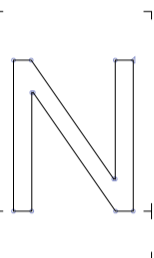

N 004E



Ntilde 00D1



Nacute 0143



Ncommaaccent 0145



Ncaron 0147



uni01F8 01F8



Ndotaccent 1E44



Ndotbelow 1E46



Nlinebelow 1E48



Ncircumflexbelow 1E4A



Nhook 019D



Eng 014A



afii10026 0418



uni040D 040D



afii10027 0419



Imacroncyrillic 04E2



Idieresiscyrillic 04E4



uni048A 048A



uni0376 0376



Nu 039D



Nj 01CB

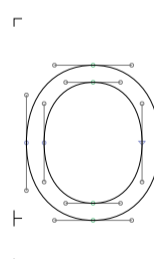

O 004F

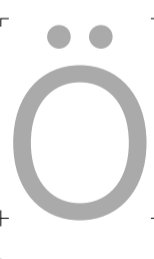

Odieresis 00D6



Otilde 00D5

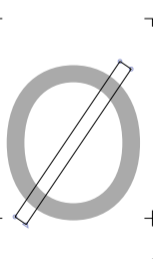

Oslash 00D8

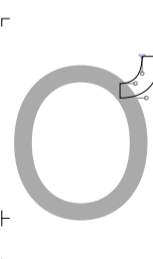

Ohorn 01A0

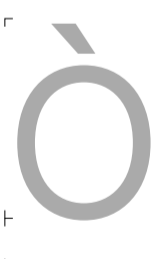

Ograve 00D2



Oacute 00D3

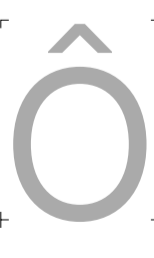

Ocircumflex 00D4



Omacron 014C

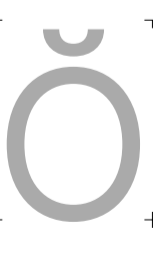

Obreve 014E



Ohungarumlaut 0150



Ocaron 01D1



Oogonek 01EA

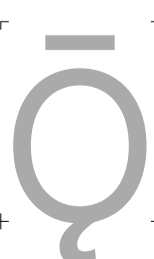

Oogonekmacron 01EC



Odblgrave 020C

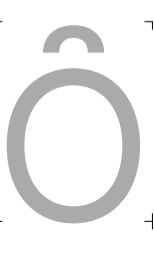

Oinvertedbreve 020E

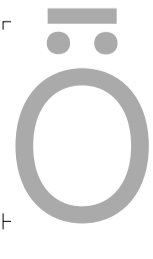

uni022A 022A

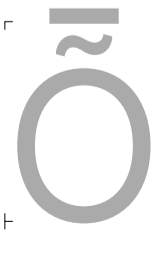

uni022C 022C

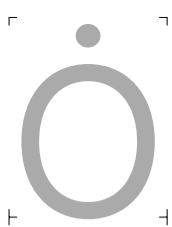

uni022E 022E

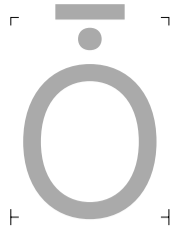

uni0230 0230



Otildeacute 1E4C



Otildedieresis 1E4E



Omacrongrave 1E50

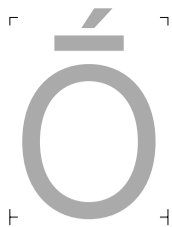

Omacronacute 1E52

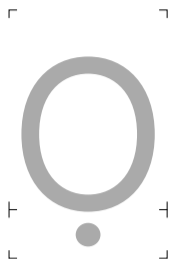

Odotbelow 1ECC

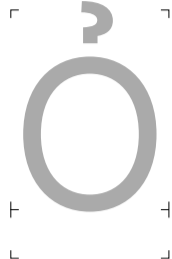

Ohookabove 1ECE

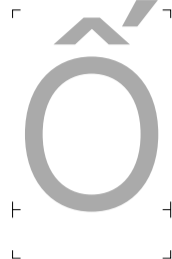

Ocircumflexacute 1ED0

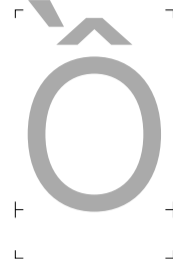

Ocircumflexgrave 1ED2

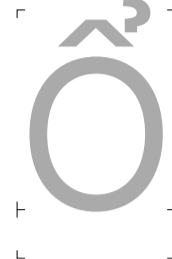

Ocircumflexhookabove 1ED4

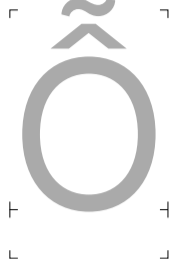

Ocircumflextilde 1ED6

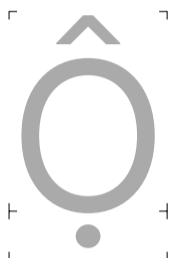

Ocircumflexdotbelow 1ED8

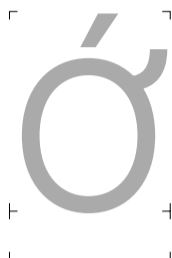

Ohornacute 1EDA

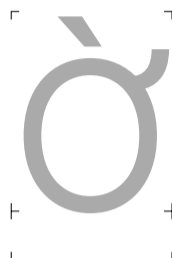

Ohorngrave 1EDC

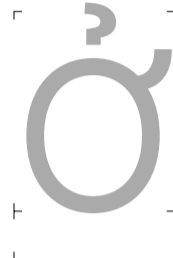

Ohornhookabove 1EDE



Ohorntilde 1EE0

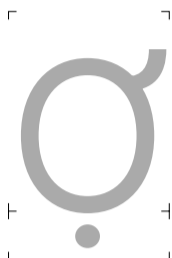

Ohorndotbelow 1EE2



Oslashacute 01FE

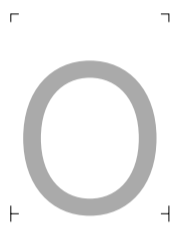

Omicron 039F



Omicrontonos 038C



uni1F48 1F48



uni1F49 1F49



uni1F4A 1F4A



uni1F4B 1F4B



uni1F4C 1F4C



uni1F4D 1F4D



uni1FF8 1FF8



uni03F4 03F4



uni1FF9 1FF9

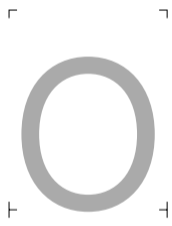

afi10032 041E



Odieresiscyrillic 04E6



Obar 019F



Obarredcyrillic 04E8



Obarreddieresiscyrillic 04EA

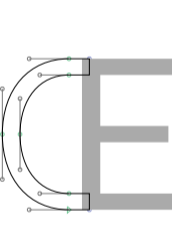

OE 0152

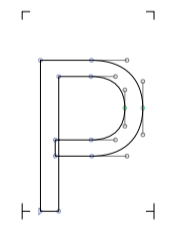

P 0050



Pacute 1E54



Pdotaccent 1E56

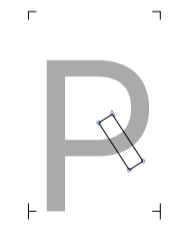

uni048E 048E

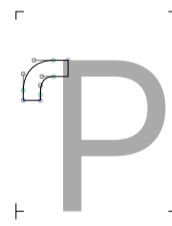

Phook 01A4



Rho 03A1



uni1FEC 1FEC

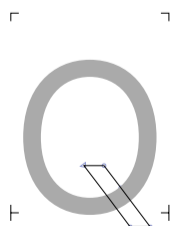

Q 0051

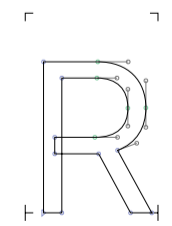

R 0052



Racute 0154



Rcommaaccent 0156



Rcaron 0158



Rdblgrave 0210



Rinvertedbreve 0212



Rdotaccent 1E58



Rdotbelow 1E5A



Rdotbelowmacron 1E5C



Rlinebelow 1E5E

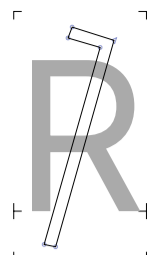

response 211F

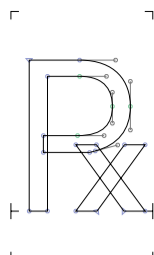

Rx 211E

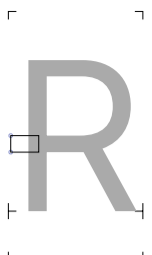

uni024C 024C

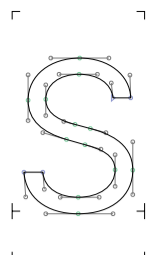

S 0053



Sacute 015A



Scircumflex 015C



Scedilla 015E



Scaron 0160



Scommaaccent 0218



Sdotaccent 1E60



Sdotbelow 1E62



Sacutedotaccent 1E64



Scarondotaccent 1E66



Sdotbelowdotaccent 1E68



afii10054 0405



Tonetwo 01A7

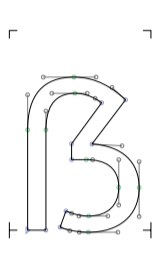

Germandbls 1E9E

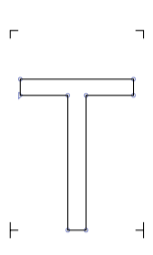

T 0054



Tcommaaccent 0162



Tcaron 0164



uni021A 021A



Tdotaccent 1E6A



Tdotbelow 1E6C



Tlinebelow 1E6E



Tcircumflexbelow 1E70

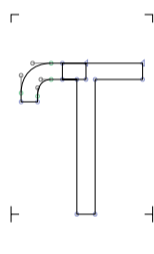

Thook 01AC



Trthook 01AE

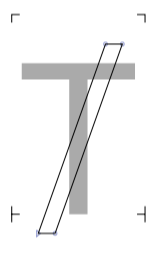

uni023E 023E



Tau 03A4

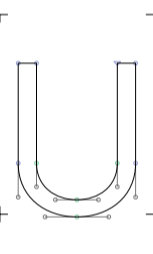

U 0055



Uhorn 01AF



Ugrave 00D9



Uacute 00DA



Ucircumflex 00DB



Udieresis 00DC



Utilde 0168



Umacron 016A



Ubreve 016C



Uring 016E



Uhungarumlaut 0170



Uogonek 0172



Ucaron 01D3



Udieresismacron 01D5



Udieresisacute 01D7



Udieresiscaron 01D9



Udieresisgrave 01DB



Udblgrave 0214



Uinvertedbreve 0216



Udieresisbelow 1E72



Utildebelow 1E74



Ucircumflexbelow 1E76



Utildeacute 1E78



Umacrondieresis 1E7A



Udotbelow 1EE4



Uhookabove 1EE6

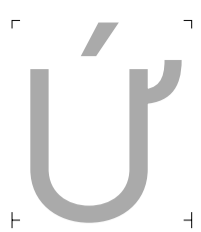

Uhornacute 1EE8

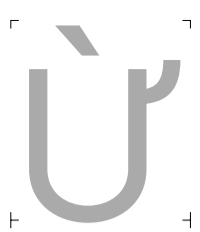

Uhorngrave 1EEA

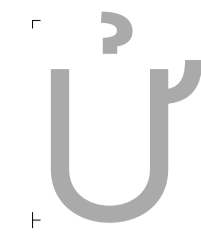

Uhornhookabove 1EEC

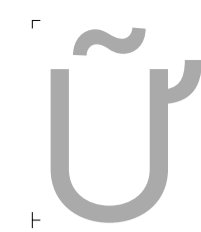

Uhorntilde 1EEE



Uhorndotbelow 1EF0

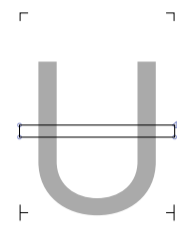

uni0244 0244

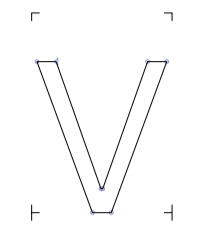

V 0056

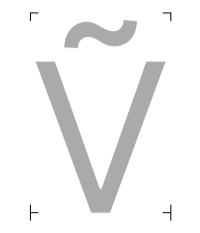

Vtilde 1E7C

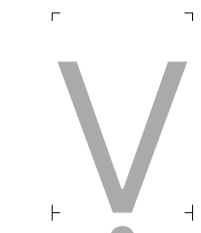

Vdotbelow 1E7E

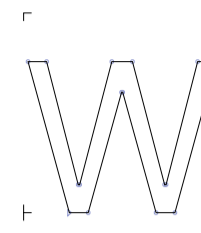

W 0057

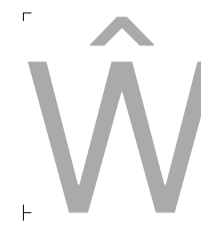

Wcircumflex 0174



Wgrave 1E80



Wacute 1E82



Wdieresis 1E84



Wdotaccent 1E86



Wdotbelow 1E88

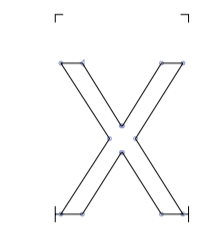

X 0058



Xdotaccent 1E8A

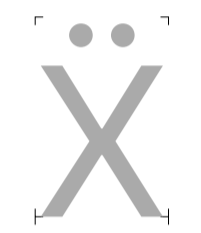

Xdieresis 1E8C

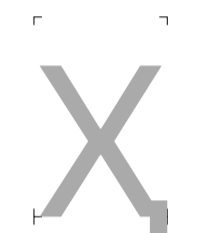

Hadescendercyrillic 04B2

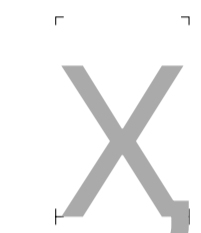

uni04FC 04FC

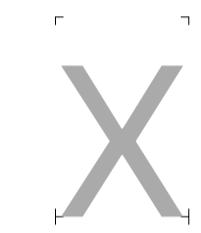

Chi 03A7

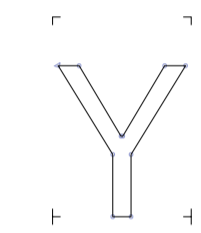

Y 0059

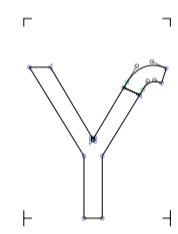

Yhook 01B3

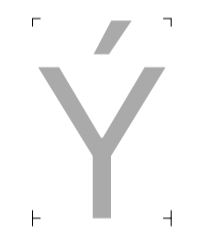

Yacute 00DD

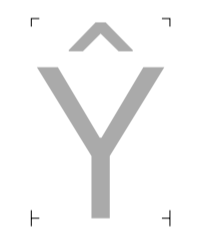

Ycircumflex 0176



Ydieresis 0178

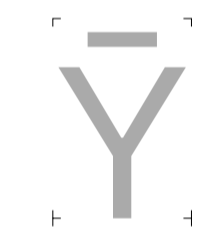

uni0232 0232

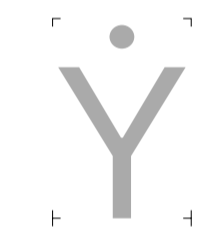

Ydotaccent 1E8E



Ygrave 1EF2

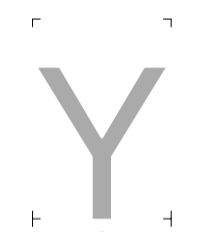

Ydotbelow 1EF4

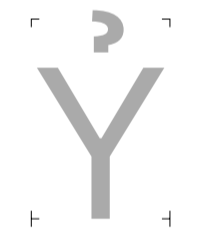

Yhookabove 1EF6



Ytilde 1EF8

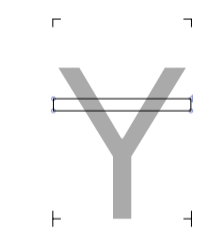

uni024E 024E

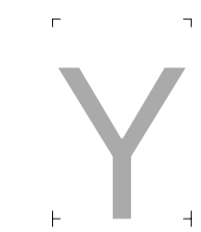

Upsilon 03A5



Upsilonontonos 038E



Upsilondieresis 03AB



uni1F59 1F59



uni1F5B 1F5B



uni1F5D 1F5D

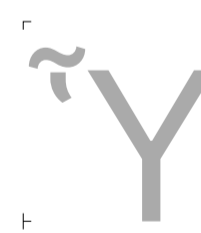

uni1F5F 1F5F



uni1FE8 1FE8



uni1FE9 1FE9

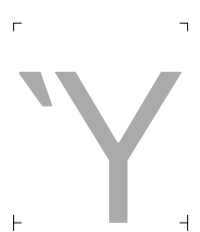

uni1FEA 1FEA

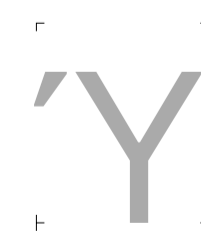

uni1FEB 1FEB

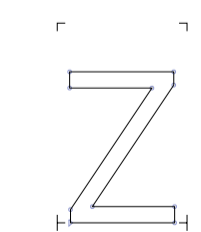

Z 005A



Zacute 0179



Zdotaccent 017B



Zcaron 017D

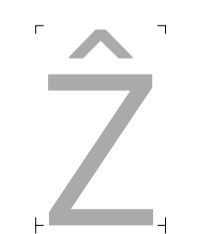

Zcircumflex 1E90



Zdotbelow 1E92



Zlinebelow 1E94

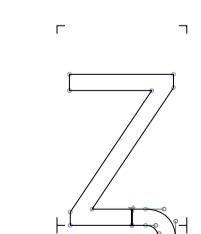

uni0224 0224



Zbar 01B5



Zeta 0396

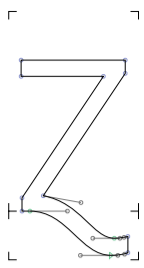

uni2C7F 2C7F

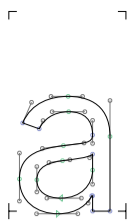

a 0061



adieresis 00E4



atilde 00E3



arighthalfring 1E9A



agrave 00E0



aacute 00E1



acircumflex 00E2



aring 00E5



amacron 0101



abreve 0103



aogonek 0105



acaron 01CE



adieresismacron 01DF



adotmacron 01E1



aringacute 01FB



adblgrave 0201



ainvertedbreve 0203



uni0227 0227



aringbelow 1E01



adotbelow 1EA1



ahookabove 1EA3



acircumflexacute 1EA5



acircumflexgrave 1EA7



acircumflexhookabove 1EA9



acircumflextilde 1EAB



acircumflexdotbelow 1EAD



abreveacute 1EAF



abrevegrave 1EB1



abrevehookabove 1EB3



abrevetilde 1EB5



abrevedotbelow 1EB7



aturn 0250



afii10065 0430



abrevacyrillic 04D1



adieresiscyrillic 04D3

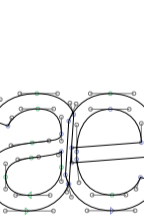

ae 00E6



aemacron 01E3



aeacute 01FD



aicyrillic 04D5

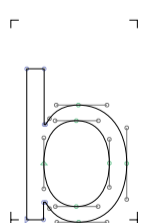

b 0062



bbar 0180

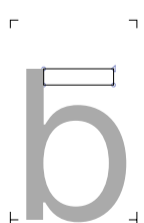

btopbar 0183

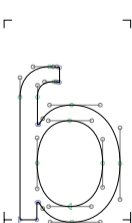

bhook 0253



bdotaccent 1E03



bdotbelow 1E05



blinedbelow 1E07

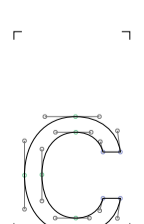

c 0063

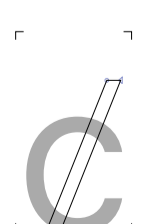

uni023C 023C

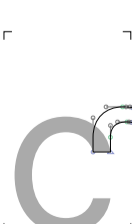

chook 0188

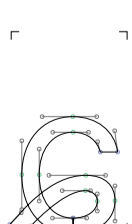

ccurl 0255



ccedilla 00E7



cacute 0107



ccircumflex 0109



cdotaccent 010B



ccaron 010D



ccedillaacute 1E09



sigmaunatesymbolgreek 03F2



escyrillic 0441



d 0064



dcroat 0111



drthook 0256

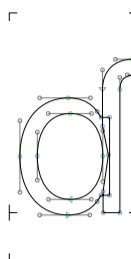

dhook 0257



dtopbar 018C



uni0221 0221



dcaron 010F



ddotaccent 1E0B



ddotbelow 1E0D



dlinebelow 1E0F



dcedilla 1E11



dcircumflexbelow 1E13



dz 02A3



dzcaron 01C6



dzcurl 02A5

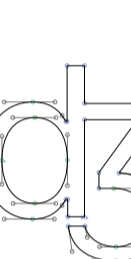

dyogh 02A4



dong 20AB

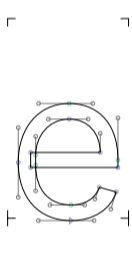

e 0065



edieresis 00EB

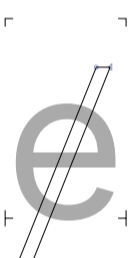

uni0247 0247



egrave 00E8



eacute 00E9



ecircumflex 00EA



emacron 0113



ebreve 0115



edotaccent 0117



eogonek 0119



ecaron 011B



edblgrave 0205



einvertedbreve 0207



uni0229 0229



emacrongrave 1E15



emacronacute 1E17



ecircumflexbelow 1E19



etildebelow 1E1B



ecedillabreve 1E1D



edotbelow 1E19



ehookabove 1EBB



etilde 1EBD



ecircumflexacute 1EBF



ecircumflexgrave 1EC1



ecircumflexhookabove 1EC3



ecircumflextilde 1EC5



ecircumflexdotbelow 1EC7



icyrillic 0435

























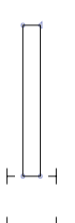
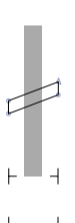

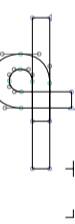
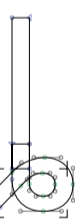







uni0450 0450

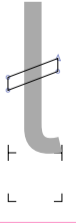

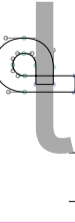
icyrillic 0451

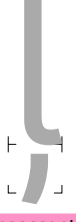
					
iebrevecyrillic 04D7	eturn 01DD	f 0066	slongstroke 1E9C	slongdotaccent 1E9B	fdotaccent 1E1F
					
feng 02A9	g 0067	ghook 0260	gbar 01E5	gcircumflex 011D	gbreve 011F
					
gdotaccent 0121	gcommaaccent 0123	gcaron 01E7	gacute 01F5	gmacron 1E21	h 0068
					
hcedilla 1E29	tshecyrillic 045B	djecyrillic 0452	hhook 0266	henghook 0267	hv 0195
					
hturn 0265	hturnlthook 02AE	hturnhook2 02AF	hbar 0127	hcircumflex 0125	uni021F 021F
					
hdotaccent 1E23	hdotbelow 1E25	hdieresis 1E27	hbrevebelow 1E2B	hlinebelow 1E96	shhacyrillic 04BB
					
i 0069	idotless 0131	idieresis 00EF	idieresisacute 1E2F	itilde 0129	itildebelow 1E2D
					
uni1E2D.ccmp	ibar 0268	igrave 00EC	iacute 00ED	icircumflex 00EE	imacron 012B
					
ibreve 012D	uni012F.ccmp	iogonek 012F	icaron 01D0	idblgrave 0209	iinvertedbreve 020B

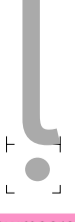
					
ihookabove 1EC9	idotbelow 1ECB	uni1ECB.ccmp	jdotless 0237	jdotlessbar 025F	uni0249 0249
					
uni0249.ccmp	icyrillic 0456	yicyrillic 0457	ij 0133	j 006A	jcrosstail.ccmp
					
jcrosstail 029D	jcircumflex 0135	jcaron 01F0	yotgreek 03F3	jecyrillic 0458	lj 01C9
					
k 006B	khook 0199	kcommaaccent 0137	kcaron 01E9	kacute 1E31	kdotbelow 1E33
					
klinebelow 1E35	kturn 029E	l 006C	lslash 0142	lbar 019A	lmidtilde 026B
					
lrhook 026D	lbelt 026C	lcurl 0234	ldot 0140	lacute 013A	lcommaaccent 013C
					
lcaron 013E	ldotbelow 1E37	ldotbelowmacron 1E39	llinebelow 1E3B	lcircumflexbelow 1E3D	l.ss02
					
lslash.ss02	lbar.ss02	lmidtilde.ss02	lbelt.ss02	ldot.ss02	lacute.ss02
					
lcommaaccent.ss02	lcaron.ss02	ldotbelow.ss02	ldotbelowmacron.ss02	llinebelow.ss02	lcircumflexbelow.ss02

l uni04CF 04CF m 006D mhook 0271 mturn 026F mturndescend 0270 macute 1E3F

ṁ ṃ n ntilde ñ nrhook eng

n ncurl nlfthook nlegrightlong nacute ncommaaccent ncaron

ñ uni01F9 01F9 ñ ndotaccent ñ ndotbelow ñ nlinebelow ñ ncircumflexbelow nj

o 006F ö odieresis õ otilde oslash ohorn ograve



















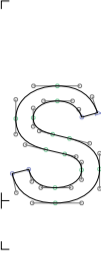













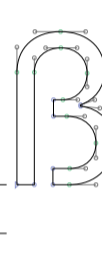
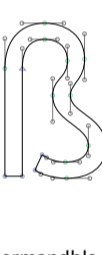
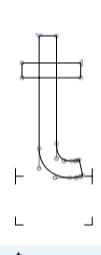
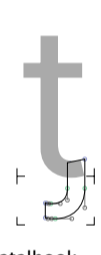
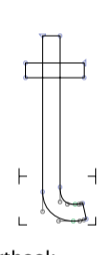
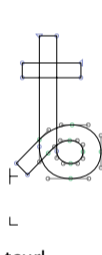
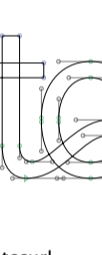
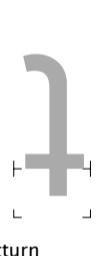
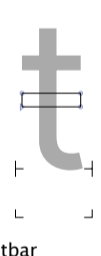
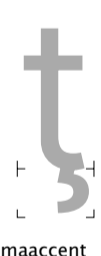
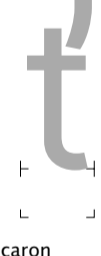

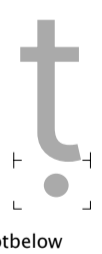



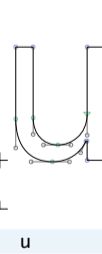

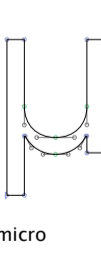

ó ocircumflex omacron obreve ohungarumlaut ocaron

oogonek oogonekmacron odblgrave oinvertedbreve uni022B uni022D

ö uni022F 022F ö uni0231 0231 otildeacute otildedieresis omacrongrave omacronacute

odotbelow ohookabove ocircumflexacute ocircumflexgrave ocircumflexhookabove ocircumflextilde

					
ocircumflexdotbelow 1ED9	ohornacute 1EDB	ohorngrave 1EDD	ohornhookabove 1EDF	ohorntilde 1EE1	ohorndotbelow 1EE3
					
oslashacute 01FF	omicron 03BF	omicrontonos 03CC	uni1F40 1F40	uni1F41 1F41	uni1F42 1F42
					
uni1F43 1F43	uni1F44 1F44	uni1F45 1F45	uni1F78 1F78	fitacyrillic 0473	obar 0275
					
ocyrillic 043E	odieresiscyrillic 04E7	oe 0153	ukcyrillic 0479	p 0070	uni048F 048F
					
phook 01A5	pacute 1E55	pdotaccent 1E57	ercyrillic 0440	q 0071	qhook 02A0
					
qrhook 024B	Q_rhook 024A	r 0072	rrhook 027D	uni024D 024D	rturn 0279
					
rturnrhook 027B	rfishhookrev 027F	rfishhook 027E	rdescend 027C	racute 0155	rcommaaccent 0157
					
rcaron 0159	rdblgrave 0211	rinvertedbreve 0213	rdotaccent 1E59	rdotbelow 1E5B	rdotbelowmacron 1E5D
					
rlinebelow 1E5F	r.1	rrhook.1	uni024D.1	rdescend.1	racute.1

					
rcommaaccent.1	rcaron.1	rdblgrave.1	rinvetdbreve.1	rdotaccent.1	rdotbelow.1
					
rdotbelowmacron.1	rlinebelow.1	s 0073	srthook 0282	uni023F 023F	sacute 015B
					
scircumflex 015D	scedilla 015F	scaron 0161	scommaaccent 0219	sdotaccent 1E61	sdotbelow 1E63
					
sacutedotaccent 1E65	scarondotaccent 1E67	sdotbelowdotaccent 1E69	dzecyrillic 0455	tonetwo 01A8	germandbls 00DF
					
germandbls.1	t 0074	tpalatalhook 01AB	trthook 0288	tcurl 0236	tccurl 02A8
					
tturn 0287	tbar 0167	tcommaaccent 0163	tcaron 0165	uni021B 021B	tdotaccent 1E6B
					
tdotbelow 1E6D	tlinebelow 1E6F	tcircumflexbelow 1E71	tdieresis 1E97	u 0075	udieresis 00FC
					
utilde 0169	uhorn 01B0	micro 00B5	ubar 0289	ugrave 00F9	uacute 00FA
					
ucircumflex 00FB	umacron 016B	ubreve 016D	uring 016F	uhungarumlaut 0171	uogonek 0173



ucaron 01D4



udieresis macron 01D6



udieresis acute 01D8



udieresis caron 01DA



udieresis grave 01DC



udblgrave 0215



uinverted breve 0217



udieresis below 1E73



utilde below 1E75



ucircumflex below 1E77



utilde acute 1E79



umacron dieresis 1E7B



udot below 1EE5



uhook above 1EE7



uhorn acute 1EE9



uhorn grave 1EEB



uhorn hook above 1EED



uhorn tilde 1EEF



uhorn dot below 1EF1

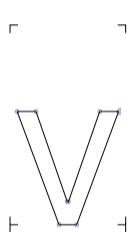

v 0076



vturn 028C



vtilde 1E7D



vdot below 1E7F



w 0077



wdieresis 1E85



wturn 028D



wcircumflex 0175



wgrave 1E81



wacute 1E83



wdot accent 1E87



wdot below 1E89



wring 1E98



x 0078



xdot accent 1E8B



xdieresis 1E8D



khacyrillic 0445

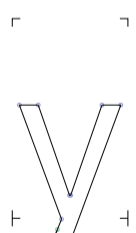

y 0079



ydieresis 00FF

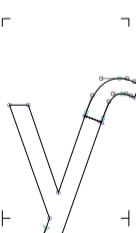

yhook 01B4

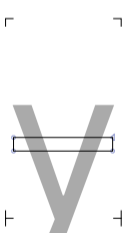

uni024F 024F



yacute 00FD



ycircumflex 0177



uni0233 0233



ydot accent 1E8F



yring 1E99



ygrave 1EF3



ydot below 1EF5



yhook above 1EF7



ytilde 1EF9



ucyrillic 0443



ushort cyrillic 045E













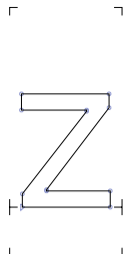

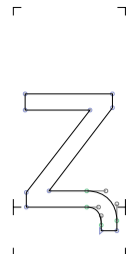
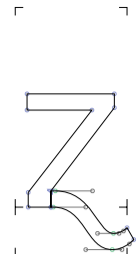







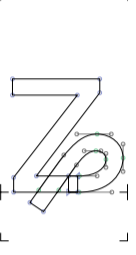
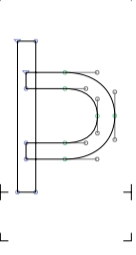
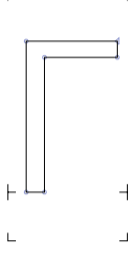
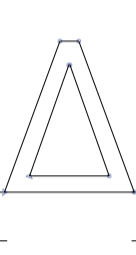
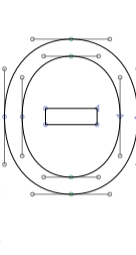
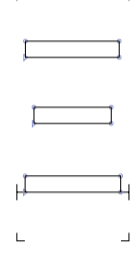
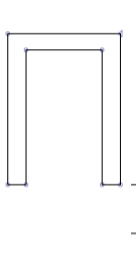
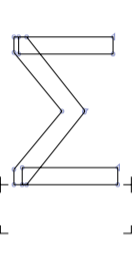
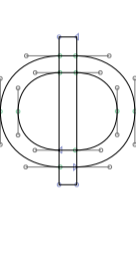
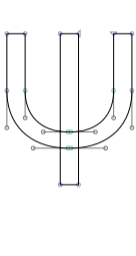
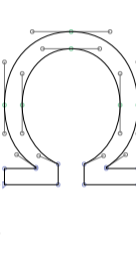













umacron cyrillic 04EF



udieresis cyrillic 04F1

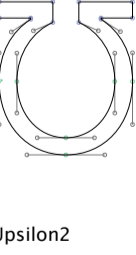
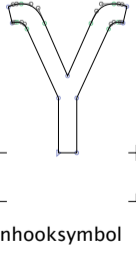

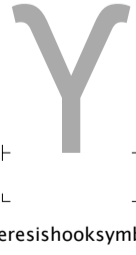
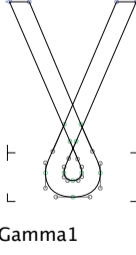
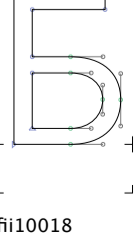
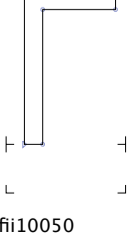
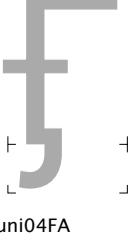
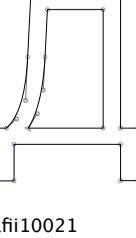
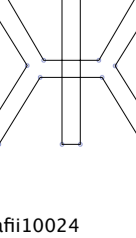
uhungarumlaut cyrillic 04F3

					
yturn 028E	z 007A	zbar 01B6	zhook 0225	uni0240 0240	zrthook 0290
					
zacute 017A	zdotaccent 017C	zcaron 017E	zcircumflex 1E91	zdotbelow 1E93	zlinebelow 1E95
					
zcurl 0291	Thorn 00DE	Gamma 0393	Delta 0394	Theta 0398	Xi 039E
					
Pi 03A0	Sigma 03A3	Phi 03A6	Psi 03A8	Omega 03A9	uni1FFB 1FFB
					
Omegatonos 038F	uni1F68 1F68	uni1F69 1F69	uni1F6A 1F6A	uni1F6B 1F6B	uni1F6C 1F6C
					
uni1F6D 1F6D	uni1F6E 1F6E	uni1F6F 1F6F	uni1FFA 1FFA	uni1FA8 1FA8	uni1FA9 1FA9
					
uni1FAA 1FAA	uni1FAB 1FAB	uni1FAC 1FAC	uni1FAD 1FAD	uni1FAE 1FAE	uni1FAF 1FAF
					
uni1FFC 1FFC	Upsilon2 01B1	Upsilonhooksymbol 03D2	Upsilonacutehookssymbolgre 03D3	Upsilondieresishookssymbol 03D4	Gamma1 0194
					
afii10018 0411	afii10050 0490	uni04FA 04FA	afii10021 0414	afii10024 0416	Zhedescendercyrillic 0496



afii10025 0417

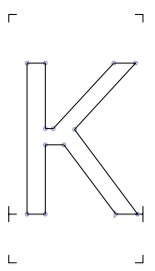

Kacyr 041A

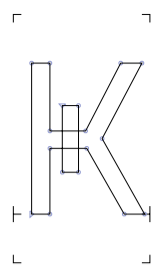

Kavertikalstrokeycyrillic 049C

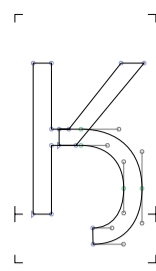

Kahookcyrillic 04C3

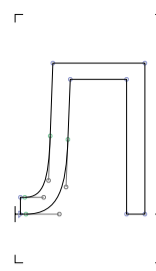

afii10029 041B

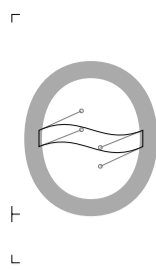

afii10147 0472

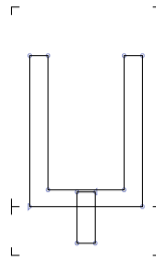

afii10145 040F

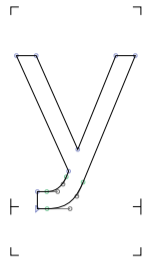

afii10037 0423

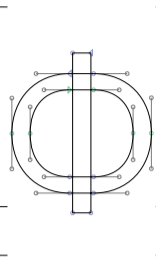

afii10038 0424

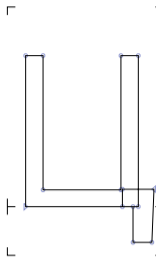

afii10040 0426

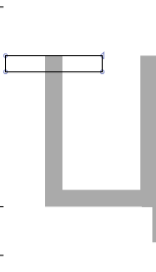

Tetsecyrillic 0484

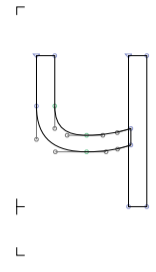

afii10041 0427



Chedescendercyrillic 04B6

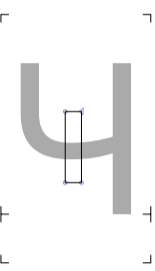

Cheverticalstrokeycyrillic 04B8



Shhacyrillic 04BA

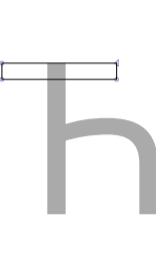

afii10060 040B

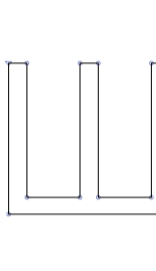

afii10042 0428



afii10043 0429



afii10044 042A



afii10045 042B

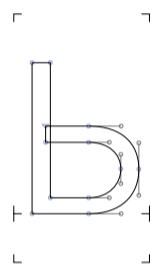

afii10046 042C

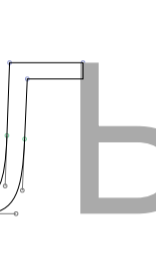

afii10058 0409

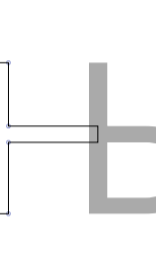

afii10059 040A

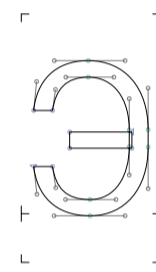

afii10047 042D



afii10048 042E



afii10049 042F



Ghemiddlehookcyrillic 0494



Pemiddlehookcyrillic 04A6

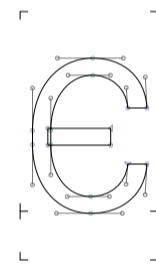

afii10053 0404

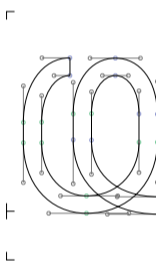

Haabkhasiancyrillic 04A8

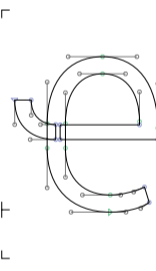

Cheabkhasiancyrillic 04BC

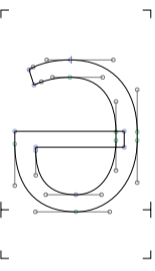

Schwacyrillic 04D8



Dzeabkhasiancyrillic 04E0

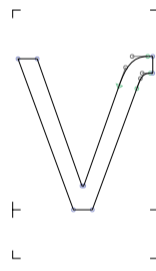

afii10148 0474

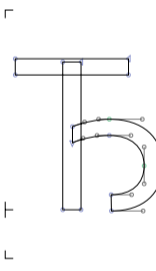

afii10051 0402

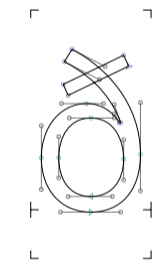

eth 00F0

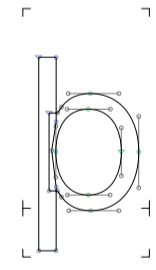

thorn 00FE

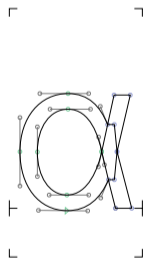

alpha 03B1



alphatonos 03AC

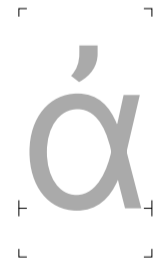

uni1F00 1F00

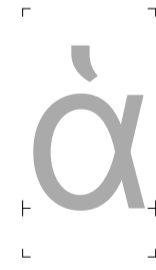

uni1F01 1F01



uni1F02 1F02

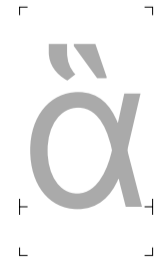

uni1F03 1F03



uni1F04 1F04

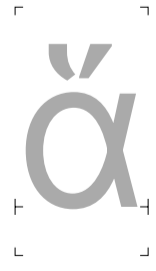

uni1F05 1F05

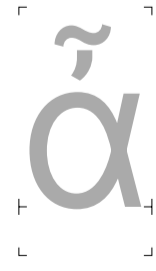

uni1F06 1F06



uni1F07 1F07

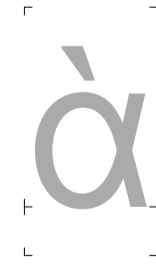

uni1F70 1F70

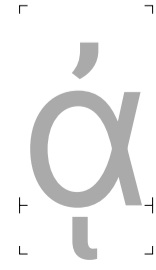

uni1F80 1F80

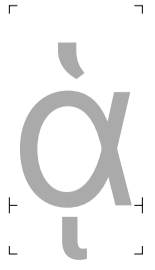

uni1F81 1F81

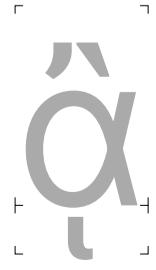

uni1F82 1F82

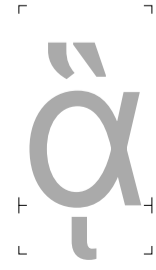

uni1F83 1F83

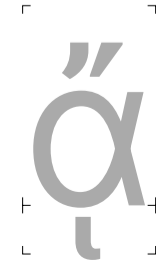

uni1F84 1F84

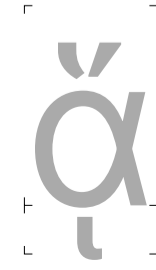

uni1F85 1F85



uni1F86 1F86



uni1F87 1F87



uni1F80 1F80



uni1F81 1F81

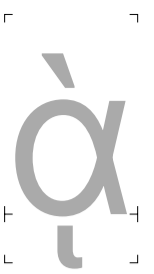

uni1F82 1F82



uni1F83 1F83

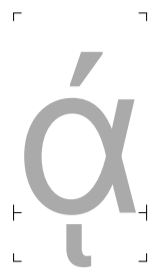

uni1F84 1F84

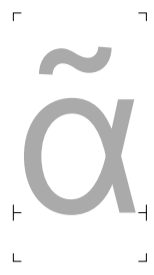

uni1F86 1F86



uni1F87 1F87

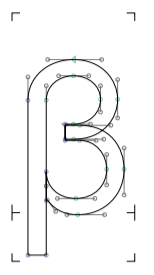

beta 03B2

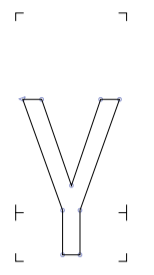

gamma 03B3

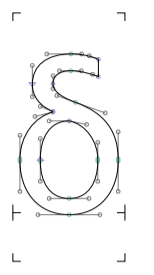

delta 03B4

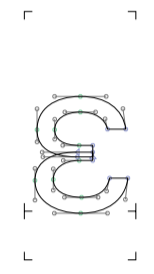

epsilon 03B5

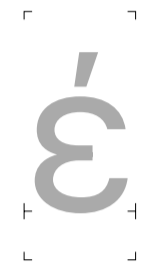

epsilonontonos 03AD

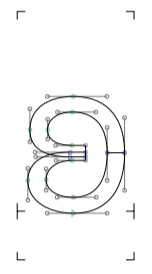

epsilonclosed 029A



epsilon1 025B



epsilon1rev 025C

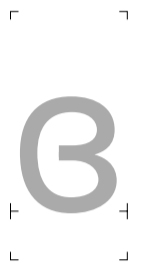

epsilon1revclosed 025E

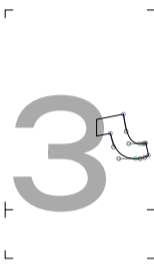

epsilon1revhook 025D

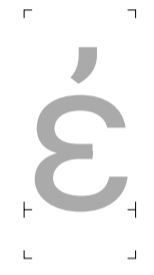

uni1F10 1F10



uni1F11 1F11

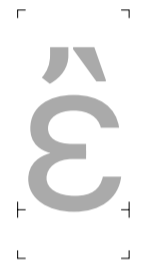

uni1F12 1F12



uni1F13 1F13



uni1F14 1F14



uni1F15 1F15

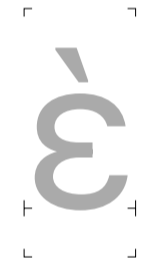

uni1F72 1F72

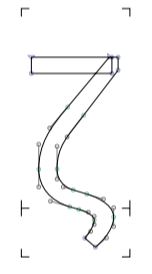

zeta 03B6

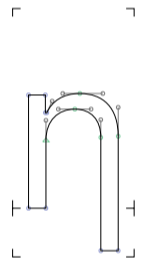

eta 03B7

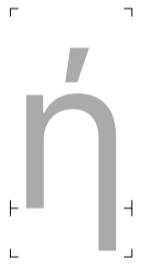

etatonos 03AE



uni1F20 1F20



uni1F21 1F21

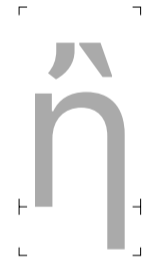

uni1F22 1F22



uni1F23 1F23



uni1F24 1F24

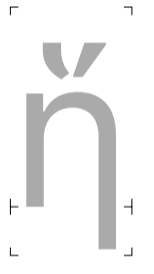

uni1F25 1F25



uni1F26 1F26



uni1F27 1F27

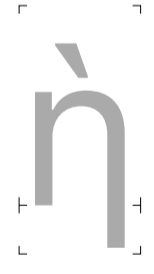

uni1F74 1F74



uni1F90 1F90



uni1F91 1F91

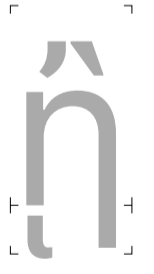

uni1F92 1F92

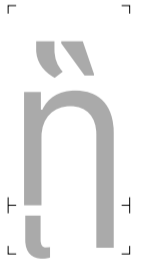

uni1F93 1F93



uni1F94 1F94



uni1F95 1F95



uni1F96 1F96



uni1F97 1F97

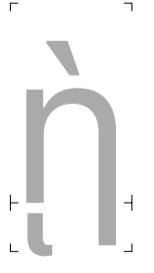

uni1FC2 1FC2



uni1FC3 1FC3

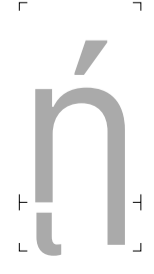

uni1FC4 1FC4



uni1FC6 1FC6



uni1FC7 1FC7

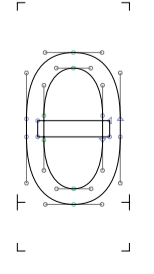

theta 03B8

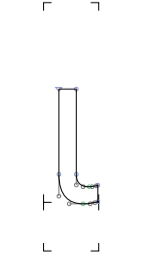

iota 03B9

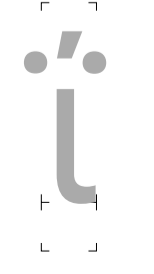

iotadierestonos 0390



iotatonos 03AF



iotadieresis 03CA



uni1F30 1F30



uni1F31 1F31



uni1F32 1F32



uni1F33 1F33



uni1F34 1F34



uni1F35 1F35



uni1F36 1F36



uni1F37 1F37



uni1F76 1F76



uni1FD0 1FD0



uni1FD1 1FD1



uni1FD2 1FD2



uni1FD6 1FD6



uni1FD7 1FD7



lambda 03BB

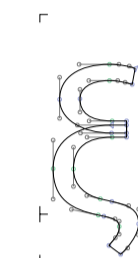

xi 03BE

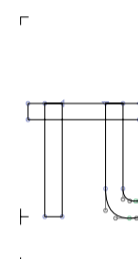

pi 03C0

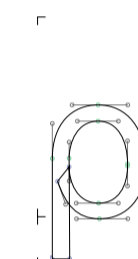

rho 03C1



uni1FE4 1FE4



uni1FE5 1FE5



uni03FC 03FC

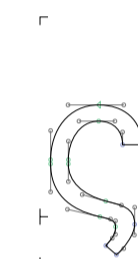

sigma1 03C2

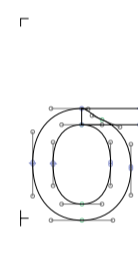

sigma 03C3

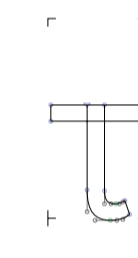

tau 03C4

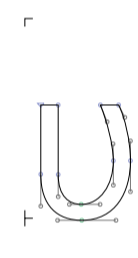

upsilon 03C5



upsilondieresis 03B0



upsilondieresis 03CB



upsilon 03CD



uni1F50 1F50



uni1F51 1F51



uni1F52 1F52



uni1F53 1F53



uni1F54 1F54



uni1F55 1F55



uni1F56 1F56



uni1F57 1F57



uni1F7A 1F7A



uni1FE0 1FE0



uni1FE1 1FE1



uni1FE2 1FE2



uni1FE6 1FE6



uni1FE7 1FE7

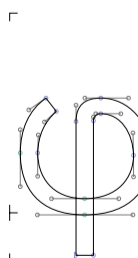

phi 03C6

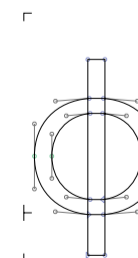

phigreek 03D5

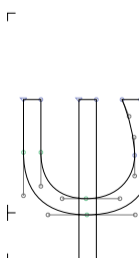

psi 03C8

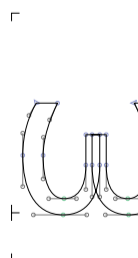

omega 03C9



omegatonos 03CE



uni1F60 1F60



uni1F61 1F61



uni1F62 1F62



uni1F63 1F63



uni1F64 1F64

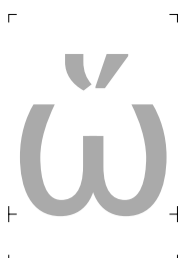

uni1F65 1F65

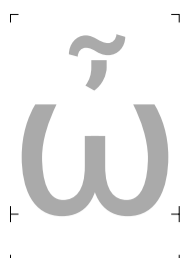

uni1F66 1F66

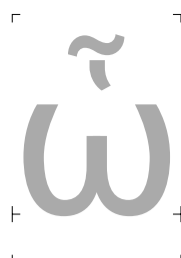

uni1F67 1F67

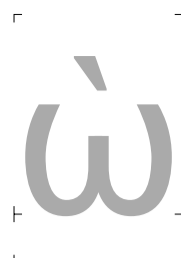

uni1F7C 1F7C

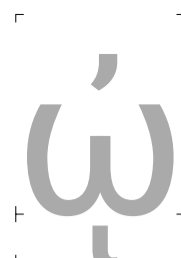

uni1FA0 1FA0

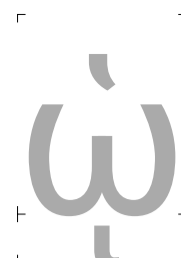

uni1FA1 1FA1

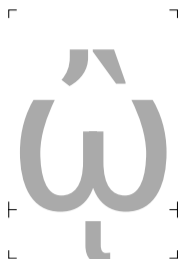

uni1FA2 1FA2

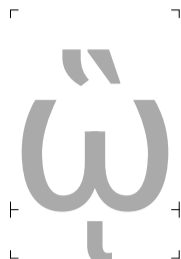

uni1FA3 1FA3

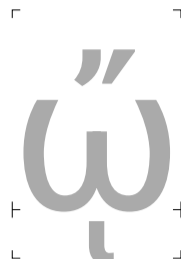

uni1FA4 1FA4

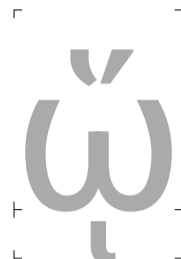

uni1FA5 1FA5

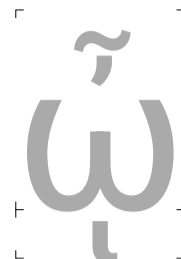

uni1FA6 1FA6

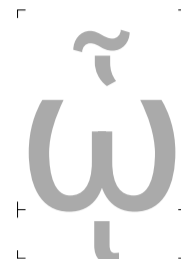

uni1FA7 1FA7



uni1FF2 1FF2



uni1FF3 1FF3



uni1FF4 1FF4



uni1FF6 1FF6



uni1FF7 1FF7

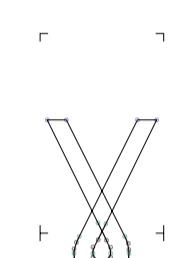

gamma1 0263

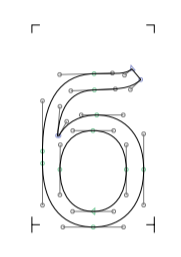

becyrillic 0431

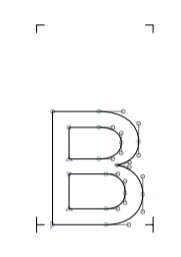

vecyrillic 0432

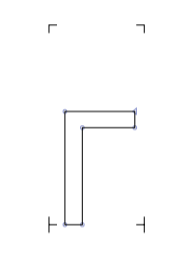

gecyrillic 0433

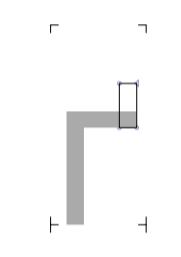

gheupturncyrillic 0491



uni04FB 04FB

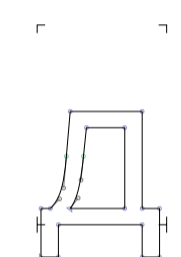

decyrillic 0434

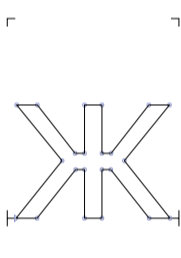

zhecyrillic 0436



zhedescendercyrillic 0497

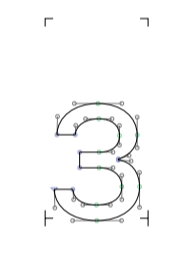

zecyrillic 0437

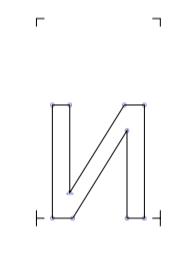

iicyrillic 0438



uni048B 048B

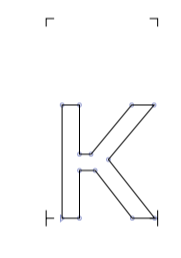

kacyrillic 043A

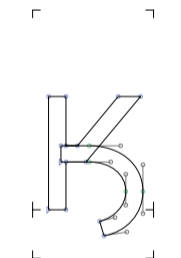

kahookcyrillic 04C4

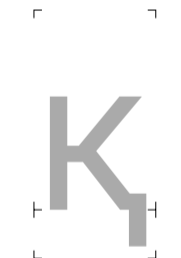

kadescendercyrillic 049B

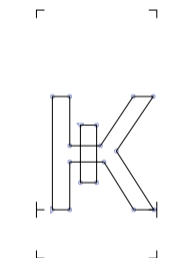

kaverticastrokecyrillic 049D

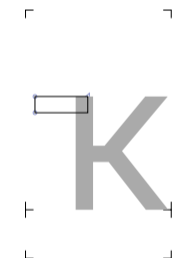

kabashkircyrillic 04A1

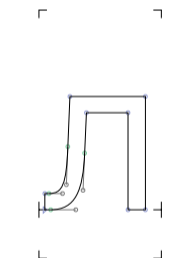

elcyrillic 043B

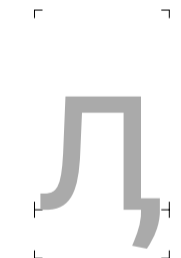

uni04C6 04C6

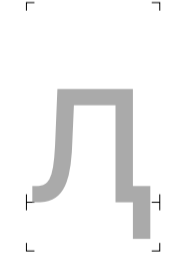

uni052F 052F

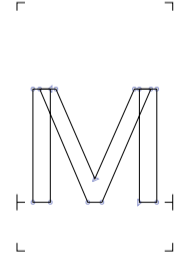

emcyrillic 043C



uni04CE 04CE

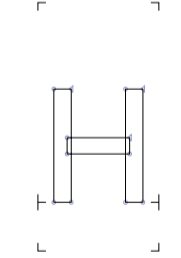

encyrillic 043D

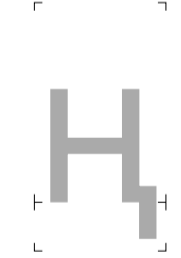

endescendercyrillic 04A3

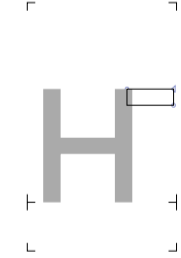

enghecyrillic 04A5

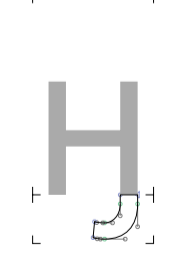

enhookcyrillic 04C8

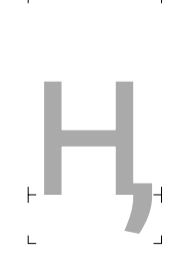

uni04CA 04CA

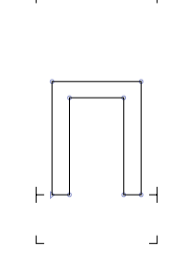

pecyrillic 043F

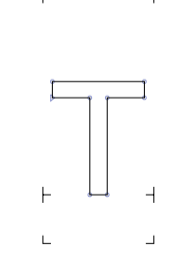

tecyrillic 0442

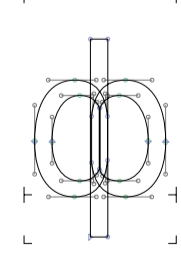

efcyrillic 0444

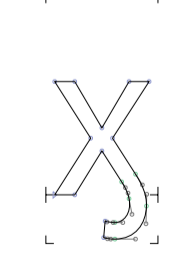

uni04FD 04FD

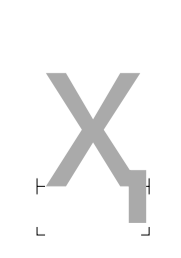

hadescendercyrillic 04B3

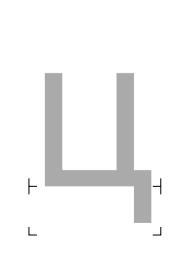

tsecyrillic 0446

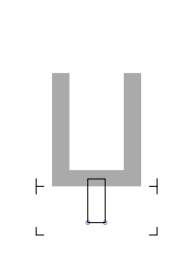

dzhecyrillic 045F

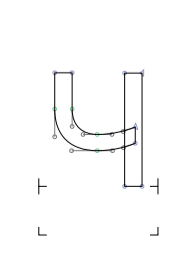

checyrillic 0447

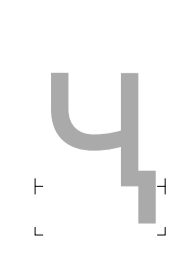

chedescendercyrillic 04B7

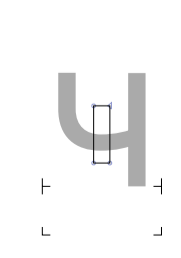

cheverticalstrokecyrillic 04B9

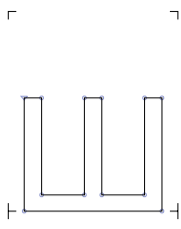

shacyrillic 0448

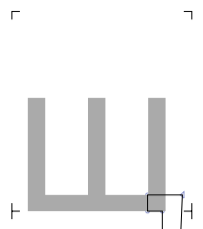

shchacyrillic 0449

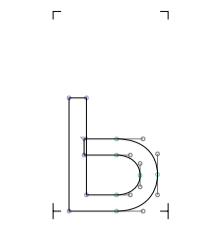

softsigncyrillic 044C

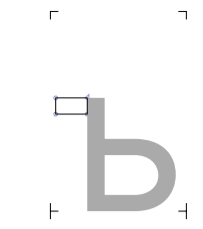

hardsigncyrillic 044A



yeryrillic 044B

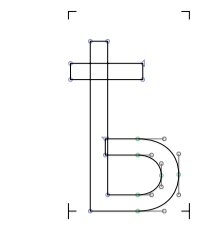

uni048D 048D

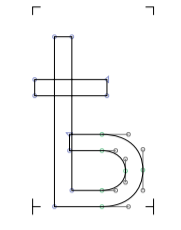

yacyrillic 0463

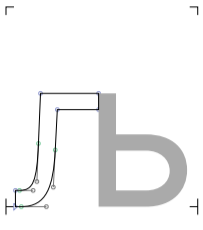

ljcyrillic 0459

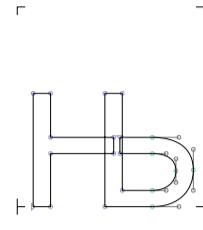

njcyrillic 045A

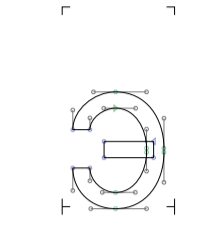

ereversedcyrillic 044D

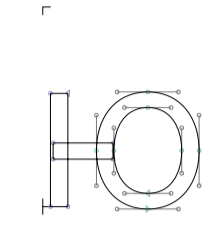

iucyrillic 044E

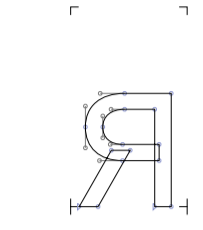

iacyrillic 044F

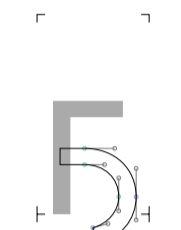

ghemiddlehookcyrillic 0495

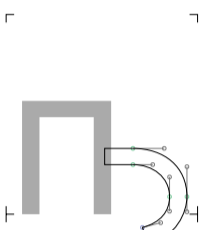

pemiddlehookcyrillic 04A7

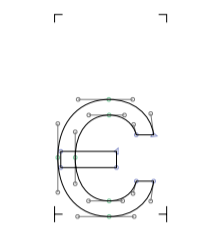

ecyrillic 0454

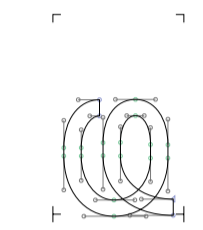

haabkhasiancyrillic 04A9

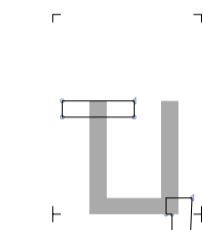

tetsecyrillic 04B5

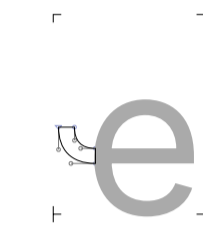

cheabkhasiancyrillic 04BD



dzeabkhasiancyrillic 04E1

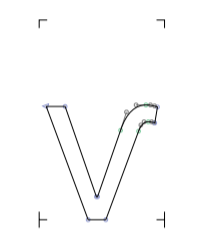

izhitsacyrillic 0475

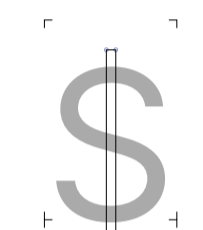

dollar 0024

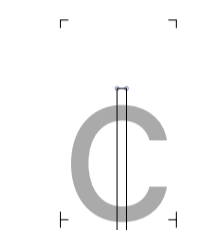

cent 00A2

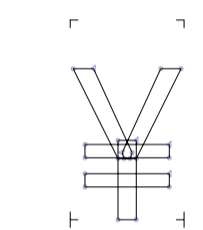

yen 00A5

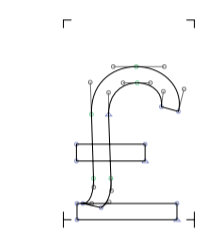

sterling 00A3

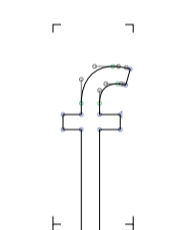

florin 0192

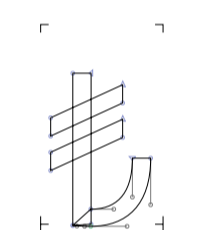

uni20BA 20BA

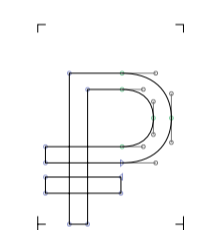

uni20BD 20BD

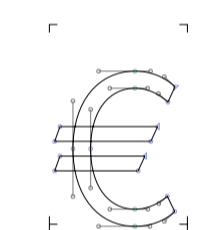

euro 20AC

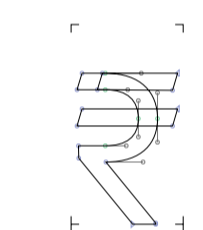

uni20B9 20B9

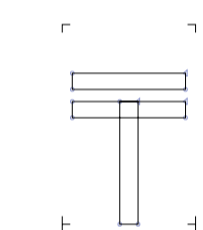

tenge 20B8

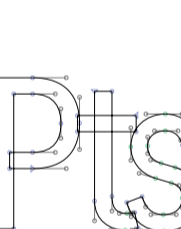

peseta 20A7

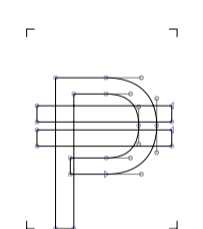

peso 20B1

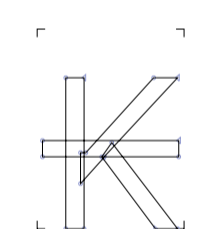

kip 20AD

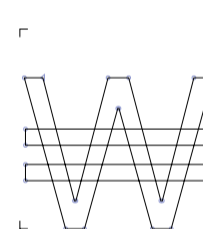

won 20A9

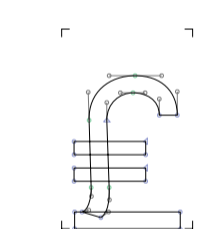

lira 20A4

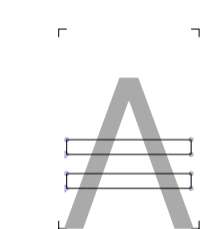

austral 20B3

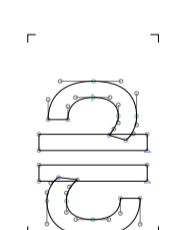

hryvnia 20B4

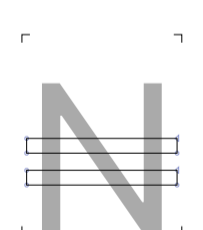

naira 20A6

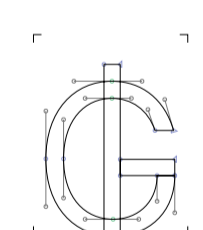

guarani 20B2

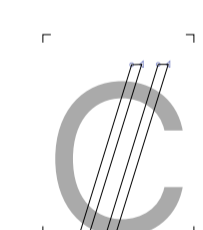

coloncurrenny 20A1

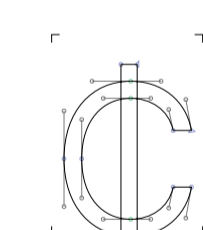

cedi 20B5

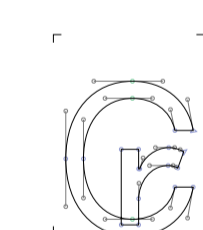

cruzeiro 20A2

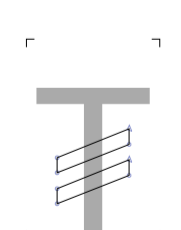

tugrik 20AE

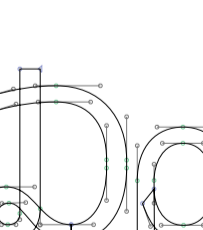

uni20AF 20AF

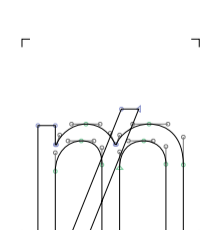

mill 20A5

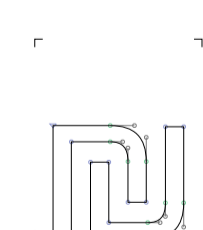

afii57636 20AA

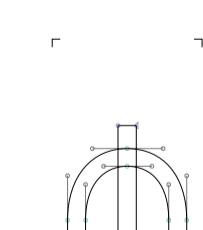

manat 20BC



rupee 20A8

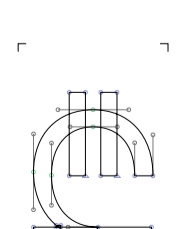

lari 20BE

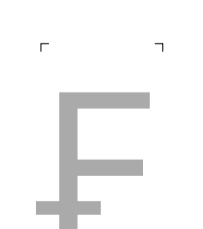

franc 20A3

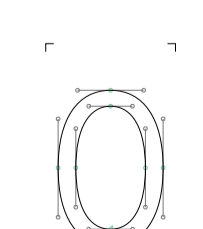

zero 0030

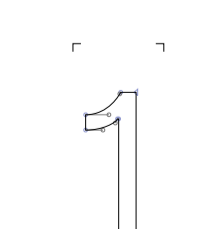

one 0031

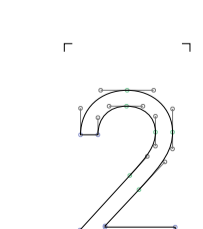



two 0032



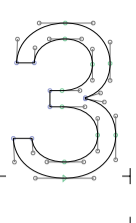
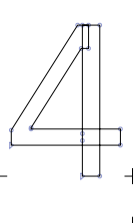
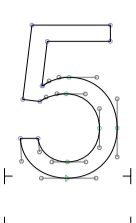
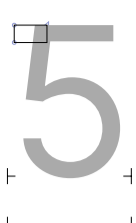
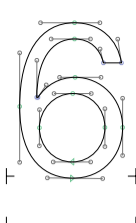
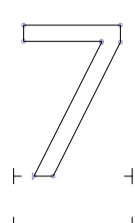

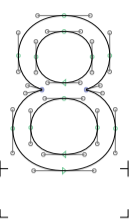
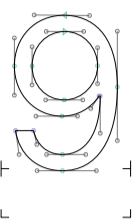
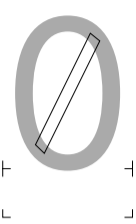
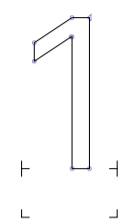
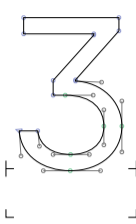
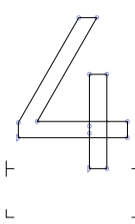

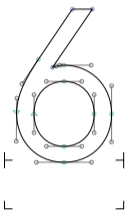
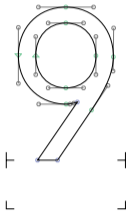
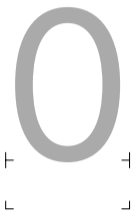
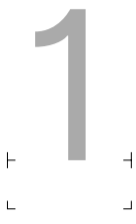



twostroke 01BB

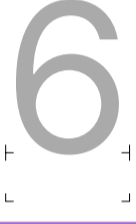
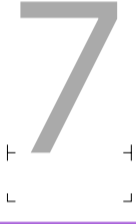
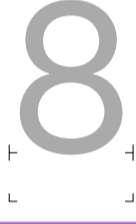

					
three 0033	four 0034	five 0035	Tonefive 01BC	six 0036	seven 0037

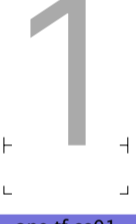

					
eight 0038	nine 0039	zero.slash	one.ss01	three.1	four.ss01

					
six.ss01	nine.ss01	zero.tf	one.tf	two.tf	three.tf

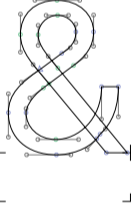
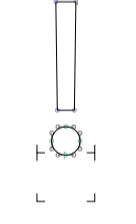
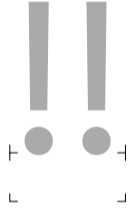
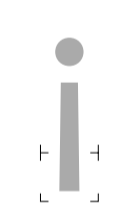
					
four.tf	five.tf	six.tf	seven.tf	eight.tf	nine.tf

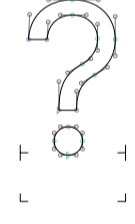



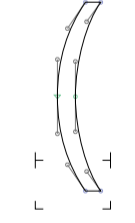

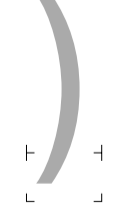
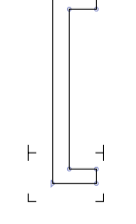
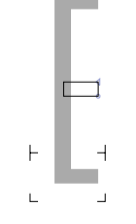
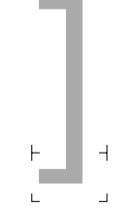
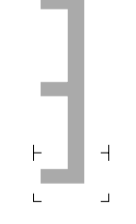
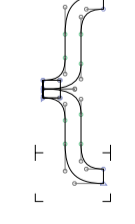

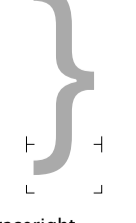
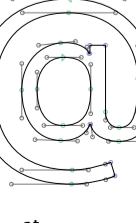
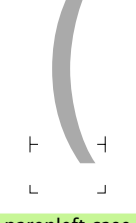
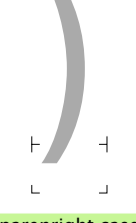
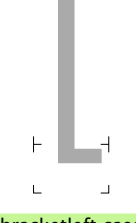
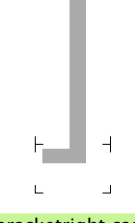



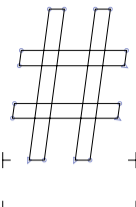
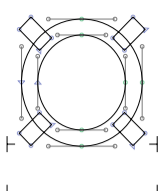

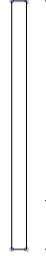

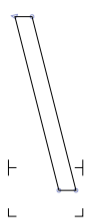



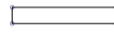
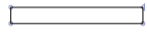
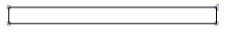

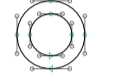

























					
zero.tf.slash	one.tf.ss01	three.1.tf	four.tf.ss01	six.tf.ss01	nine.tf.ss01

					
ampersand 0026	exclam 0021	exclamdbl 203C	exclamdown 00A1	uni2049 2049	question 003F

					
uni2047 2047	uni2048 2048	questiondown 00BF	interrobang 203D	invertedinterrobang 2E18	parenleft 0028

					
parenright 0029	bracketleft 005B	bracketleft_quill 2045	bracketright 005D	bracketright_quill 2046	braceleft 007B

					
bracerright 007D	at 0040	parenleft.case	parenright.case	bracketleft.case	bracketright.case

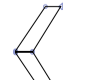
					
braceleft.case	braceright.case	at.case	numersign 0023	currency 00A4	slash 002F
					
bar 007C	brokenbar 00A6	backslash 005C	hyphenbullet 2043	hyphen 002D	softhyphen 00AD
					
endash 2013	figuredash 2012	emdash 2014	horizontalbar 2015	bullet 2022	openbullet 25E6
					
hyphen.case	endash.case	figuredash.case	emdash.case	bullet.case	openbullet.case
					
quotelleft 2018	quoteright 2019	apostrophemod 02BC	quotesingle 0027	quotedbl 0022	quotedblleft 201C
					
quotedblright 201D	quotedblbase 201E	quotesinglbase 201A	prime 2032	doubleprime 2033	tripleprime 2034
					
quadrupleprime 2057	primerev 2035	doubleprimerev 2036	tripleprimerev 2037	primemod 02B9	doubleprimemod 02BA
					
comma 002C	period 002E	ellipsis 2026	twodotleader 2025	colon 003A	colon.case
					
semicolon 003B	comma.tf	period.tf	colon.tf	semicolon.tf	guilsinglleft 2039

guilsingright 203A	guillemetleft 00AB	guillemetright 00BB	less 003C	greater 003E	lessequal 2264
greaterequal 2265	equal 003D	notequal 2260	plus 002B	minus 2212	multiply 00D7
divide 00F7	plusminus 00B1	aproxequal 2248	asciitilde 007E	less.case	greater.case
lessequal.case	greaterequal.case	equal.case	notequal.case	plus.case	minus.case
multiply.case	divide.case	plusminus.case	aproxequal.case	asciitilde.case	logicalnot 00AC
periodcentered 00B7	anoteleia 0387	questiongreek 037E	underscore 005F	dagger 2020	daggerdbl 2021
asciicircum 005E	asterisk 002A	asterisk.case	registered 00AE	trademark 2122	servicemark 2120
degree 00B0	ordfeminine 00AA	ordmasculine 00BA	i.numr	n.numr	paragraph 00B6
section 00A7	copyright 00A9	infinity 221E	partialdiff 2202	summation 2211	product 220F

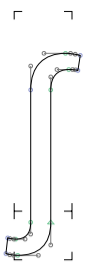

integral 222B

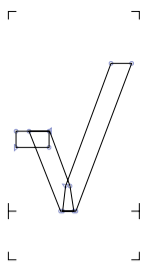

radical 221A

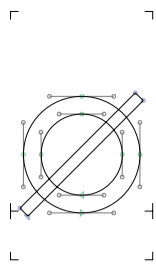

emptyset 2205

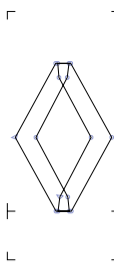

lozenge 25CA

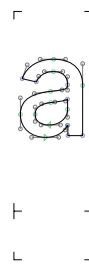

a.sups 1D43

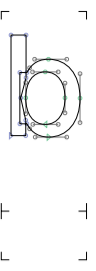

b.sups 1D47

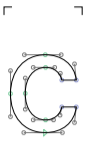

c.sups 1D9C

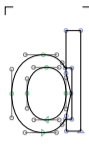

d.sups 1D48

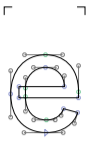

e.sups 1D49



f.sups 1DA0

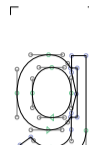

g.sups 1D4D

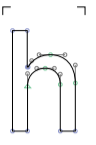

h.sups 02B0



i.sups 2071



j.sups 02B2

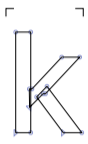

k.sups 1D4F

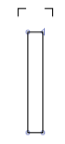

l.sups 02E1

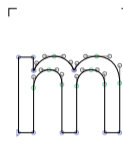

m.sups 1D50

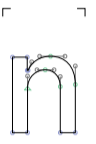

n.sups 207F

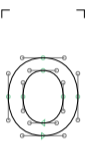

o.sups 1D52

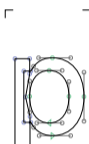

p.sups 1D56

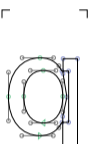

q.sups 146B

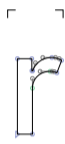

r.sups 02B3

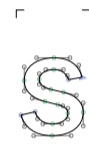

s.sups 02E2

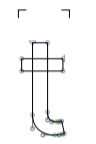

t.sups 1D57

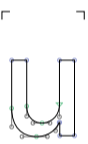

u.sups 1D58



v.sups 1D5B



w.sups 02B7



x.sups 02E3



y.sups 02B8



z.sups 1D8B

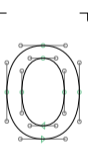

zero.sups 2070



one.sups 00B9

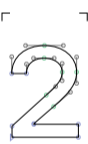

two.sups 00B2

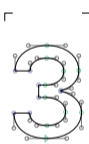

three.sups 00B3

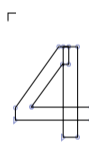

four.sups 2074

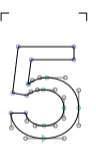

five.sups 2075

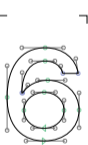

six.sups 2076



seven.sups 2077

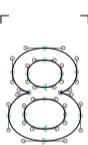

eight.sups 2078

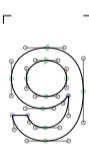

nine.sups 2079



parenleft.sups 207D



parenright.sups 207E

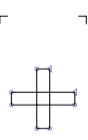

plus.sups 207A



minus.sups 207B

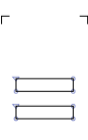

equal.sups 207C



a.subs 2090



b.subs



c.subs



d.subs

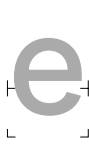

e.subs 2091



f.subs



g.subs

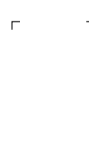

h.subs 2095



i.subs 1D62

j k l m n o

j.subs 2C7C k.subs 2096 l.subs 2097 m.subs 2098 n.subs 2099 o.subs 2092

p q r s t u

p.subs 209A q.subs r.subs 1D63 s.subs 209B t.subs 209C u.subs 1D64

v w x y z 0

v.subs 1D65 w.subs x.subs 2093 y.subs z.subs zero.subs 2080

1 2 3 4 5 6

one.subs 2081 two.subs 2082 three.subs 2083 four.subs 2084 five.subs 2085 six.subs 2086

7 8 9 () +

seven.subs 2087 eight.subs 2088 nine.subs 2089 parenleft.subs 208D parenright.subs 208E plus.subs 208A

- = 0 1 2 3

minus.subs 208B equal.subs 208C zero.dnomf one.dnomf two.dnomf three.dnomf

4 5 6 7 8 9

four.dnomf five.dnomf six.dnomf seven.dnomf eight.dnomf nine.dnomf

/ 0 1 2 3 4

fraction 2044 zero.dnom one.dnom two.dnom three.dnom four.dnom

5 6 7 8 9 +

five.dnom six.dnom seven.dnom eight.dnom nine.dnom plus.dnom

minus.dnom	equal.dnom	parenleft.dnom	parenright.dnom	zero.numr	one.numr

two.numr	three.numr	four.numr	five.numr	six.numr	seven.numr

eight.numr	nine.numr	plus.numr	minus.numr	equal.numr	parenleft.numr

parenright.numr	zero.frac	one.frac	two.frac	three.frac	four.frac











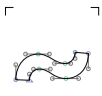

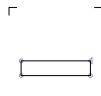
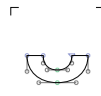

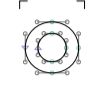
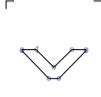
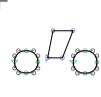





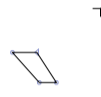
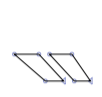
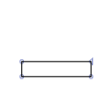

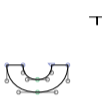

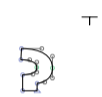







five.frac	six.frac	seven.frac	eight.frac	nine.frac	onehalf 00BD

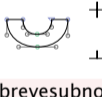

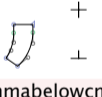
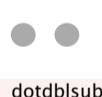
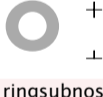
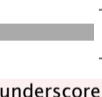
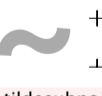
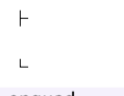
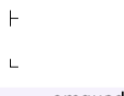
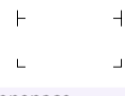
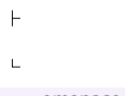
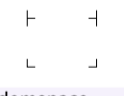
onequarter 00BC	threequarters 00BE	fivesixths 215A	onefraction 215F	seveneighths 215E	oneeighth 215B

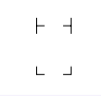
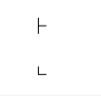
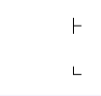
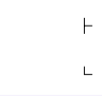
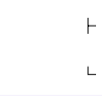

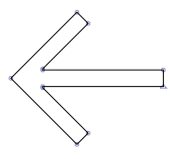
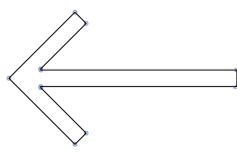
fiveeighths 215D	threeeighths 215C	percent 0025	perthousand 2030	pertenthousand 2031	uni214D 214D

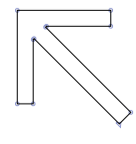
cadauna 2106	careof 2105	accountof 2100	addresssubject 2101	numero 2116	acute 00B4

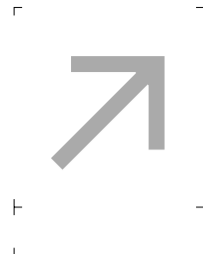
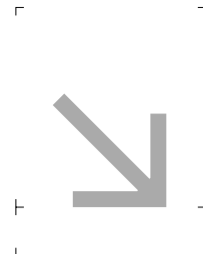
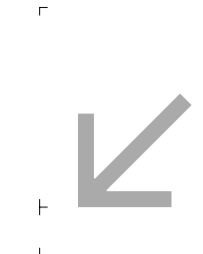
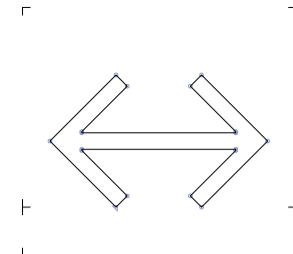
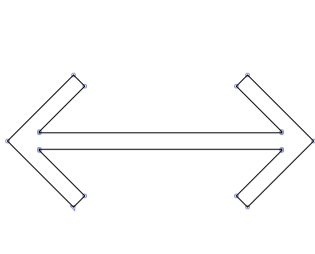
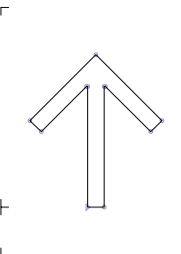
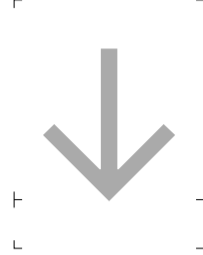
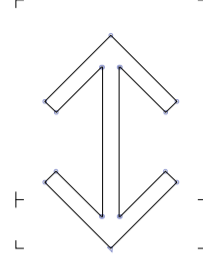
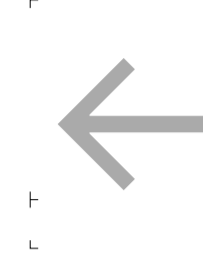
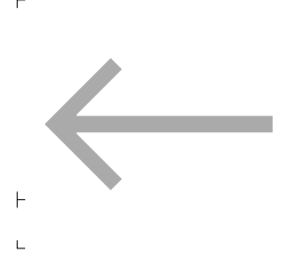
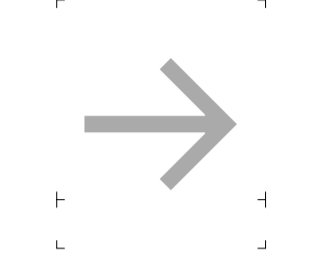
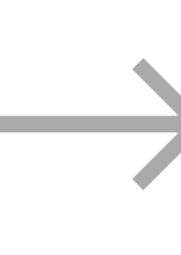
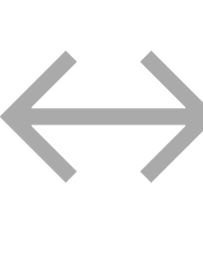
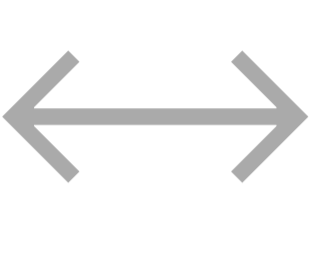
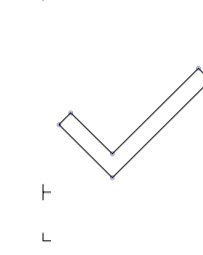
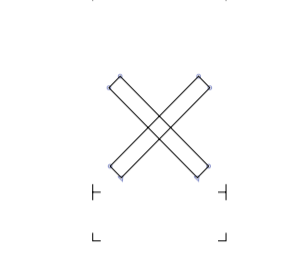
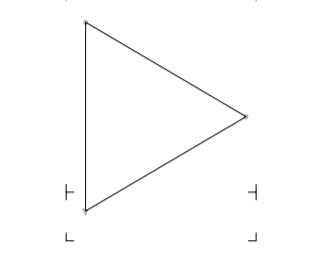
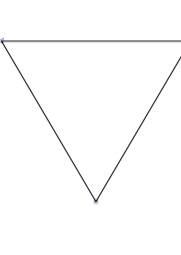
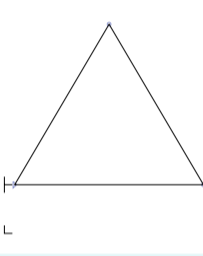
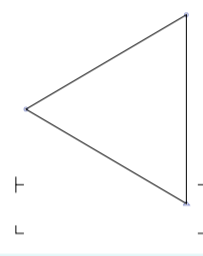
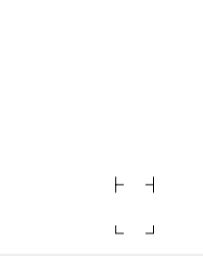
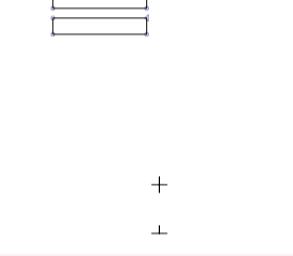
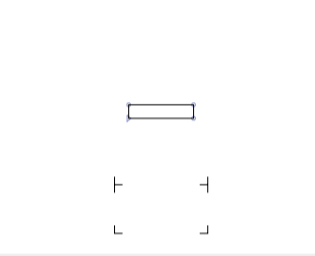
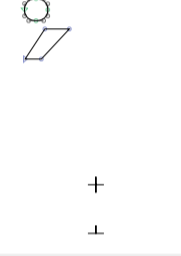
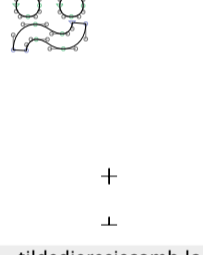
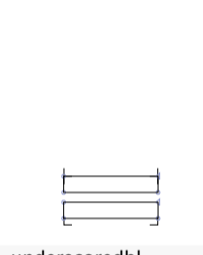
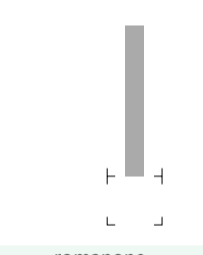
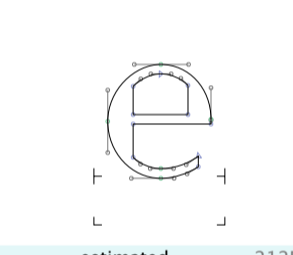
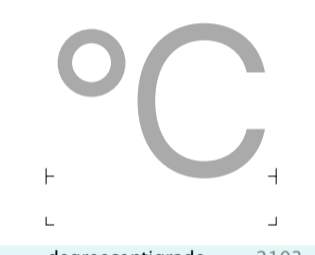
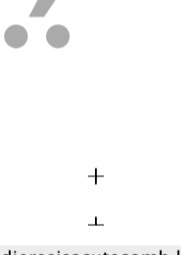
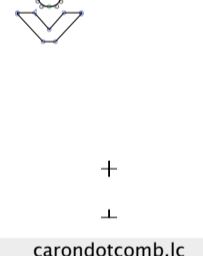
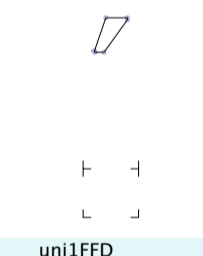
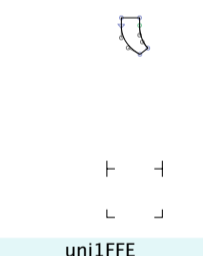
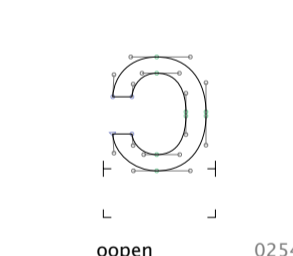
hungarumlaut 02DD	grave 0060	tonos 0384	dieresis 00A8	casedieresis.cn	circumflex 02C6

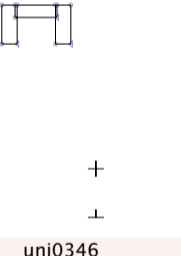
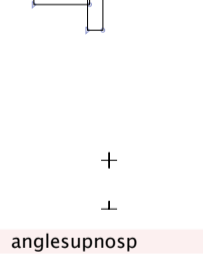
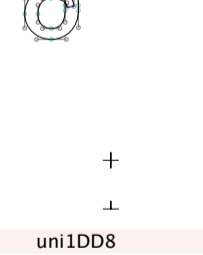
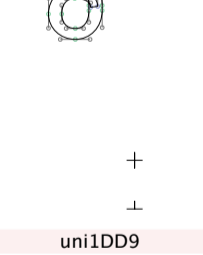
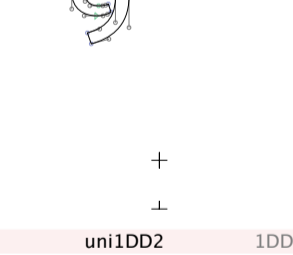
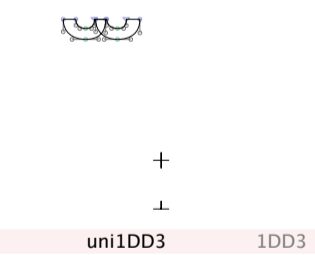
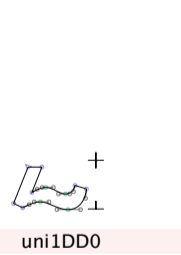
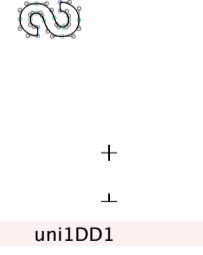
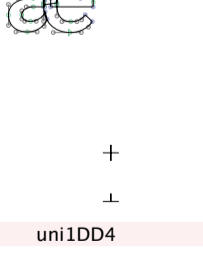
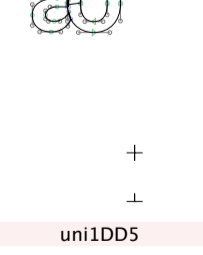
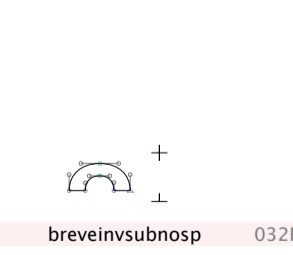
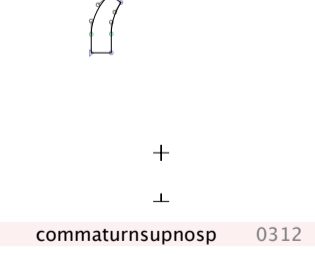
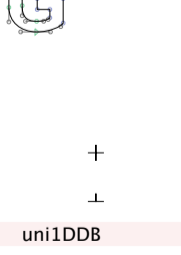
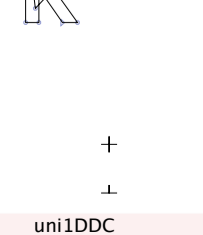
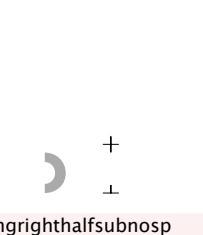
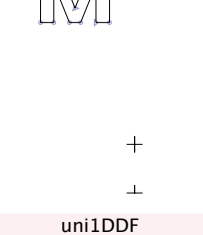
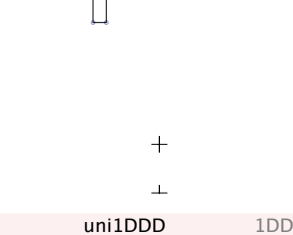
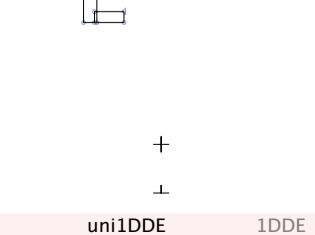
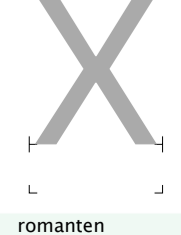
					
tilde 02DC	casetilde.cn	macron 00AF	breve 02D8	cyrillicbreve	dotaccent 02D9
					
ring 02DA	caron 02C7	dieresistonos 0385	cedilla 00B8	ogonek 02DB	commaaccent F6C3
					
acutecomb 0301	acutedblnosp 0308	gravecomb 0300	dblgravecmb 030F	macroncomb 0304	dieresisnosp 0308
					
brevenosp 0306	breveinvnosp 0311	hook 0309	circumflexnosp 0302	caroncmb 030C	tildecomb 0303
					
dotnosp 0307	ringnosp 030A	hornnosp 031B	ogoneknosp 0328	cedillanosp 0327	circumflexsubnosp 032D
					
brevesubnosp 032E	dotbelow 0323	commabelowcmb 0326	dotdblsubnosp 0324	ringsubnosp 0325	underscorenosp 0332
					
tildesubnosp 0330	enquad 2000	emquad 2001	enspace 2002	emspace 2003	thirdemspace 2004
					
quateremspace 2005	sixthemspace 2006	figurespace 2007	punctuationspace 2008	thinspace 2009	hairspace 200A
					
zerowidthspace 200B	leftArrow 2190	leftLongArrow 27F5	rightArrow 2192	rightLongArrow 27F6	northWestArrow 2196

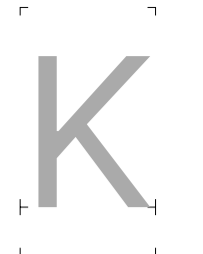
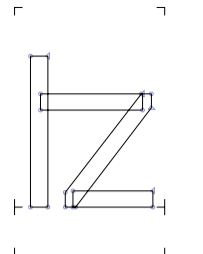
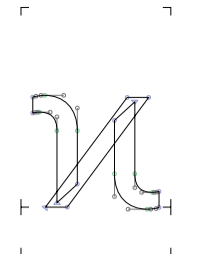
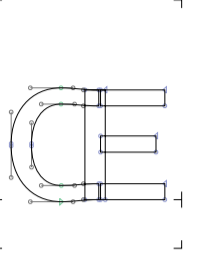
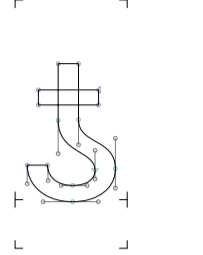
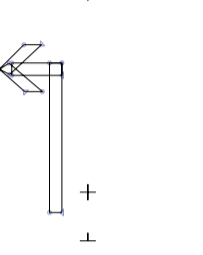
					
northEastArrow 2197	southEastArrow 2198	southWestArrow 2199	leftRightArrow 2194	leftRightLongArrow 27F7	upArrow 2191
					
downArrow 2193	upDownArrow 2195	leftArrow.case	leftLongArrow.case	rightArrow.case	rightLongArrow.case
					
leftRightArrow.case	leftRightLongArrow.case	dngb_check 2713	dngb_ballotx 2717	triagr 258A	triagdn 258C
					
triagup 2582	blackleftpointingtriangle 25C0	uni2009.fra	overscoredbl 033F	crossbar	acutedotcomb.lc
					
tildedieriscomb.lc	underscoredbl 2017	romanone 2160	estimated 212E	degreecentigrade 2103	dierisacutecomb.lc
					
carondotcomb.lc	uni1FFD 1FFD	uni1FFE 1FFE	oopen 0254	Gsmallcaphook 029B	uni0346 0346
					
anglesupnosp 031A	uni1DD8 1DD8	uni1DD9 1DD9	uni1DD2 1DD2	uni1DD3 1DD3	uni1DD0 1DD0
					
uni1DD1 1DD1	uni1DD4 1DD4	uni1DD5 1DD5	breveinvsubnosp 032F	commaturnsupnosp 0312	uni1DD8 1DD8
					
uni1DDC 1DDC	ringrighthalfsubnosp 0339	uni1DDF 1DDF	uni1DDD 1DDD	uni1DDE 1DDE	romanten 2169

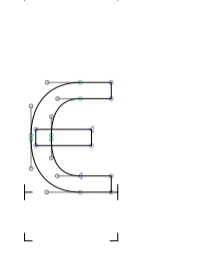
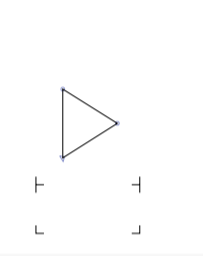
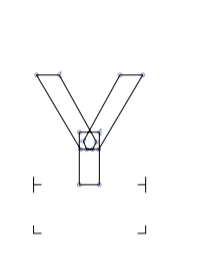
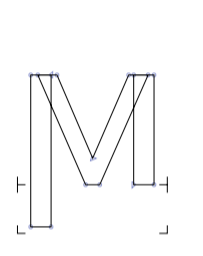
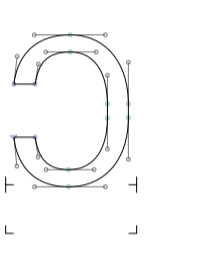
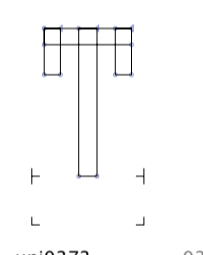
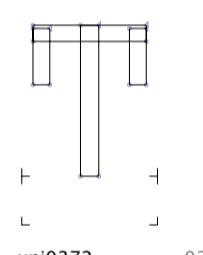
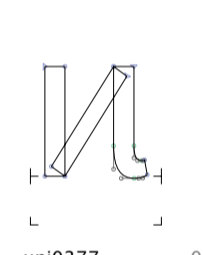
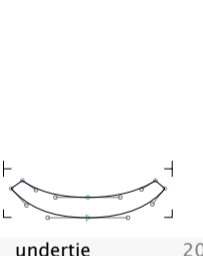
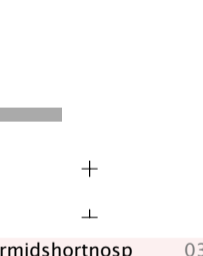
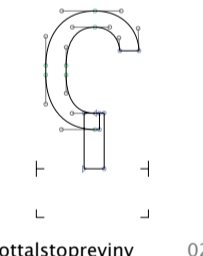
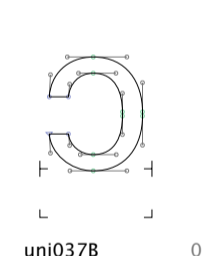
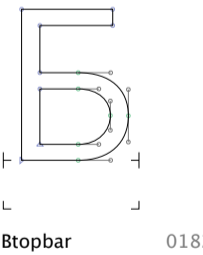
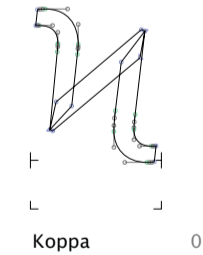
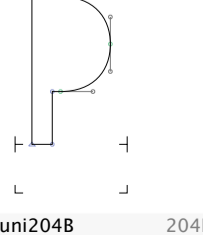
					
degreefahrenheit 2109	degreekelvin 212A	uni02AB 02AB	uni02AC 02AC	uni1FCD 1FCD	kappa1 03F0
					
uni214F 214F	OESmallcap 0276	tackupsubnosp 031D	uni2DFF 2DFF	glottalstopbarinv 018E	seagullsubnosp 033C
					
uni02EC 02EC	afi300 200F	caronnosp	romanfour 2163	uni03F5 03F5	uni03F6 03F6
					
longs 017F	trianglebullet 2023	Ysmallcap 028F	uni03FB 03FB	uni03FD 03FD	uni03FE 03FE
					
uni03FF 03FF	uni0373 0373	uni0372 0372	uni0371 0371	uni0370 0370	uni0377 0377
					
gravesubnosp 0316	undertie 203F	barmidshortnosp 0335	glottalstoppreinv 0295	uni037C 037C	uni037B 037B
					
uni037D 037D	uni213B 213B	erev 0258	cstretch 0297	Btopbar 0182	Koppa 03DE
					
commaturnedmod 02BB	commareversedmod 02BD	ringhalfleft 02BF	Rsmallcap 0280	Tonesix 0184	beta1 03D0
					
uni204F 204F	uni204E 204E	uni204D 204D	uni204C 204C	uni204B 204B	uni204A 204A

CR	slashlongnosp 0338	exclam1 01C3	Digamma 03DC	candrabinunos 0310	qofdagesh 02DF
uni036A 036A	uni036B 036B	uni036C 036C	uni036D 036D	uni036E 036E	uni036F 036F
uni20B7 20B7	uni20B6 20B6	uni20B0 20B0	uni20BB 20BB	tildedoublecmb 0360	breveinverteddoublecmb 0361
uni0362 0362	uni0363 0363	uni0364 0364	uni0365 0365	uni0366 0366	uni0367 0367
uni0368 0368	uni0369 0369	tildemidnosp 0334	uni01F7 01F7	glottalstopinv 0296	acutelowmod 02CF
gravelowmod 02CE	fourthtonechinese 02CB	verticallinelowmod 02CC	secondtonechinese 02CA	romantwelve 216B	uni2183 2183
arrowheadupmod 02C4	arrowheaddownmod 02C5	arrowheadleftmod 02C2	arrowheadrightmod 02C3	glottalstopmod 02C0	firsttonechinese 02C9
uni021D 021D	uni0268.ccmp	uni021C 021C	numeralgreeksub 0375	caronsubnosp	uni205E 205E
uni205A 205A	uni205B 205B	uni205C 205C	schwahook 025A	uni1E9D 1E9D	uni1E9F 1E9F

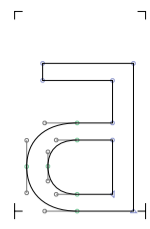

Dtopbar 018B

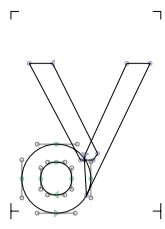

uni1EFE 1EFE

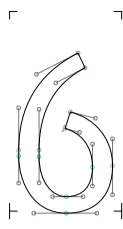

uni1EFD 1EFD

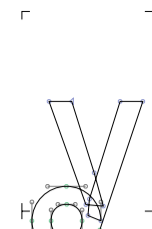

uni1EFF 1EFF



uni1EFA 1EFA

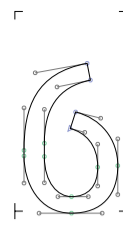

uni1EFC 1EFC

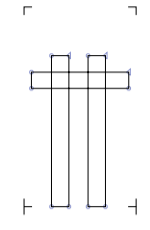

uni1EFB 1EFB

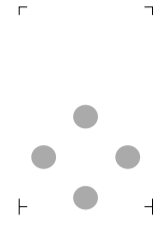

uni2058 2058



uni2059 2059



uni2054 2054

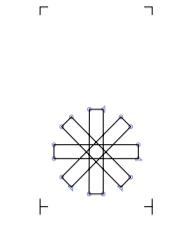

uni2055 2055



uni2056 2056



uni2050 2050



uni2051 2051

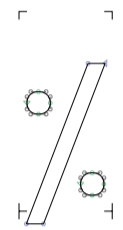

uni2052 2052

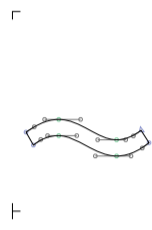

uni2053 2053



ascript_uni02DE

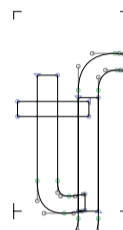

tesh 02A7

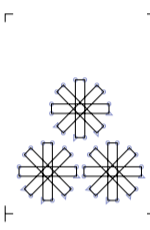

asterism 2042

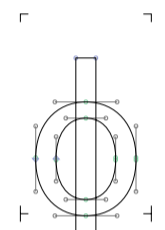

philatin 0278



sixroman 2175



cyrillichookleft

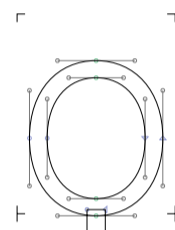

uni03D8 03D8

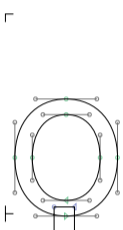

uni03D9 03D9

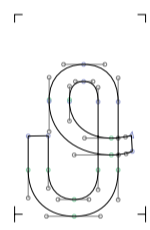

thetasymbolgreek 03D1

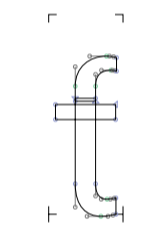

thook 01AD

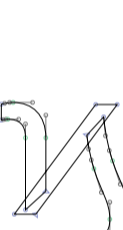

uni03D7 03D7

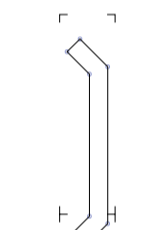

uni27EF 27EF

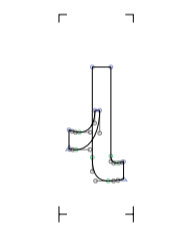

finaltsadi 02B5

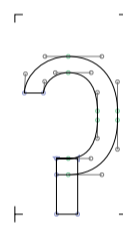

glottalstop 0294



uni0359 0359

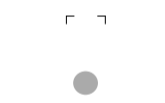

uni0358 0358



uni0355 0355



uni0354 0354



uni0357 0357



uni0356 0356

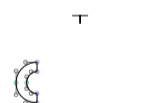

uni0351 0351

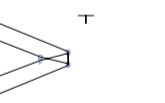

uni0350 0350



uni0353 0353

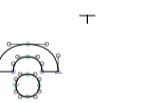

uni0352 0352

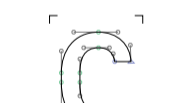

glottalstopreversedmod 02C1

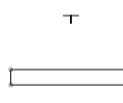

uni035E 035E

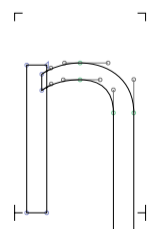

uni0220 0220

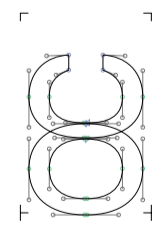

uni0223 0223



uni035F 035F



uni035C 035C

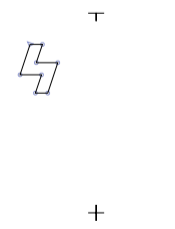

uni035B 035B

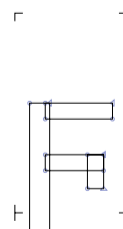

digamma 03DD

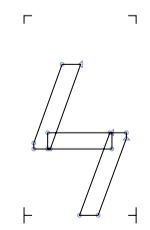

koppa 03DF

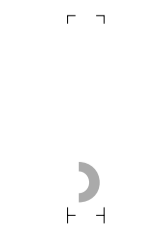

ringhalfrightcentered 02D2

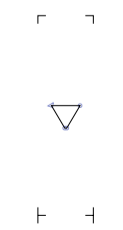

colontriangularhalfmod 02D1

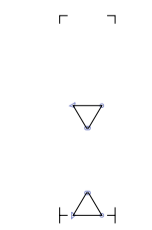



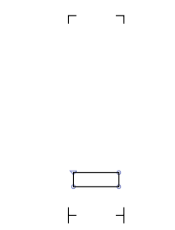



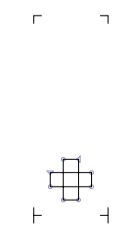



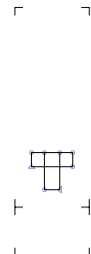

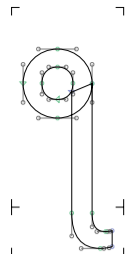

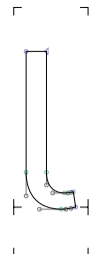

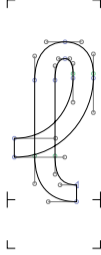



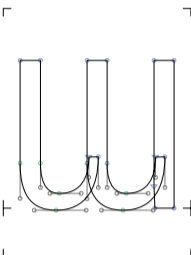

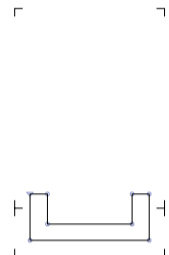











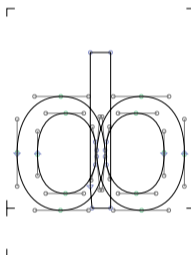
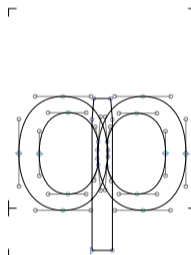

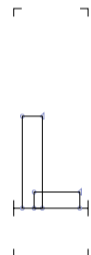
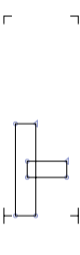

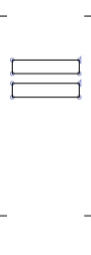

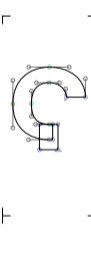

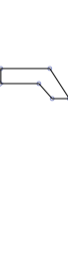
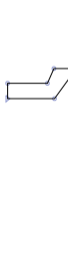
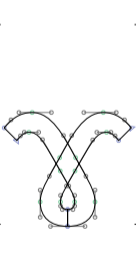
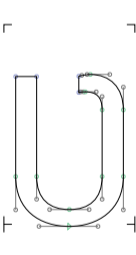
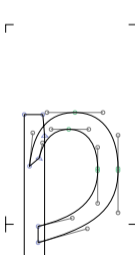
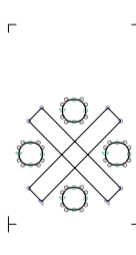
colontriangularmod 02D0

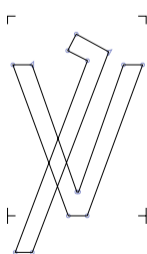

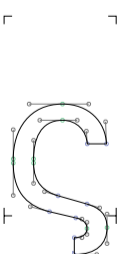
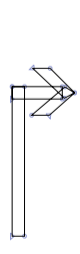



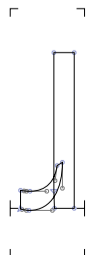



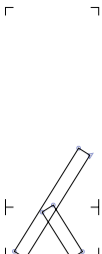
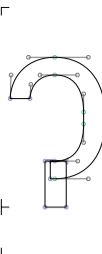







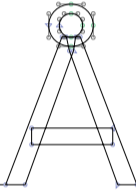

minusmod 02D7

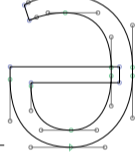
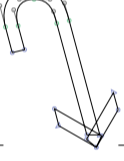
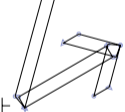
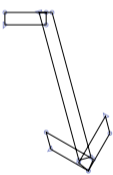
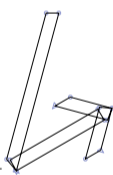
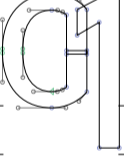
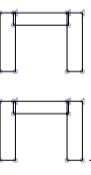

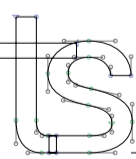
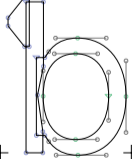
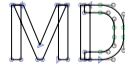

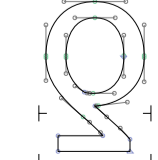
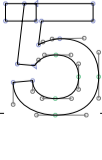

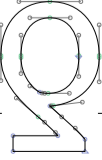
plusmod 02D6

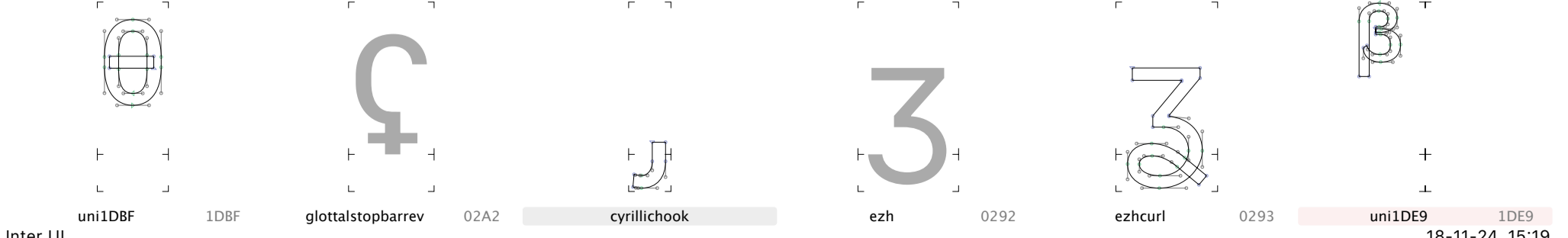
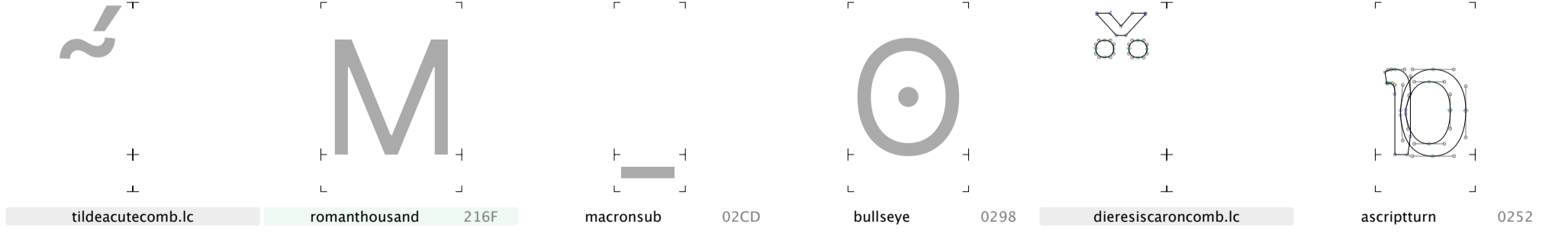
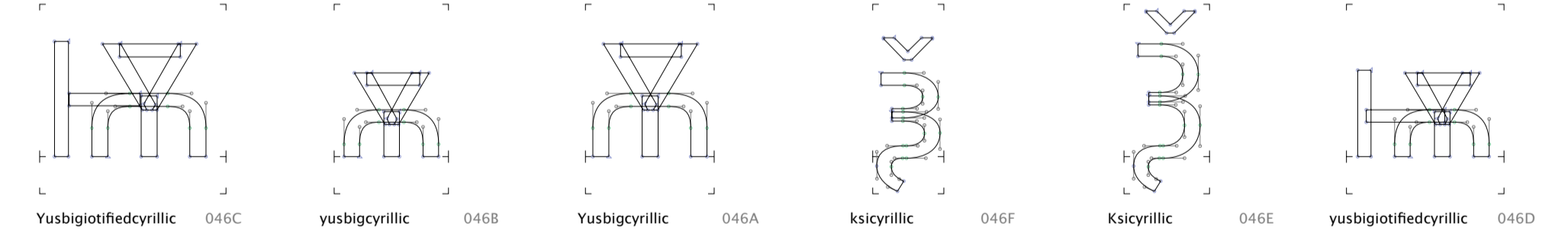
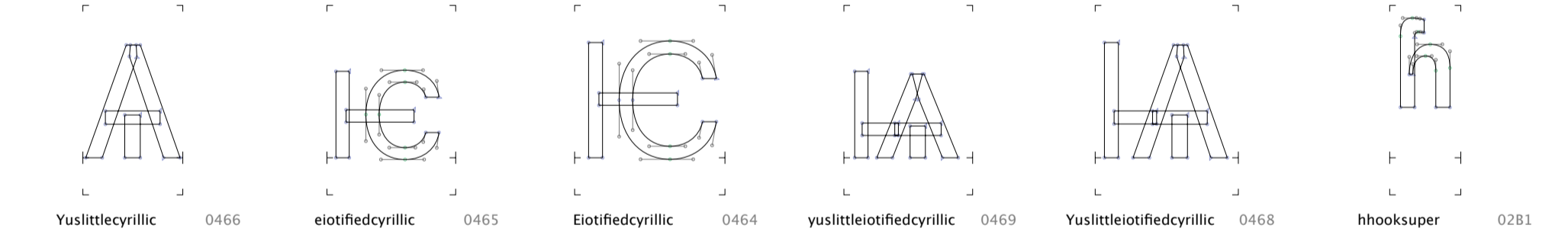
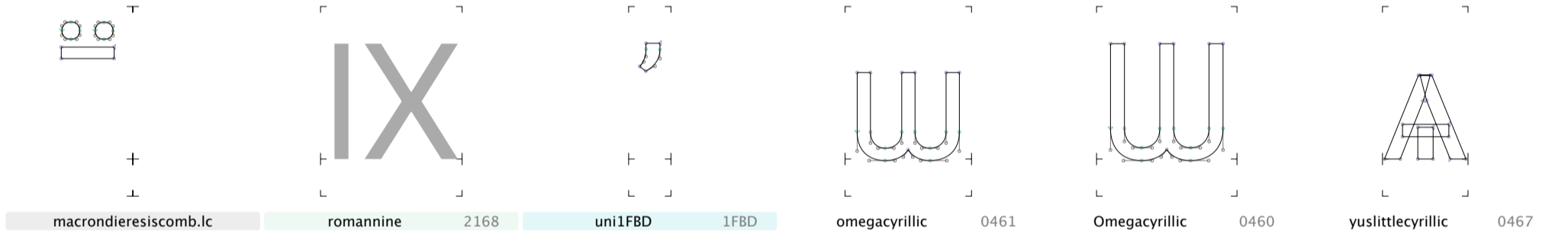
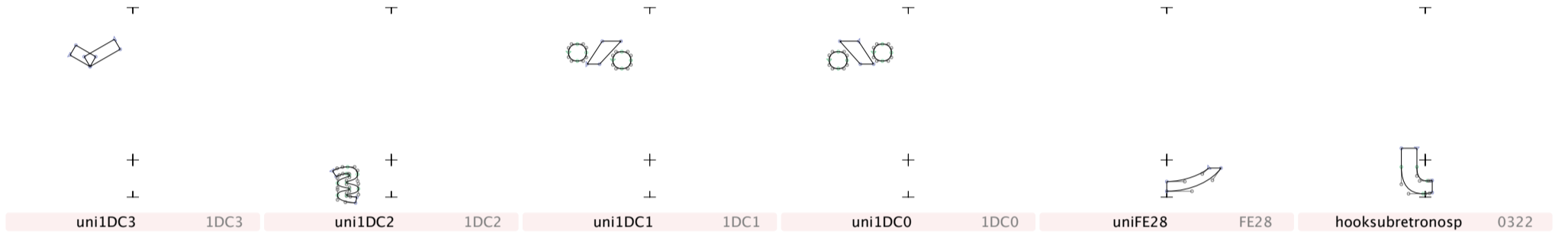
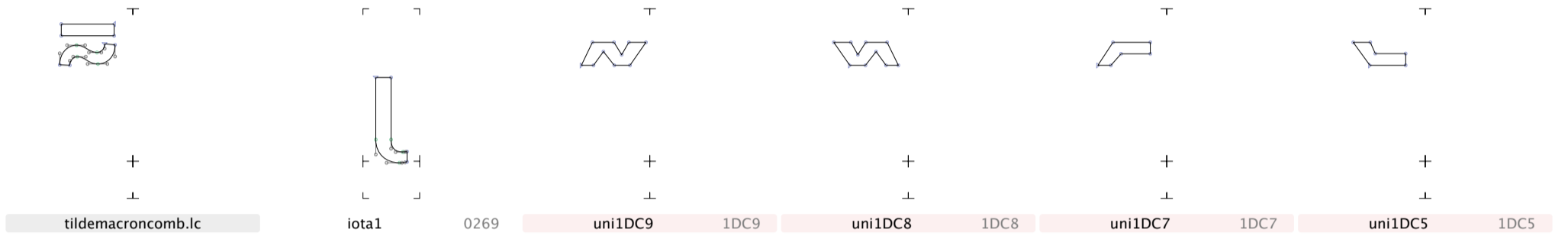
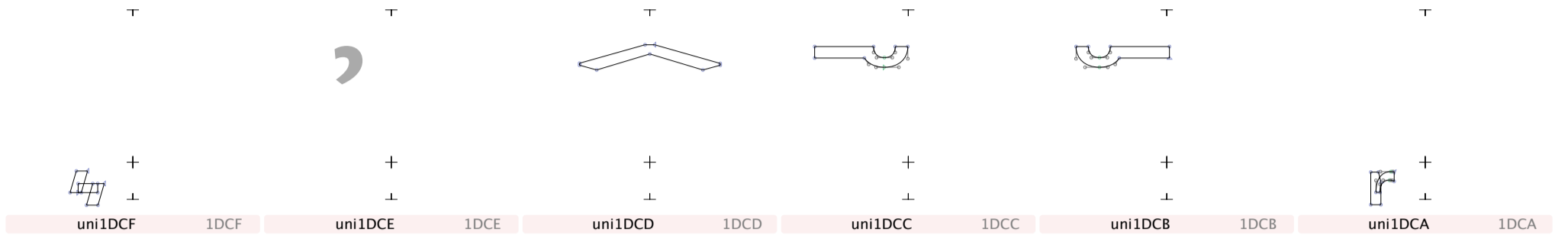
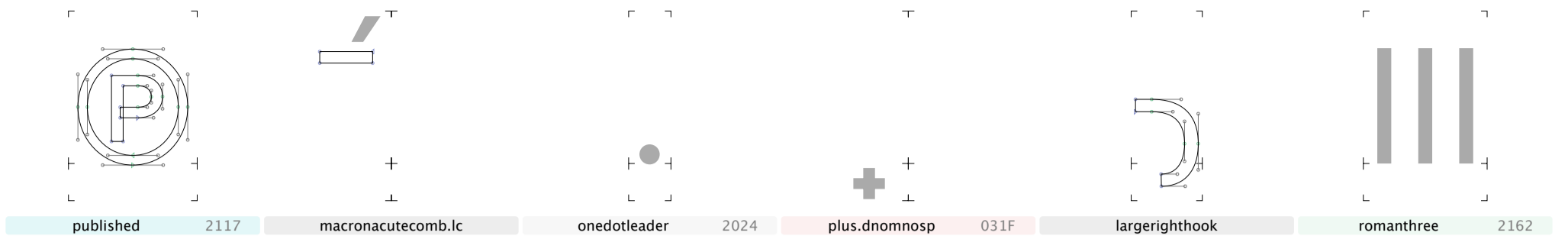
					
downtackmod 02D5	linevertnosp 030D	eshlooprev 01AA	verticalbardbl 2016	romaneleven 216A	lota1 0196
					
uniA69F A69F	lsquare 2113	rhotichookmod 02DE	uni1DD6 1DD6	uni1DD7 1DD7	linevertsubnosp 0329
					
mcapture 019C	uni205D 205D	spaceopenbox 2423	uni034B 034B	uni034C 034C	uni034A 034A
					
uni034F 034F	uni034D 034D	uni034E 034E	uni0348 0348	uni0349 0349	perispomenigreekcmb 0342
					
koroniscmb 0343	uni0347 0347	uni0238 0238	uni0239 0239	tackdownsubnosp 031E	uni02EA 02EA
					
uni02EB 02EB	uni2071.ccmp	uni02ED 02ED	uni02EF 02EF	glottalstopreversed.numr 02E4	afii61664 200C
					
uni1DC6 1DC6	uni1DC4 1DC4	babygamma 0264	Vcursive 0182	wynn 018F	referencemark 203B
					
overscorenosp 0305	versicle 2123	hyphen_ 2010	diaeresistonosp 0344	stigma 03DB	afii57596 200E
					
afii57598 200D	uni2B4E 2B4E	uni2B4F 2B4F	rturnascend 027A	romanfivehundred 216E	caret 2038

					
caretinsertionpoint 2041	bridgesubnosp 032A	uni0242 0242	uni0241 0241	uni0245 0245	uni02F9 02F9
					
uni02F8 02F8	uni02F5 02F5	uni02F4 02F4	uni02F7 02F7	uni02F6 02F6	uni02F1 02F1
					
uni02F0 02F0	uni02F3 02F3	uni02F2 02F2	dotmacroncomb.lc	uni02FE 02FE	uni02FD 02FD
					
uni02FF 02FF	uni02FA 02FA	uni02FC 02FC	uni02FB 02FB	angstrom 212B	macrongravecomb.lc
					
macronsubnosp 0331	ringlefthalfsubnosp 031C	Lsmallcap 029F	squaresubnosp 033B	Schwa 018F	uni2B5B 2B5B
					
uni2B5C 2B5C	uni2B5A 2B5A	uni2B5F 2B5F	uni2B5D 2B5D	uni2B5E 2B5E	oi 01A3
					
finalmem 02AD	Gsmallcap 0262	Esh 01A9	dieresismacroncomb.lc	Rsmallcapinv 0281	zerowidthjoiner FEFF
					
ts 02A6	tonesix 0185	uni1F16B 1F16B	pisymbolgreek 03D6	uni1F16A 1F16A	dieresisgravecomb.lc
					
tonefive 01BD	tel 2121	commasuprevnosp 0314	hyphennobreak 2011	archdblsubnosp 032B	deltaturn 018D

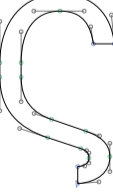

					
numeralgreek 0374	Omegaroundcyrillic 047A	omegaroundcyrillic 047B	Omegatitlocyrllic 047C	omegatitlocyrllic 047D	Otcyrllic 047E
					
otcyrllic 047F	gcursive 0261	uni035D 035D	uni035A 035A	quotedbversed 201F	Rturnsuper 0286
					
uni1FCE 1FCE	uni1FCF 1FCF	upsilonlatin 028A	uni1FC1 1FC1	uni1FC0 1FC0	ringhalfleftcentered 02D3
					
omegaclosed 0277	uni1DE2 1DE2	OI 01A2	xsupnosp 033D	sampi 03E1	eshshortrev 0285
					
ounce 2125	vscript 0288	acuterightnosp 0341	barmidlongnosp 0336	tildevertsupnosp 033E	linevertdblnosp 030E
					
jhooqdblbar 0284	overline 203E	ascript 0251	uni03CF 03CF	uni20DC 20DC	uni20DB 20DB
					
romansix 2165	uni1FBF 1FBF	uni1FBE 1FBE	ypogegrameni 037A	romaneight 2167	charactertie 2040
					
Stigma 03DA	Epsilon1 0190	iotasubnosp 0345	pipedblbar 01C2	YR 01A6	kgreenlandic 0138
					
uni2182 2182	uni2180 2180	uni2181 2181	uni2186 2186	uni2187 2187	uni2184 2184

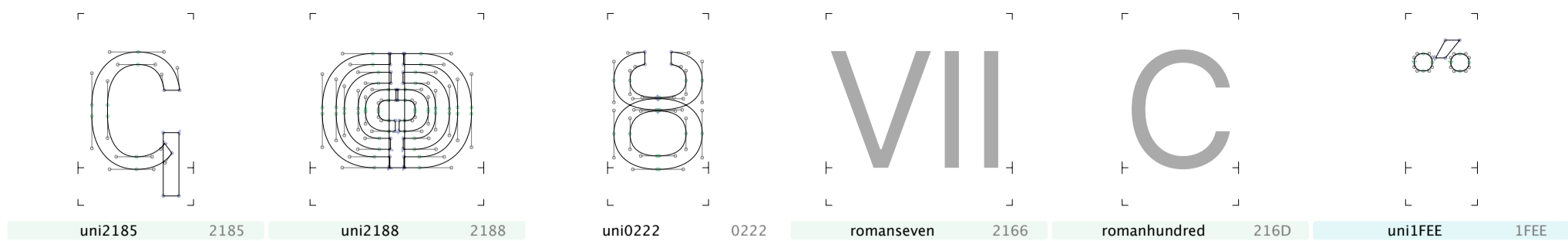

uni2185 2185 uni2188 2188 uni0222 0222 romanseven 2166 romanhundred 216D uni1FEE 1FEE

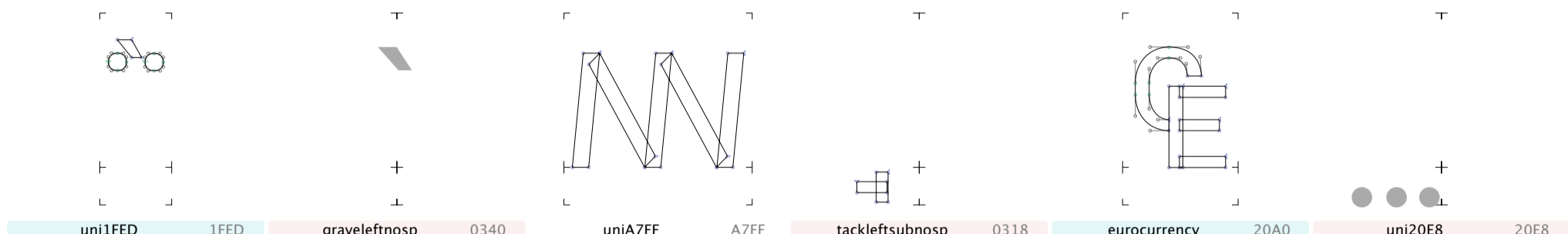

uni1FED 1FED graveleftnosp 0340 uniA7FF A7FF tackleftsubnosp 0318 eurocurrency 20A0 uni20E8 20E8

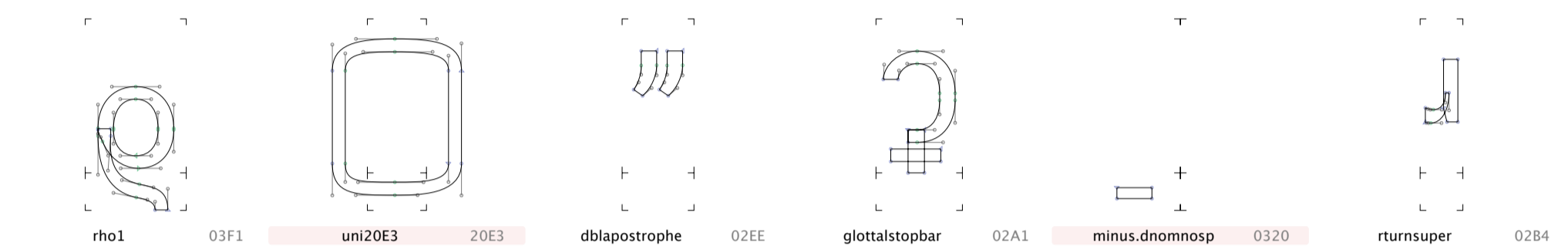

rho1 03F1 uni20E3 20E3 dblapostrophe 02EE glottalstopbar 02A1 minus.dnomnosp 0320 rturnsuper 02B4

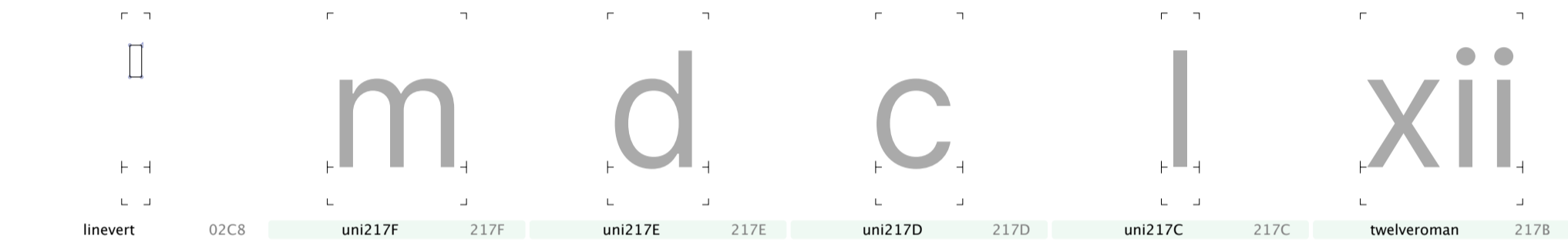

linevert 02C8 uni217F 217F uni217E 217E uni217D 217D uni217C 217C twelveroman 217B

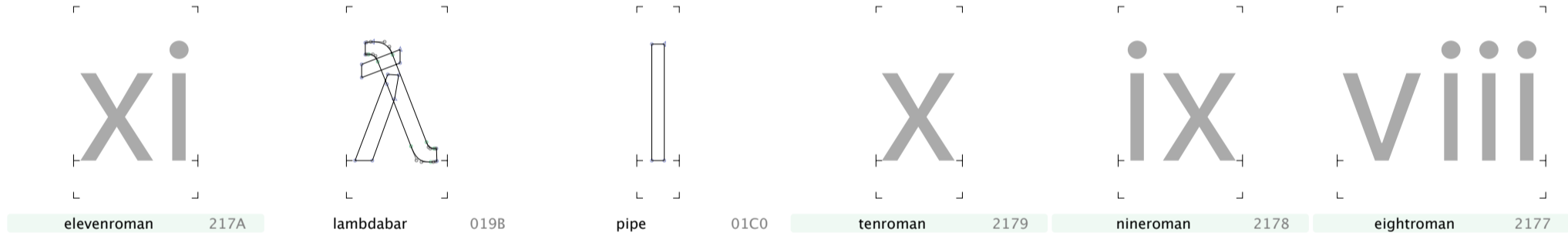

elevenroman 217A lambdabar 0198 pipe 01C0 tenroman 2179 nineroman 2178 eightroman 2177

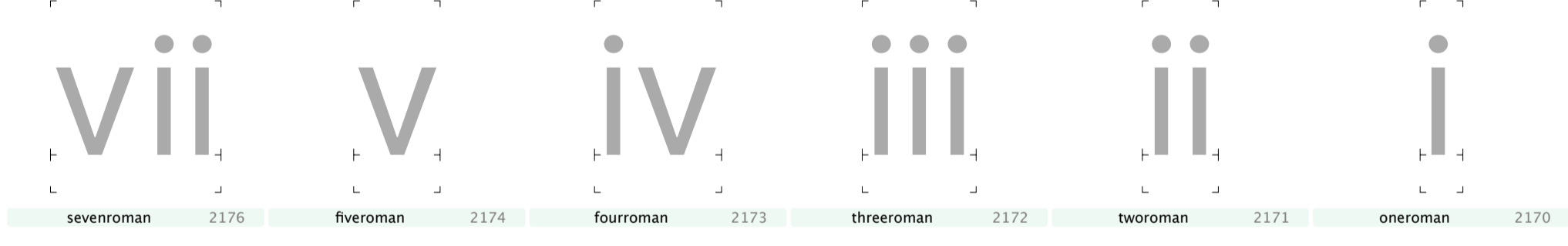

sevenroman 2176 fiveroman 2174 fourroman 2173 threeroman 2172 tworoman 2171 oneroman 2170

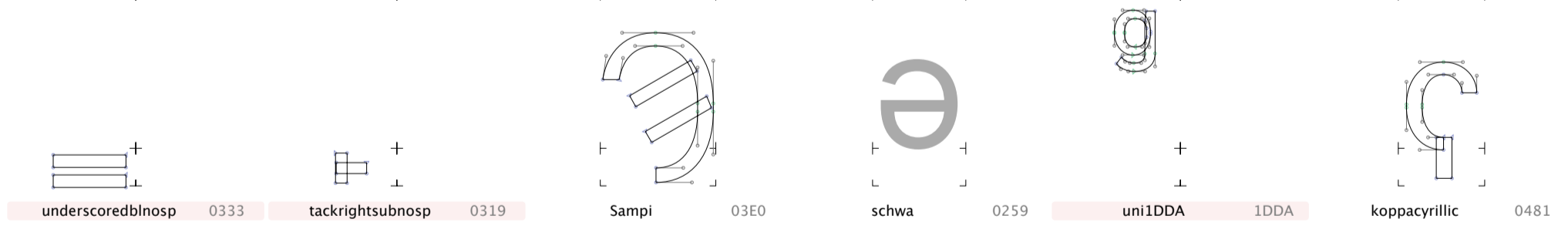



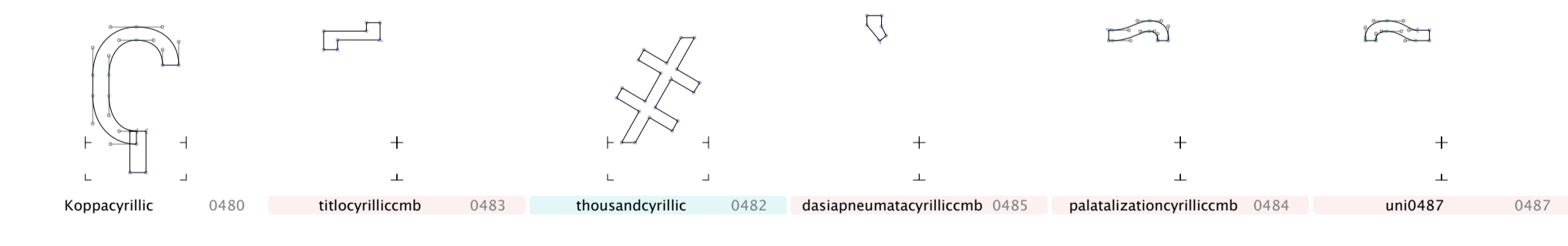







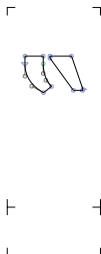

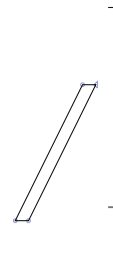
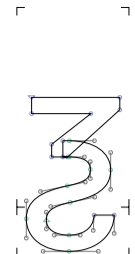







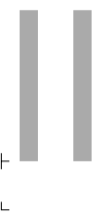
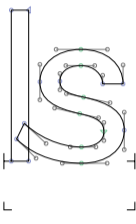
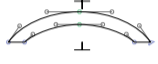
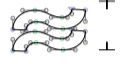

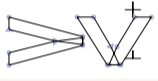



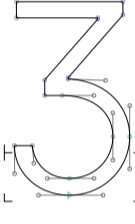

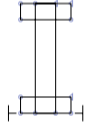

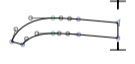



underscoredblno 0333 tackrightsubnosp 0319 Sampi 03E0 schwa 0259 uni1DDA 1DDA koppacyrillic 0481

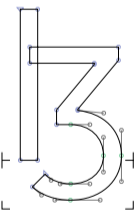

Koppacyrillic 0480 titlocyrlilicmb 0483 thousandcyrillic 0482 dasiapneumatacyrilliccmb 0485 palatalizationcyrilliccmb 0484 uni0487 0487

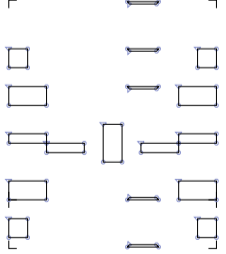
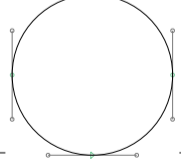
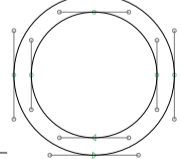
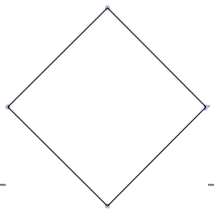
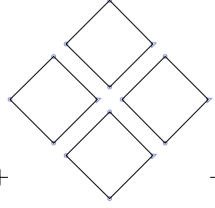
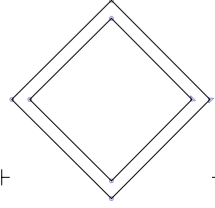
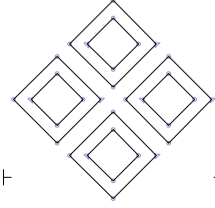
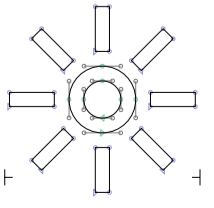
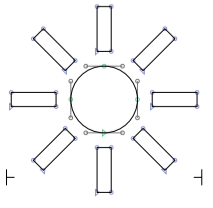
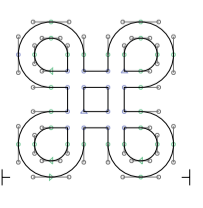

psilipneumatacyrilliccmb 0486 uni0489 0489 uni0488 0488 uni20F0 20F0 eshcurl 0286 quotereversed 201B

					
romanfive 2164	uni1FDD 1FDD	uni1FDE 1FDE	uni1FDF 1FDF	slashshortnosp 0337	ezhtail 01BA
					
uni1DF0 1DF0	uni1DF1 1DF1	uni1DF2 1DF2	uni1DF3 1DF3	uni1DF4 1DF4	uni1DF5 1DF5
					
caronbelowcmb 032C	acutesubnosp 0317	romantwo 2161	finalkaf 02AA	uni1DFC 1DFC	uni1DFD 1DFD
					
uni1DFE 1DFE	uni1DFE 1DFE	uni1FEF 1FEF	Ezhreversed 0188	ezhreversed 0189	Ezh 01B7
					
romanfifty 216C	ringhalfright 02BE	lsmallcap 026A	uptackmod 02D4	hyphendot 2027	uniFE29 FE29
					
uniFE20 FE20	uniFE21 FE21	uniFE22 FE22	uniFE23 FE23	uniFE24 FE24	uniFE25 FE25
					
uniFE26 FE26	uniFE27 FE27	lyogh 026E	uniFE2A FE2A	uniFE2B FE2B	uniFE2C FE2C
					
uniFE2D FE2D	gammassuper 02E0	uniE001 E001	circleblack 25CF	circlewhite 25CB	diamondblack 25C6
					
diamondblack_x 2756	diamondwhite 25C7	diamondwhite_x E000	sunWithRays 263C	blackSunWithRays 2600	placeofinterestsign 2318

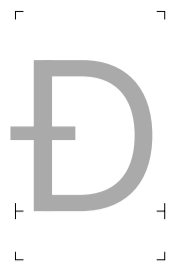

Eth 00D0



Dcroat 0110



IJ 0132



Ldot 013F

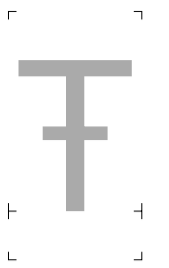

Tbar 0166



LJ 01C7



NJ 01CA



DZ 01F1



Aogonek.NAV

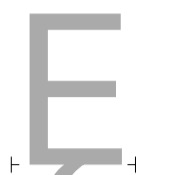

Eogonek.NAV

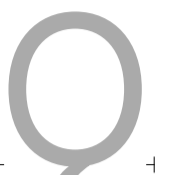

Oogonek.NAV



uni03F7 03F7



afi10020 0413



afi10052 0403



afi10033 041F



afi10034 0420



afi10035 0421



afi10036 0422



afi10039 0425



afi10146 0462



Psycyrillic 0470



Ukcyrillic 0478



uni048C 048C



Ghestrokecyrillic 0492



Zedescendercyrillic 0498



Esdescendercyrillic 04AA



Tescendercyrillic 04AC



Ustraightcyrillic 04AE



Ustraightstrokecyrillic 04B0

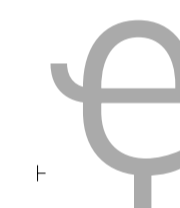

Chedescenderabkhasiacyrillic 04BE



palochkacyrillic 04C0



Chekhakassiacyrillic 04CB

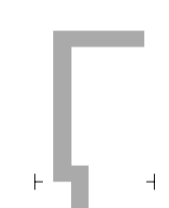

uni04F6 04F6

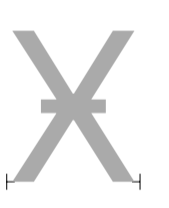

uni04FE 04FE

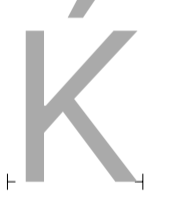

afi10061 040C



Schwadiesiscyrillic 04DA



Zhebrevecyrillic 04C1



Zhedieresiscyrillic 04DC



Zedieresiscyrillic 04DE



afi10062 040E



Umacroncyrillic 04EE



Udieresiscyrillic 04F0



Uhungarumlautcyrillic 04F2



Chedieresiscyrillic 04F4



Yerudieresiscyrillic 04F8



uni04EC 04EC



Izhitsadblgravecyrillic 0476



uni0299 0299



uni029C 029C



aogonek.NAV



eogonek.NAV

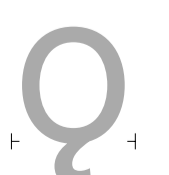

oogonek.NAV

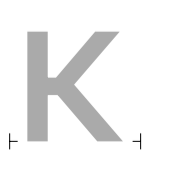

kappa 03BA



mugreek 03BC

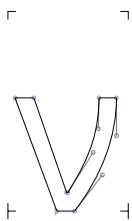

nu 03BD



uni03F8 03F8



uni1F71 1F71



uni1F73 1F73



uni1F75 1F75



uni1F77 1F77



uni1F79 1F79

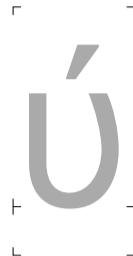

uni1F7B 1F7B



uni1F7D 1F7D



uni1FD3 1FD3



uni1FE3 1FE3



psicrillic 0471



ghestrokecyrillic 0493



zedescendercyrillic 0499



esdescendercyrillic 04AB



tedescendercyrillic 04AD



ustraightcyrillic 04AF



ustraightstrokecyrillic 04B1



chedescenderabkhasiancyrillic 04BF



chekhakassiancyrillic 04CC



schwacyrillic 04D9



schwadiesiscyrillic 04DB



obarredcyrillic 04E9



obarreddiesiscyrillic 04EB



uni04F7 04F7



uni04FF 04FF



chedieresiscyrillic 04F5



uni04ED 04ED



gjecyrillic 0453



iishortcyrillic 0439



uni045D 045D



imacroncyrillic 04E3



idieresiscyrillic 04E5



izhitsadblgravecyrillic 0477



kjecyrillic 045C



yerudieresiscyrillic 04F9



zedieresiscyrillic 04DF



zhebrevcyrillic 04C2



zhedieresiscyrillic 04DD



Ezhcaron 01EE

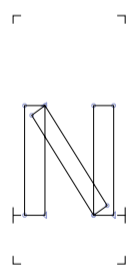

Nsmallcap 0274

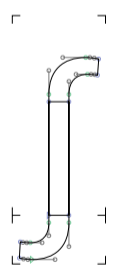

esh 0283



ezhcaron 01EF

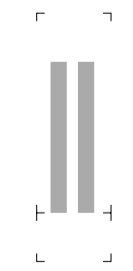

pipedbl 01C1

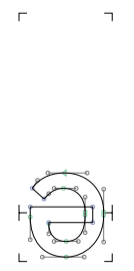

uni2094 2094

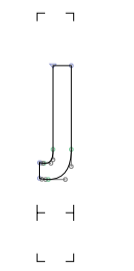

uni02B2.ccmp



Eltail-cy 04C5

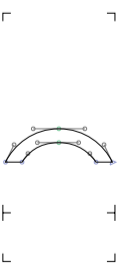

uniA92E A92E

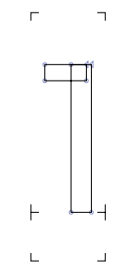

tonebarextrahighmod.cn 02E5

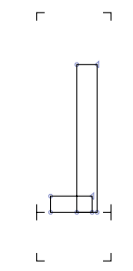

tonebarextralowmod.cn 02E9

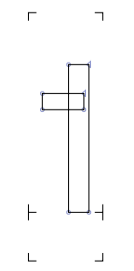

tonebarhighmod.cn 02E6

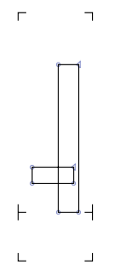

tonebarlowmod.cn 02E8

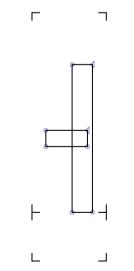

tonebarmidmod.cn 02E7



commaabovecmb 0313

+	+	+	+	+	+
+	+	+	+	+	+
commaaboverightcmb 0315	hooksubpalatnosp 0321	bridgeinvsubnosp 033A	uni1DE7 1DE7	uni1DE8 1DE8	uni1DEA 1DEA

+	+	+	+	+	+
+	+	+	+	+	+
uni1DEB 1DEB	uni1DEC 1DEC	uni1DED 1DED	uni1DEE 1DEE	uni1DEF 1DEF	macronacutecomb.cn

+	+	+	+	+	+
+	+	+	+	+	+
macrongravecomb.cn	uni1FFE.tonos	uni1FCD.tonos	uni1FDD.tonos	uni1FCE.tonos	uni1FDE.tonos

+	+	+	+	+	+
+	+	+	+	+	+
uni1FCF.tonos	uni1FDF.tonos	uni1FEF.tonos	uni1FFD.tonos	uni1DE0 1DE0	uni1DE1 1DE1

+	+	+	+	+	+
+	+	+	+	+	+
uni1DE3 1DE3	uni1DE4 1DE4	uni1DE5 1DE5	uni1DE6 1DE6	cyrillictic.cn	controlHT

+	+	+	+	+	+
+	+	+	+	+	+
controlSOT	commaaccentright.cn	ringacute.cn	circumflexgravecomb.cn	dieresisacaroncomb.cn	dieresismacroncomb.cn

+	+	+	+	+	+
+	+	+	+	+	+
carondotcomb.cn	breveacutecomb.cn	acutedotcomb.cn	brevegravecomb.cn	circumflexacutecomb.cn	tildedieresiscomb.cn

+	+	+	+	+	+
+	+	+	+	+	+
circumflexhookcomb.cn	brevetildecomb.cn	dieresisacutecomb.cn	dotmacroncomb.cn	macrondieresiscomb.cn	dieresisgravecomb.cn

+	+	+	+	+	+
+	+	+	+	+	+
tildemacroncomb.cn	circumflextildecomb.cn	brevehookcomb.cn	commaaccentrotate.cn	tildeacutecomb.cn	tonostop

⌈ ⌋

⌈ ⌋



⌈ ⌋

⌈ ⌋

cyrillictail.cn

koronisaccentleft.cn