

Mi·Light[®]

LEADER OF SMART LIGHTING



PRODUCT
CATALOGUE
2017

Futlight Optoelectronics Co.,Ltd

Add: Floor 2, Buiding D, Fusen Technology Park, Hangcheng Road, Bao'an District, Shenzhen City, Guangdong Province, China
Tel: (+86) 755-61176580 61176581 Fax: (+86) 755-61176582 E-mail: sales@futlight.com
<http://www.futlight.com> www.futlight.cn

Futlight Optoelectronics Co.,Ltd
www.futlight.com

ABOUT US

Shenzhen Futlight Optoelectronics Co., Limited is a high-tech enterprise, located in Shenzhen China, who specializes in R&D, manufacturing and selling all kinds of smart led lighting, our main products include smart led light bulbs, led down lights, LED track lights and led controllers.

We are proud of our smart ideas and concepts of making led lights more intelligent and convenient, all the products can be operated by wireless remote control, and more comprehensively by smart phone App! The well trained production line and QC staff can assure all the products with high quality. We sell our products widely in Europe, North America, South America, Australia, Middle East, and Asia . All the products are CE&Rohs certified. Due to the top quality , reasonable price and good after-sale service, we have also won the trust and support from our customers and obtained a good reputation both domestically and abroad.

Shenzhen Futlight has been one of leading manufacturers in the smart LED field and we will always be . With all staff's efforts, we will focus on new ideas and keep developing more new products. The revolution of led lighting has come, we are the leader of the smart led lighting!

contents

■ 2.4GHz Series

LED Outdoor Light Serise	01-04
LED Spotlight Series	05-06
LED Downlight Series	07-08
LED Light Bulb Series	09-10
LED Strip Controller Series	11-14
LED Strip Light Control System	15-16
LED Rail Tracklight	17-18
Smart Panel Controller Series	19-20
Smart Panel Remote Controller Series	21-24
Remote Controller Series	25-26

■ WiFi Series

iBox1 WiFi Smart Light	27
iBox2 WiFi Conrtoller	28

■ 0/1~10V Series

0/1~10V Dimming Driver	29-30
------------------------------	-------

■ DMX512 Series

DMX 512 LED Transmitter	31
DMX512 RGB+CCT Strip Controller	32
DMX512 RGB+CCT LED Light Bulb	32

SMART LED Garden Light

2.4GHz RF remote controllable
Smart phone APP long distance control
(Mi-Light WiFi iBox is needed)

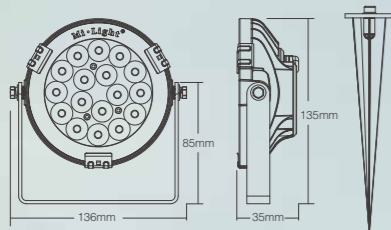

Compatible Remote:











700LM

9W Low Power Consumption

2.4G
Radio Frequency

Features

-  RGB+CCT
16 Millions of colors to choose
-  Color temperature
2700~6500K
-  Dimmable
Saturation control
-  2.4G RF wireless transmission technology
-  Remote control
Control distance 30m
-  Smart phone App control
Mi-Light WiFi iBox is needed
-  Waterproof and dustproof
grade IP65
-  Beam Angle 15°
Illumination distance Greater than 10m



Auto-transmitting Diagram

One Garden Light can transmit the signals from the remote control to another Garden Light within 30m, as long as there is a Garden Light within 30m, the remote control distance can be limitless.

Auto-synchronization function

Different Garden Light can work synchronously when they are started at different times, controlled by the same remote, under same dynamic mode and with same speed.

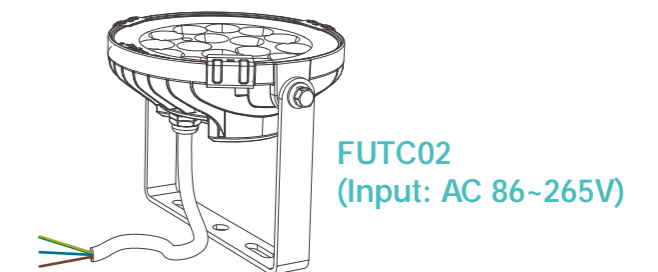
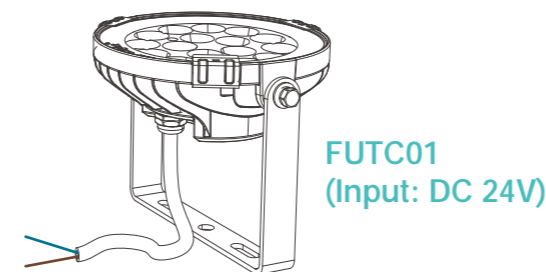
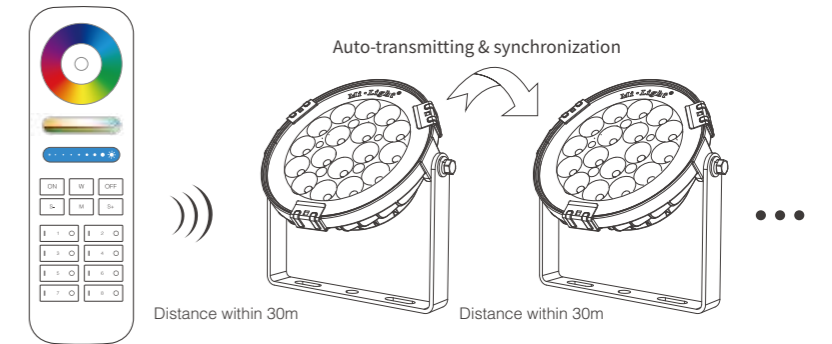

Model No.	Input Voltage	Power	Kelvin	Luminous Flux	Light Efficiency	CRI	PF	Beam angle	Illumination distance	IP Rate
FUTC01	DC 24V	9W	2700~6500K	700LM	80LM/W	>80	—	15°	>10m	IP65
FUTC02	AC86-265V 50-60Hz						0.5			

SMART LED Floodlight

2.4GHz RF remote controllable
Smart phone APP long distance control
(Mi-Light WiFi iBox is needed)

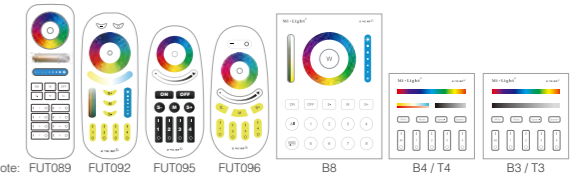

RGB+CCT LED Floodlight Series

Model No.	Power	Input Voltage	Kelvin	Luminous Flux	Light Efficiency	CRI	Beam Aluminum	PF	IP Rate
FUTT02	50W	AC86~265V 50~60Hz	2700~6500K	3500~4200LM	85LM/W	>80	160°	>0.9	IP65
FUTT03	30W			2500~2800LM				>0.9	
FUTT04	20W			1500~1800LM				>0.9	
FUTT05	10W			750~900LM				>0.5	
FUTT06	10W	DC 24V	750~900LM	>0.5					

Features

2.4GHz RF remote controllable, WiFi enabled smart phone control. 16 Millions of colors to choose, color temperature, brightness & saturation controllable.

- RGB+CCT
16 Millions of colors to choose
- Color temperature
2700~6500K
- Dimmable
Saturation control
- 2.4G RF wireless transmission technology
- Remote control
Control distance 30m
- Smart phone App control
Mi-Light WiFi iBox is needed

Automatic Commands Transmitting Function

One floodlight can send the commands from the remote control to another, which makes the control distance limitless. (The distance from one light to another has to be within 30m)

Auto-synchronization function

Different floodlight can work synchronously when they are started at different times, controlled by the same remote, under same dynamic mode and with same speed.

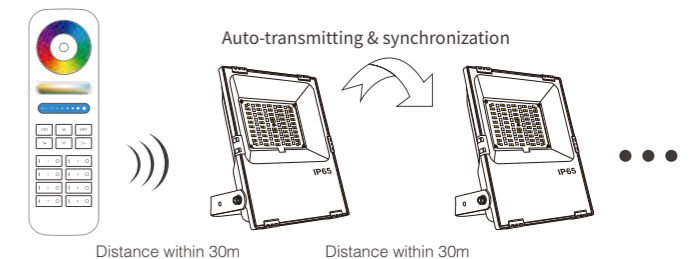

SMART LED Spotlight

2.4GHz RF remote controllable
Smart phone APP long distance control
(Mi-Light WiFi iBox is needed)

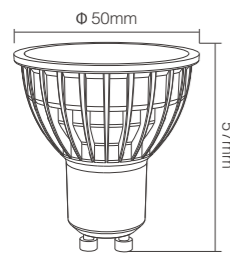

FUT103 GU10 RGB+CCT LED Spotlight

Model No.	Power	Input Voltage	Kelvin	Luminous Flux	Light Efficiency	CRI	PF	Beam angle
FUT103	4W	AC86~265V 50~60Hz	2700~6500K	250~280LM	70LM/W	>80	0.55	25°

Compatible Remote: FUT089 B8 FUT092 FUT095 FUT096 B4 / T4



Features

2.4GHz RF remote controllable, WiFi enabled smart phone control. 16 Millions of colors to choose, color temperature, brightness & saturation controllable.

RGB+CCT
16 Millions of colors to choose

Color temperature
2700~6500K

Dimmable
Saturation control

2.4G RF wireless transmission
technology

Remote control
Control distance 30m

Smart phone App control
Mi-Light WiFi iBox is needed

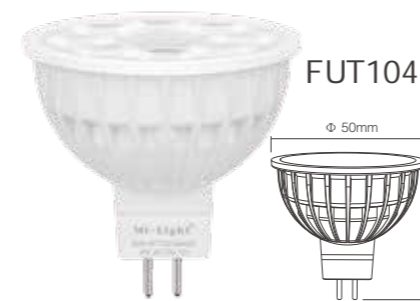

MR16 RGB+CCT LED Spotlight

- 2.4GHz RF remote controllable, control distance within 30 meters
- Dimmable & color temperature adjustable color changing & saturation control
- Smart phone APP control, long distance control (Mi-Light WiFi iBox is needed)

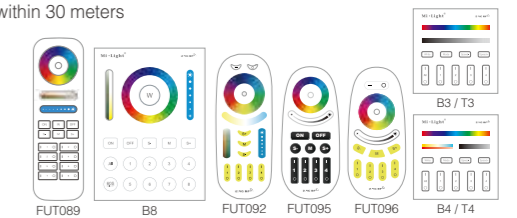

Model No.	Power	Input Voltage	Kelvin	Luminous Flux	Light Efficiency	CRI	Beam angle
FUT104	4W	AC/DC 12V	2700~6500K	250~280LM	70LM/W	>80	25°



GU10 RGBW LED Spotlight

- 2.4GHz RF remote controllable, control distance within 30 meters
- RGB+W Color changing & Brightness Dimmable
- Smart phone APP control, long distance control (Mi-Light WiFi iBox is needed)

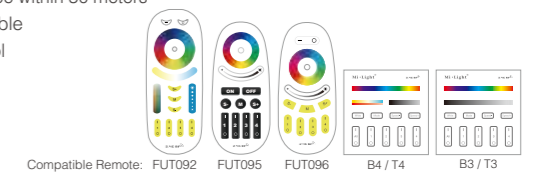

Model No.	Power	Input Voltage	Kelvin	Luminous Flux	Light Efficiency	CRI	Beam angle
FUT018	5W	AC86~265V 50~60Hz	WW(2700~3200K) CW(6000~6500K)	440~490LM	85~90LM/W	>80	30°









FUT062 9W RGB+CCT LED Ceiling Spotlight

Model No.	Input Voltage	Kelvin	Luminous Flux	Light Efficiency	CRI	PF	Beam angle	Hole Size
FUT062	AC86~265V 50~60Hz	2700~6500K	700LM	80LM/W	>80	>0.5	15°	ø120~125mm









Features

2.4GHz RF remote controllable, WiFi enabled smart phone control. 16 Millions of colors to choose, color temperature, brightness & saturation controllable.

-  RGB+CCT
16 Millions of colors to choose
-  Color temperature
2700~6500K
-  Dimmable
Saturation control
-  2.4G RF wireless transmission
technology
-  Remote control
Control distance 30m
-  Smart phone App control
Mi-Light WiFi ibox is needed

RGB+CCT LED Downlight Series

2.4GHz RF remote controllable, WiFi enabled smart phone control. 16 Millions of colors to choose, color temperature, brightness & saturation controllable.

-  RGB+CCT 16 Millions
of colors to choose
-  Color temperature
2700~6500K
-  Dimmable
Saturation control
-  2.4G RF wireless
transmission technology
-  Remote control
Control distance 30m
-  Smart phone App control
Mi-Light WiFi ibox is needed

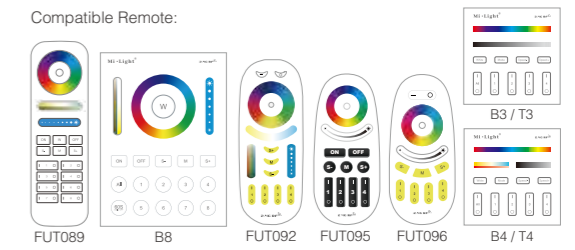

FUT066 12W RGB+CCT LED Downlight

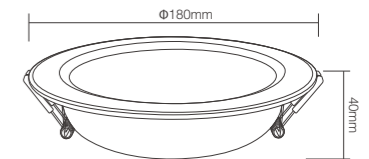

Model No.	Input Voltage	Kelvin	Luminous Flux	Light Efficiency	CRI	PF	Beam angle	Hole Size
FUT066	AC86~265V 50~60Hz	2700~6500K	1100LM	88LM/W	>80	>0.5	120°	ø145~150mm



FUT067 15W RGB+CCT LED Downlight

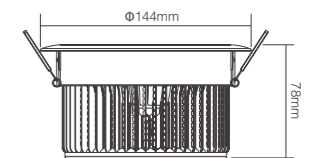

Model No.	Input Voltage	Kelvin	Luminous Flux	Light Efficiency	CRI	PF	Beam angle	Hole Size
FUT067	AC86~265V 50~60Hz	2700~6500K	1300LM	88LM/W	>80	>0.5	120°	ø130~140mm



FUT068 6W RGB+CCT LED Downlight

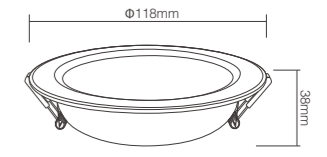

Model No.	Input Voltage	Kelvin	Luminous Flux	Light Efficiency	CRI	PF	Beam angle	Hole Size
FUT068	AC86~265V 50~60Hz	2700~6500K	600LM	85LM/W	>80	>0.5	120°	ø90~95mm



FUT069 IP54 Waterproof 15W RGB+CCT LED Downlight

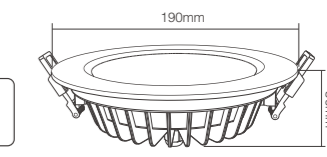

Model No.	Input Voltage	Kelvin	Luminous Flux	Light Efficiency	CRI	PF	Beam angle	Hole Size
FUT069	AC86~265V 50~60Hz	2700~6500K	1200LM	80LM/W	>80	>0.5	120°	ø175~180mm



SMART LED Light Bulb

2.4GHz RF remote controllable
Smart phone APP long distance control
(Mi-Light WiFi iBox is needed)

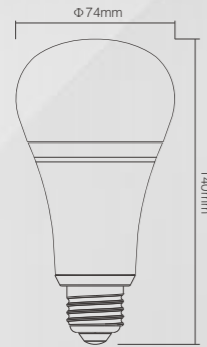

E14 5W RGB+CCT LED Light Bulb

- 2.4GHz RF remote controllable, control distance within 30 meters
- Dimmable & color temperature adjustable color changing & saturation control
- Smart phone APP control, long distance control (Mi-Light WiFi iBox is needed)



Model No.	Input Voltage	Kelvin	Luminous Flux	Light Efficiency	CRI	PF	Beam angle	Base Type
FUT013	AC86~265V 50~60Hz	2700~6500K	450LM	90LM/W	>80	>0.5	240°	E14



6W RGB+CCT LED Light Bulb

- 2.4GHz RF remote controllable, control distance within 30 meters
- Dimmable & color temperature adjustable color changing & saturation control
- Smart phone APP control, long distance control (Mi-Light WiFi iBox is needed)



Model No.	Input Voltage	Kelvin	Luminous Flux	Light Efficiency	CRI	PF	Beam angle	Base Type
FUT014	AC86~265V 50~60Hz	2700~6500K	550LM	95LM/W	>80	>0.5	180°	E26 / E27 / B22

FUT105 12W RGB+CCT LED Light Bulb

Model No.	Input Voltage	Kelvin	Luminous Flux	Light Efficiency	CRI	PF	Beam angle	Base Type
FUT105	AC86~265V 50~60Hz	2700~6500K	1100LM	90LM/W	>80	>0.5	220°	E26 / E27 / B22

Compatible Remote: FUT089 B8 FUT092 FUT095 FUT096 B3/T3 B4/T4

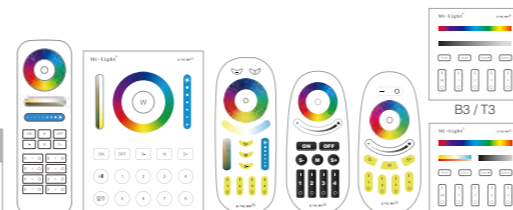

Features

2.4GHz RF remote controllable, WiFi enabled smart phone control. 16 Millions of colors to choose, color temperature, brightness & saturation controllable.

- RGB+CCT 16 Millions of colors to choose
- Color temperature 2700~6500K
- Dimmable Saturation control
- 2.4G RF wireless transmission technology
- Remote control Control distance 30m
- Smart phone App control Mi-Light WiFi iBox is needed



9W RGB+CCT LED Light Bulb

- 2.4GHz RF remote controllable, control distance within 30 meters
- Dimmable & color temperature adjustable color changing & saturation control
- Smart phone APP control, long distance control (Mi-Light WiFi iBox is needed)



Model No.	Input Voltage	Kelvin	Luminous Flux	Light Efficiency	CRI	PF	Beam angle	Base Type
FUT012	AC86~265V 50~60Hz	2700~6500K	850LM	95LM/W	>80	>0.5	220°	E26 / E27 / B22

SMART LED Strip Controller

2.4GHz RF remote controllable
Smart phone APP long distance control
(Mi-Light WiFi iBox is needed)



Model No.: LS1 4 IN 1 Smart LED Controller

Model No.	Input Voltage	Output	Working Temperature	Control Distance	Size
LS1	DC12V-24V	Max. 6A/Channel Total output Max. 15A	-20-60°C	30m	138*22.5*35mm

Features

2.4GHz RF remote controllable, WiFi enabled smart phone control. Dimmable & color temperature adjustable color changing & saturation control. With the function of automatic signal transmitting, one can send signal to another, which makes the distance limitless.

99-Zone
One remote can control many track lights at the same time or individually, totally up to 99-zone, up to 9999 lights.

2.4GHz RF Transmission Tech
Low power consumption, long distance control, anti-interference, and high communication speed.

Optional: RGBW / Dual White / Single White
Dimmable & Color temperature Adjustable, Color Changing & Saturation Control.

Smart phone App control
Mi-Light WiFi iBox is needed

Auto-transmitting function
One can send signal to another, which makes the distance limitless.



Remote Controller
Model No.: FUT090



APP control
WiFi iBox is needed

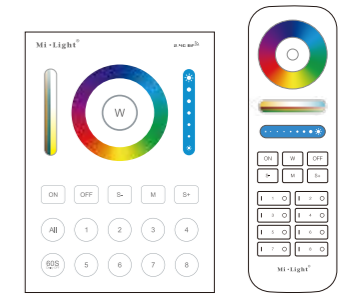

B8

FUT089

Model No.: LS2 5 IN 1 Smart LED Controller

Model No.	Input Voltage	Output	Working Temperature	Control Distance	Size
LS2	DC12V-24V	Max. 6A/Channel Total output Max. 15A	-20-60°C	30m	124*38*23mm

5 in 1 (RGB+CCT / RGBW / Dual White / Single White), controlled by wireless remote controller, also with smart phone control and 4G long distance control (need WiFi box). Dimmable & Color temperature Adjustable, Color Changing & Saturation Control. The controller has auto-transmitting and auto-synchronizing function

2.4GHz RF Transmission Tech
Low power consumption, long distance control, anti-interference, and high communication speed.

Optional: RGB+CCT / RGBW / Dual White / Single White
Dimmable & Color temperature Adjustable, Color Changing & Saturation Control.

Smart phone App control
Mi-Light WiFi iBox is needed

Auto-transmitting function
One can send signal to another, which makes the distance limitless.

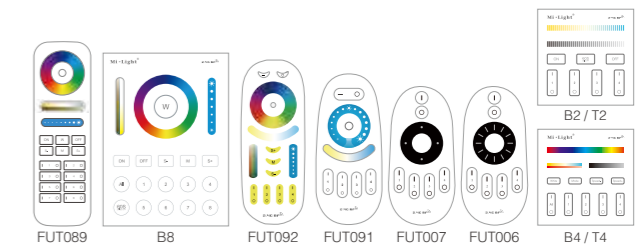
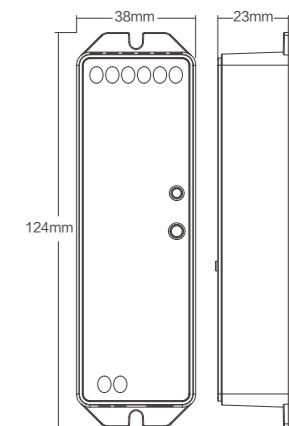

FUT089

B8

FUT092

FUT091

FUT007

FUT006

B2 / T2

B4 / T4

Model No.: LS3 Dual White Panel Light Control System

Model No.	Input Voltage	Output Voltage	Output Current	Working Temperature	Control Distance	Size
LS3	DC42V-45V	DC30V-40V	900mA	-20-60°C	30m	124*38*23mm

The controller has auto-transmitting function and with CCT and Brightness output mode. Controlled by wireless 2.4GHz RF remote controller, also with smart phone control and 4G long distance control (need WiFi box).

2.4GHz RF Transmission Tech
Low power consumption, long distance control, anti-interference, and high communication speed.

Optional: Dual White / Single White
Dimmable & Color temperature adjustable

Smart phone App control
Mi-Light WiFi iBox is needed

Auto-transmitting function
One can send signal to another, which makes the distance limitless.

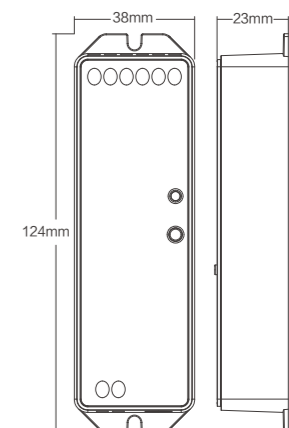

SMART LED Strip Controller

2.4GHz RF remote controllable
Smart phone APP long distance control
(Mi-Light WiFi iBox is needed)

FUT035



4-Zone Dual White LED Strip Controller

- 2.4GHz RF remote controllable, control distance within 30 meters
- Dimmable & color temperature adjustable
- Smart phone APP control (Mi-Light WiFi iBox is needed)



Model No.	Input Voltage	Output	Control Distance	Size
FUT035	DC12V-24V	Max. 6A/Channel Total output Max. 10A	30m	Controller: 85*45*22.5mm

FUT036



4-Zone Single Color LED Strip Controller

- 2.4GHz RF remote controllable, control distance within 30 meters
- Brightness Dimming
- Smart phone APP control (Mi-Light WiFi iBox is needed)

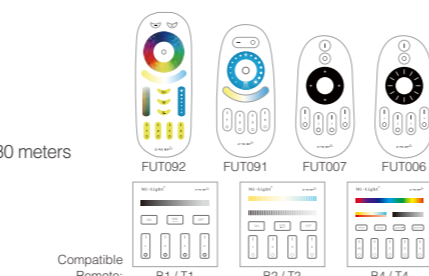

Model No.	Input Voltage	Output	Control Distance	Size
FUT036	DC12V-24V	Max. 6A/Channel Total output Max. 10A	30m	Controller: 85*45*22.5mm

FUT037



4-Zone RGB LED Strip Controller

- 2.4GHz RF remote controllable, control distance within 30 meters
- RGB color changing & brightness dimmable
- Smart phone APP control (Mi-Light WiFi iBox is needed)



Model No.	Input Voltage	Output	Control Distance	Size
FUT037	DC12V-24V	Max. 6A/Channel Total output Max. 10A	30m	Controller: 85*45*22.5mm

FUT038



4-Zone RGBW LED Strip Controller

- 2.4GHz RF remote controllable, control distance within 30 meters
- RGB+W Color changing & Brightness Dimmable
- Smart phone APP control (Mi-Light WiFi iBox is needed)



Model No.	Input Voltage	Output	Control Distance	Size
FUT038	DC12V-24V	Max. 6A/Channel Total output Max. 10A	30m	Controller: 85*45*22.5mm

FUT039



4-Zone RGB+CCT LED Strip Controller

- Dimmable & color temperature adjustable, color changing & saturation control.
- 2.4GHz RF remote controllable, control distance within 30 meters
- Smart phone APP control (Mi-Light WiFi iBox is needed)

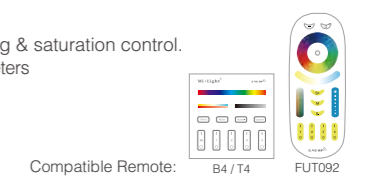

Model No.	Input Voltage	Output	Control Distance	Size
FUT039	DC12V-24V	Max. 6A/Channel Total output Max. 10A	30m	Controller: 85*45*22.5mm

PA4



4-Channel High Performance Amplifier

Amplifying the receiving signals, the strip lights can extend to limitless length



Model No.	Input Voltage	Output	Output Connection	Size
PA4	DC12V-24V	Max. 6A/Channel Total output Max. 15A	Common anode	119*22.5*46.5mm

SMART LED Strip Control System

2.4GHz RF remote controllable
Smart phone APP long distance control
(Mi-Light WiFi iBox is needed)



Model No.: FUT043 RGB LED Strip Control System

- RGB color adjustable
- Color temperature adjustable
- Dimmable Saturation control
- 2.4G RF wireless transmission technology
- Remote control Control distance 30m
- Smart phone App control Mi-Light WiFi iBox is needed

Model No.: FUT044 RGBW LED Strip Control System

- RGB color adjustable
- Color temperature 2700K / 6500K
- Dimmable Saturation control
- 2.4G RF wireless transmission technology
- Remote control Control distance 30m
- Smart phone App control Mi-Light WiFi iBox is needed

Model No.: FUT045 RGB+CCT LED Strip Control System

- RGB color adjustable
- Color temperature 2700~6500K
- Dimmable Saturation control
- 2.4G RF wireless transmission technology
- Remote control Control distance 30m
- Smart phone App control Mi-Light WiFi iBox is needed

Parameters

Model No.	Input Voltage	Output	Control Distance
FUT043/ FUT044 / FUT045	DC12V~24V	Max. 6A/Channel Total output Max.15A	30m



Compatible:
BO Panel Remote Controller

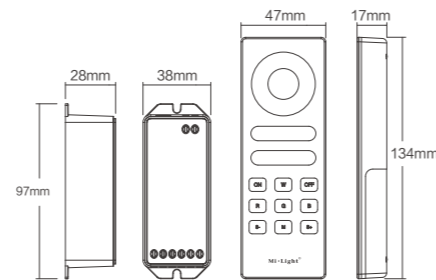

FUT020



FUT021



FUT022



FUT025



FUT027



FUT028



RGB LED Strip Control System

- RGB color changing & brightness dimmable
- 2.4GHz RF remote controllable, control distance within 30 meters
- Smart phone APP control (Mi-Light WiFi iBox is needed)



Model No.	Input Voltage	Output	Control Distance	Size
FUT020	DC12V~24V	Max. 6A/Channel Total output Max.10A	30m	Controller: 85*45*22.5mm Remote: 114*55.5*21.5mm

Single Color LED Strip Control System

- Brightness Dimmable
- 2.4GHz RF remote controllable, control distance within 30 meters
- Smart phone APP control (Mi-Light WiFi iBox is needed)



Model No.	Input Voltage	Output	Control Distance	Size
FUT021	DC12V~24V	Max. 6A/Channel Total output Max.10A	30m	Controller: 85*45*22.5mm Remote: 114*55.5*21.5mm

Dual White LED Strip Control System

- Dimmable & Color temperature Adjustable
- 2.4GHz RF remote controllable, control distance within 30 meters
- Smart phone APP control (Mi-Light WiFi iBox is needed)



Model No.	Input Voltage	Output	Control Distance	Size
FUT022	DC12V~24V	Max. 6A/Channel Total output Max.10A	30m	Controller: 85*45*22.5mm Remote: 114*55.5*21.5mm

Touch RGB LED Strip Control System

- RGB Color changing & Brightness Dimmable
- 2.4GHz RF remote controllable, control distance within 30 meters
- Smart phone APP control (Mi-Light WiFi iBox is needed)



Model No.	Input Voltage	Output	Control Distance	Size
FUT025	DC12V~24V	Max. 6A/Channel Total output Max.10A	30m	Controller: 85*45*22.5mm Remote: 110*53*20.5mm

Touch RGBW LED Strip Control System

- RGB+W Color changing & Brightness Dimmable
- 2.4GHz RF remote controllable, control distance within 30 meters
- Smart phone APP control (Mi-Light WiFi iBox is needed)



Model No.	Input Voltage	Output	Control Distance	Size
FUT027	DC12V~24V	Max. 6A/Channel Total output Max.10A	30m	Controller: 85*45*22.5mm Remote: 114*55.5*21.5mm

RGBW Auto Transmitting&Synchronizing LED Strip Control System

- RGB+W Color changing & Brightness Dimmable
- 2.4GHz RF remote controllable, control distance within 30 meters
- Smart phone APP control (Mi-Light WiFi iBox is needed)



Model No.	Input Voltage	Output	Control Distance	Size
FUT028	DC12V~24V	Max. 6A/Channel Total output Max.10A	30m	Controller: 85*45*22.5mm Remote: 114*55.5*21.5mm



Alpha Lite

The ONE and ONLY smart LED track light manufacturer worldwide 2.4GHz RF remote controllable, WiFi enabled, Angles adjustable with RF remote



-  **99-Zone**
One remote can control many track lights at the same time or individually, totally up to 99-zone, up to 9999 lights.
-  **Directions**
Rotating directions freely, horizontal 350; vertical 180; all your needs can be realized by remote control.
-  **Optional: RGBW / Dual White / Single White**
Dimmable & Color temperature Adjustable, Color Changing & Saturation Control.
-  **2.4GHz RF Transmission Tech**
Low power consumption, long distance control, anti-interference, and high communication speed.
-  **Memory**
You can save and choose color, and the direction of the tracklights.
-  **LCD Screen**
With the LCD screen, you can see the color rate, kelvin, saturation rate, brightness clearly.
-  **Smart phone App control**
Mi-Light WiFi iBox is needed

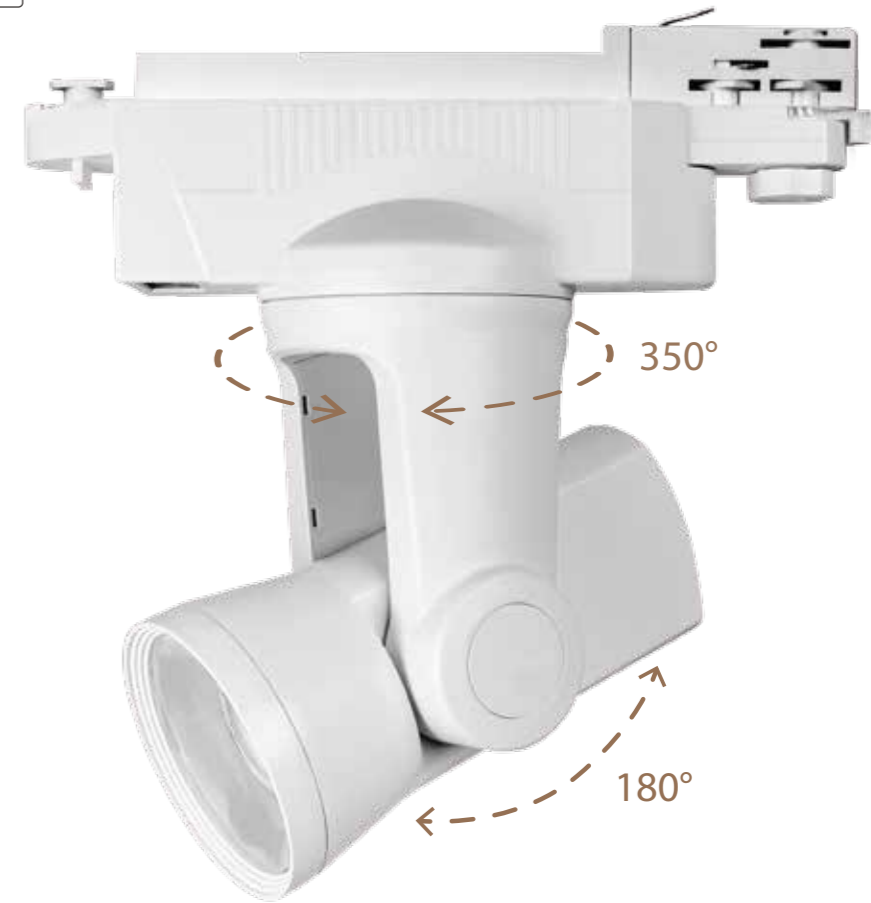

Alpha lite (Single White)

Model No.: AL1(2-wire) / AL4(4-wire)
Power: 25W
Voltage: AC86~265V / 50~60Hz
Kelvin: 2700~3200K / 6000~6500K
Luminous Flux: 2000LM
Luminous Efficiency: 85LM/W
CRI: >90
Beam Angle: 30°
PF: >0.9
Material: Aluminum+Transparent lens
Control Distance: 30m

Alpha lite (Dual White)

Model No.: AL2(2-wire) / AL5(4-wire)
Power: 25W
Voltage: AC86~265V / 50~60Hz
Kelvin: 2700~6500K
Luminous Flux: 2200LM
Luminous Efficiency: 90LM/W
CRI: >80
Beam Angle: 30°
PF: >0.9
Material: Aluminum+Transparent lens
Control Distance: 30m

Alpha lite (RGBW)

Model No.: AL3(2-wire) / AL6(4-wire)
Power: 25W
Voltage: AC86~265V / 50~60Hz
Kelvin: 2700~3200K / 6000~6500K
Luminous Flux: 2020LM
Luminous Efficiency: 85LM/W
CRI: >80
Beam Angle: 30°
PF: >0.9
Material: Aluminum+Transparent lens
Control Distance: 30m



Horizontal 350° Rotating



Vertical 180° Rotating



Digital Screen

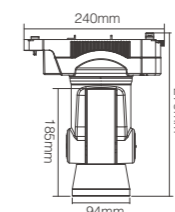

2-wire

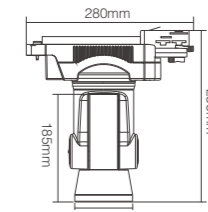

4-wire



Remote Controller
Model No.: FUT090



APP control
WiFi iBox is needed

Smart Panel Controller

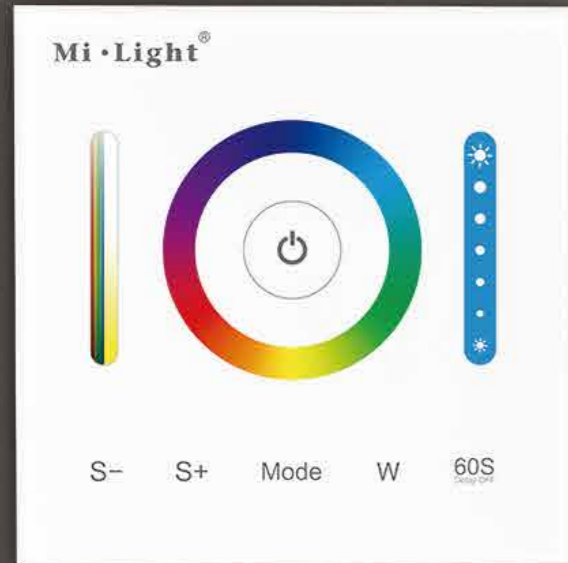

Features

Smart Panel Controller is a newly high-end controller. The appearance is made of a pretty and fashionable glass panels. And we adopt a high precision Capacitive touch screen IC. Touch Screen is very stable. Also It has memory function (Turn off the light, then turn on again, The lamps will keep the same light as before). This controller widely work on Single Color, CCT, RGB, RGBW and RGB+CCT LED strip. Also work on Flexible strip, Panel light, Rolling strip. Easily install and operate.

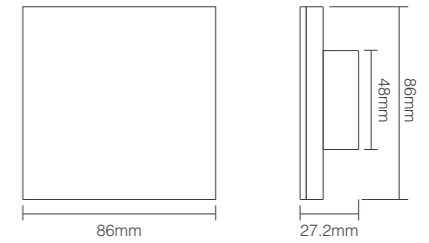

Parameters

Model No.	Input Voltage	Output	Working Temperature	Output Connection	Size
P1 / P2 / P3	DC12-24V	Max. 6A/Channel Total output Max.15A	-20 -60°C	Common anode	86*86*27.2mm

P1



Single Color Smart Panel Controller Model No.: P1

- Brightness Dimming, 9 modes switching
- LED night indicating lamp
- Adopt a high precision capacitive touch screen IC, touch screen is very stable



P2

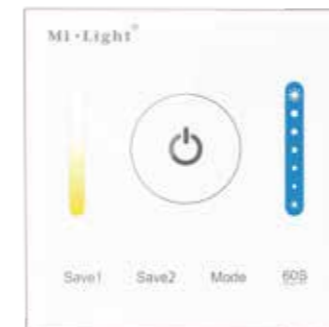

Dual White Smart Panel Controller Model No.: P2

- Dimmable and color temperature adjustable
- Two types User defined Save color, 9 modes switching
- LED night indicating lamp
- Adopt a high precision capacitive touch screen IC, touch screen is very stable



P3

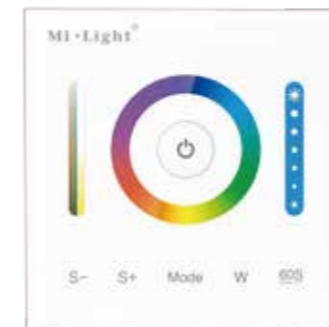

3 in 1 (RGB&RGBW&RGB+CCT) Smart Panel Controller Model No.: P3



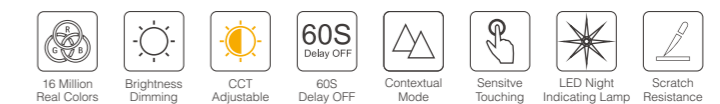



- This controller is compatible with RGB, RGBW and RGB+CCT version it will be RGBW Version when you get it first time.
- Dimmable & color temperature adjustable, color changing & saturation control
- 12 modes switching, LED night indicating lamp





Features

Adopt world-wide used 2.4GHz frequency, GFSK control method, with the features of low power consumption, long distance transmitting, strong anti-interference and fast communication rate; can control specified Mi-Light smart light with color, color temperature, saturation and brightness changing.

- 
8-Zone Area
each zone no qty limited bulb
- 
60S Delay OFF
60S Delay OFF
- 
High-precision touching IC
is more stable and sensitive
- 
RGB+CCT
16 millions of colors to choose
- 
Color temperature adjustable
- 
Dimmable saturation control
- 
2.4G RF wireless transmission technology

B8

8-Zone Smart Panel Remote Controller

Model No.	Power	Input Voltage	Transmission Frequency	Modulation Method	Control Distance
B8	Power Consumption: 6dBm Standby Power Consumption: 30uA	3V (Sevion 2 Battery) / DC 3.3V	2.4GHz	GFSK	30m

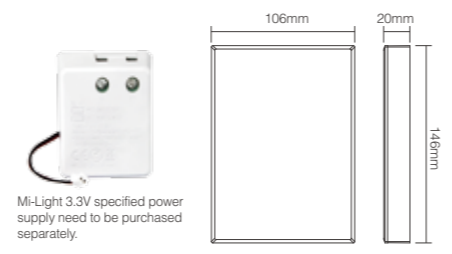

Mi-Light 3.3V specified power supply need to be purchased separately.

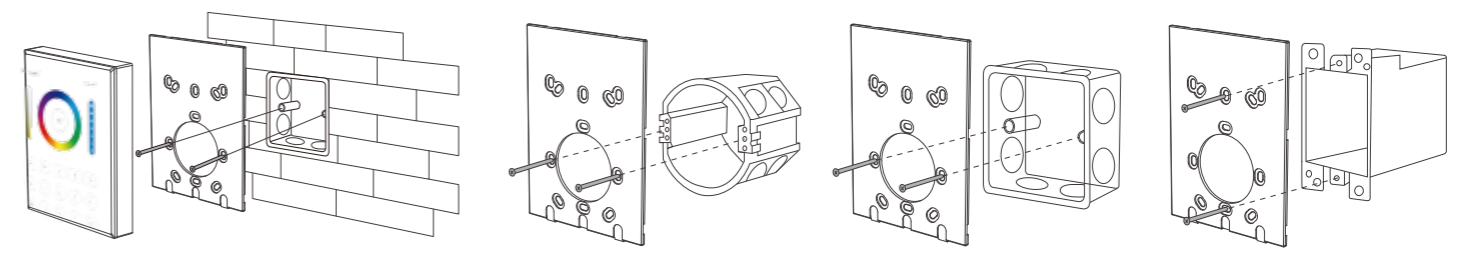

Panel Remote Controller

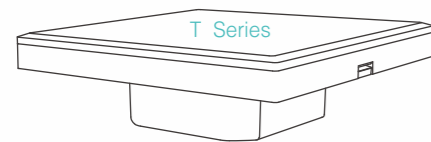
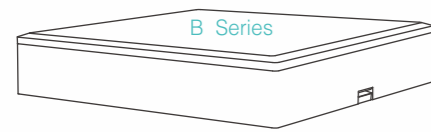

The appearance is made of a pretty and fashionable glass panel

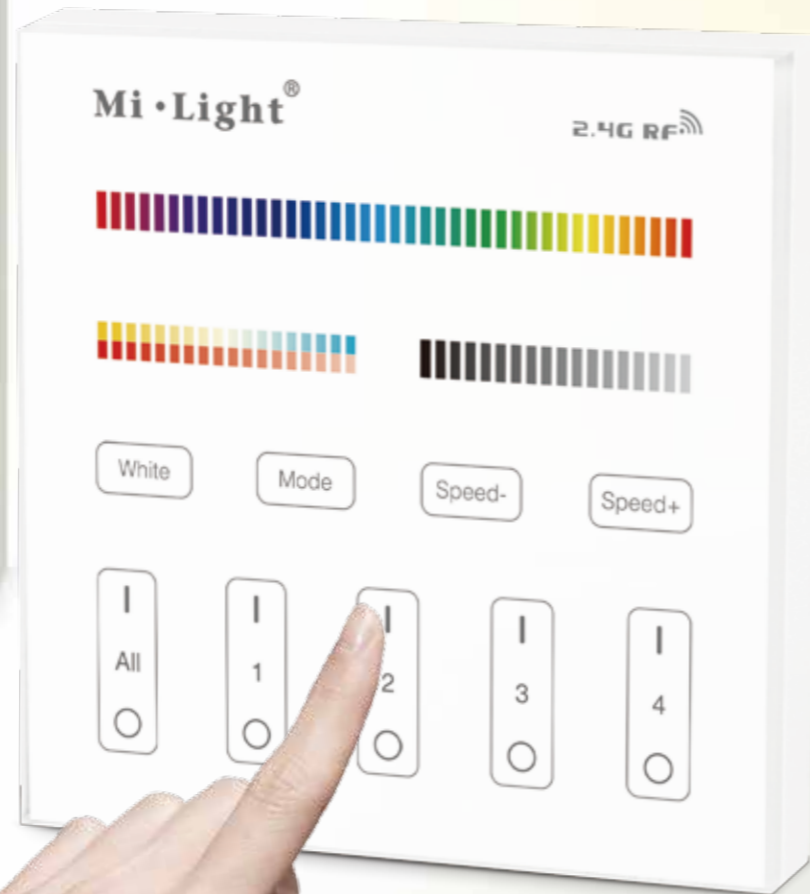

Features

This Panel Remote Controller is designed by a delicate and fashionable tempered glass panel; And we adopt a high precision Capacitive touch screen IC. Touch Screen is very stable; 2.4Ghz high RF wireless control with long distance controlling, low power consumption and high speed transmitting rate. This product has T series and P series, and the difference is the method of power supplying. Both series have 4 kinds: T1/B1 4-zone Brightness dimming panel remote controller; T2/B2 4-zone CCT panel remote controller; T3/B3 4-zone RGB/RGBW panel remote controller; T4/B4 4-zone RGB+CCT panel remote controller. This product widely work on our smart LED Lighting, LED Controller and Smart panel controller, etc.

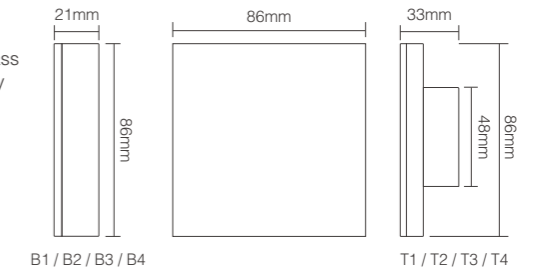

Parameters

Model No.	Power	Input Voltage	Transmission Frequency	Modulation Method	Control Distance	Size
B1 / B2 / B3 / B4	Transmitting Power: 6dBm Standby Power Consumption: 10uA	3V (Sevion 2 Battery)	2.4GHz	GFSK	30m	86*86*21mm
T1 / T2 / T3 / T4	Transmitting Power: 6dBm	AC90~120V / AC180~240V	2.4GHz	GFSK	30m	86*86*33mm

B1/T1



4-Zone Single Color Panel Remote Controller Model No.: B1 / T1

- Brightness Dimming
- Individided 4-zone group lighting separately, no bulb qty limited
- Adopt a hight precision capacitive touch screen IC, touch screen is very stable

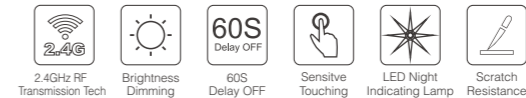

B2/T2



4-Zone Dual White Panel Remote Controller Model No.: B2 / T2

- Dimmable and color temperature adjustable
- Individided 4-zone group lighting separately, no bulb qty limited
- Adopt a hight precision capacitive touch screen IC, touch screen is very stable

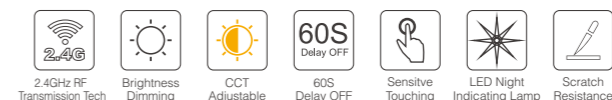

B3/T3

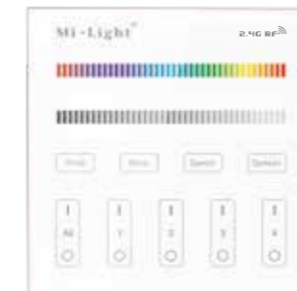

4-Zone RGBW Panel Remote Controller Model No.: B3 / T3

- RGB+W Color changing, brightness & saturation control, 9 modes switching
- Individided 4-zone group lighting separately, no bulb qty limited
- Adopt a hight precision capacitive touch screen IC, touch screen is very stable



B4/T4

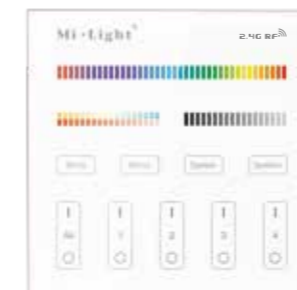

4-Zone RGB+CCT Panel Remote Controller Model No.: B4 / T4

- Dimmable & color temperature adjustable, color changing & saturation control 9 modes switching
- Individided 4-zone group lighting separately, no bulb qty limited
- Adopt a hight precision capacitive touch screen IC, touch screen is very stable



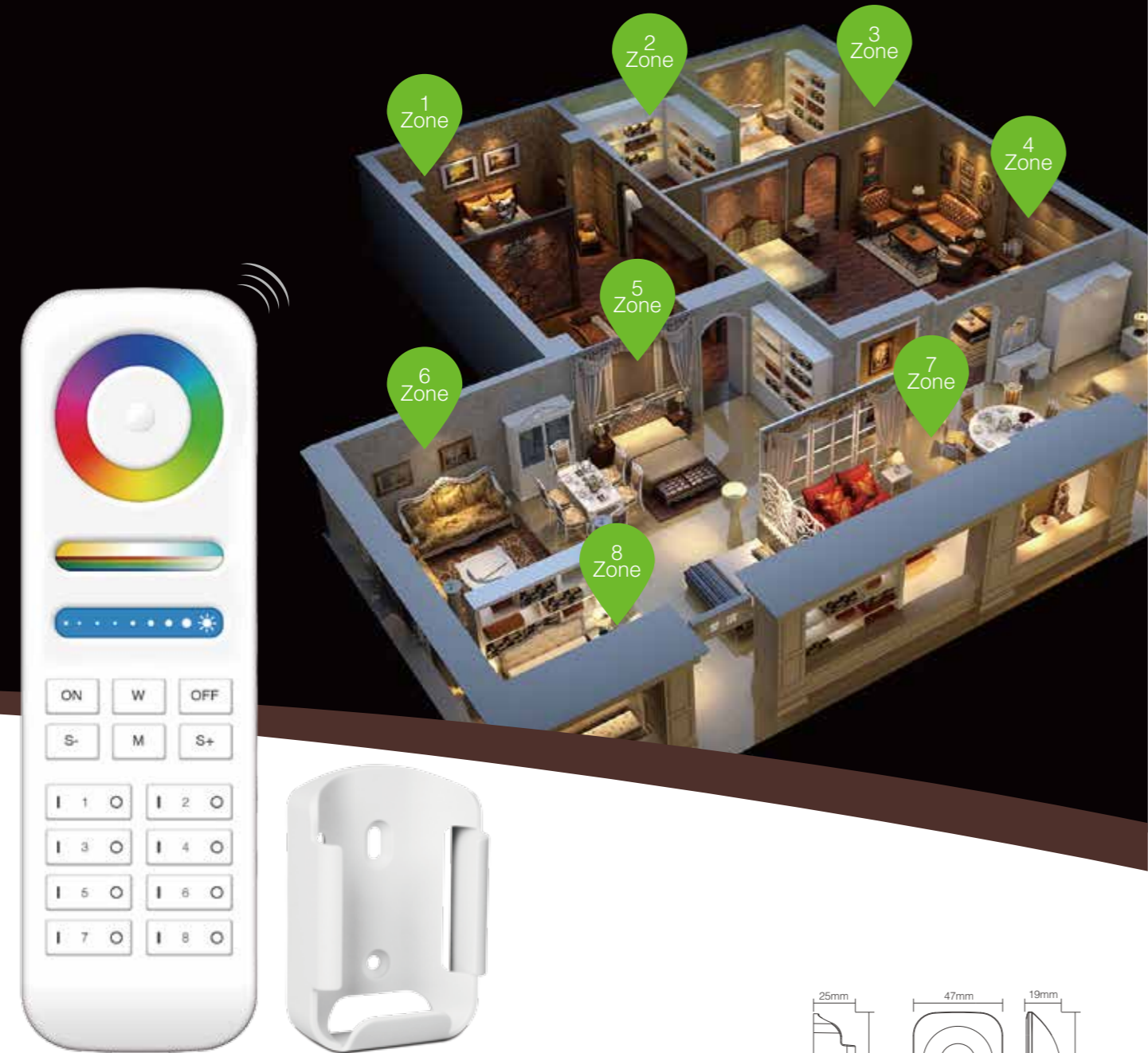

FUT089 8-Zone RGB+CCT Remote Control

Model No.	Power	Voltage	Transmission Frequency	Modulation Method	Control Distance
FUT089	Power Consumption: 6dBm Standby Power Consumption: 20uA	3V(Sevtion 2 Battery)	2.4GHz	GFSK	30m

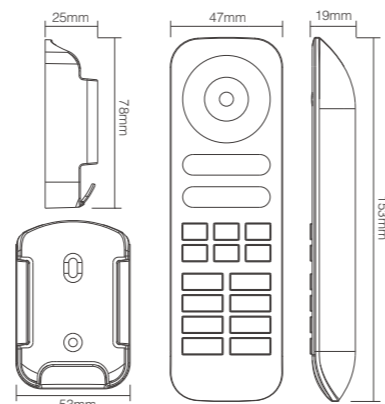

Features

Adopt world-wide used 2.4GHz frequency, GFSK control method, with the features of low power consumption, long distance transmitting, strong anti-interference and fast communication rate; can control specified Mi-Light smart light with color, color temperature, saturation and brightness changing.

- 8-Zone Area
Each zone no qty limited bulb
- RGB+CCT
16 Millions of colors to choose
- Color temperature adjustable
- Dimmable
Saturation control
- 2.4G RF wireless transmission technology

Remote Control Parameters

Model No.	Power	Voltage	Transmission Frequency	Modulation Method	Control Distance
FUT006 / FUT007 / FUT091 / FUT092 FUT093 / FUT095 / FUT096 / FUT098	Power Consumption: 6dBm Standby Power Consumption: 20uA	3V(Sevtion 2 Battery)	2.4GHz	GFSK	30m
FUT090	Power Consumption: 6dBm Standby Power Consumption: 30uA	4.5V(Sevtion 3 Battery)	2.4GHz	GFSK	30m



Model No.: FUT006 4-Zone Rotating Wheel Remote Control

- Dimmable and color temperature adjustable
- Invided 4-zone group lightng separately, no bulb qty limited



Model No.: FUT007 4-Zone Dual White Remote Control

- Dimmable and color temperature adjustable
- Invided 4-zone group lightng separately, no bulb qty limited



Model No.: FUT091 4-Zone Touch Dual White Remote Control

- Dimmable and color temperature adjustable
- Invided 4-zone group lightng separately, no bulb qty limited



Model No.: FUT092 4-Zone RGB+CCT Remote Controller

- Dimmable & color temperature adjustable, color changing & saturation control
- Invided 4-zone group lightng separately, no bulb qty limited



Model No.: FUT095 4-Zone RGBW Remote Control With Button

- RGB+W Color changing, brightness control
- Invided 4-zone group lightng separately, no bulb qty limited



Model No.: FUT096 4-Zone Touch RGBW Remote Control

- RGB+W Color changing, brightness control
- Invided 4-zone group lightng separately, no bulb qty limited



Model No.: FUT098 Touch RGB Remote Control

- RGB Color changing, brightness control
- Control distance 30 meters

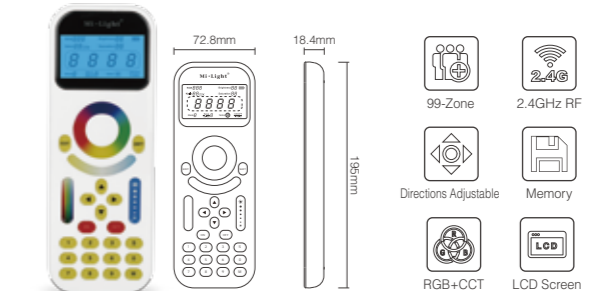

Model No.: FUT090 Remote Control for LED Tracklight

- Dimmable & color temperature adjustable, color changing & saturation control. Directions adjustable with RF remote, directions or colors can be saved. 99 zones, control distance 30 meters.

WiFi iBox

Compatible with
all Mi-light 2.4GHz series



Features

Compatible with all Mi-light 2.4GHz series

iBox is an upgraded WiFi box for Mi-light series. The APP has new UI faces, and new functions. With easy link to the wifi router, you will be able to control the lights anywhere.

Long Distance Control

You can control your lights anywhere with your 3G/4G/wifi on your phone.

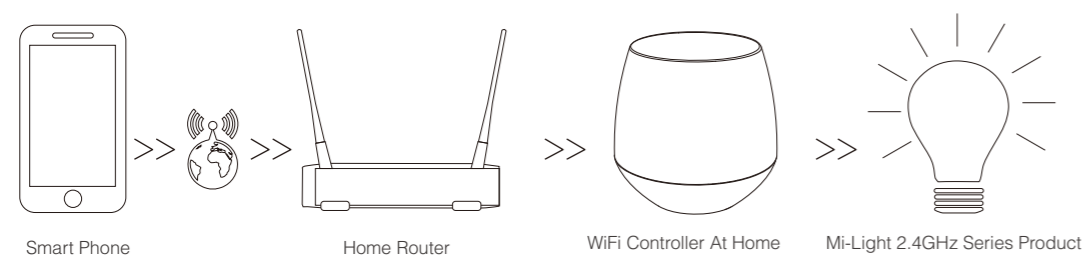

iBox1

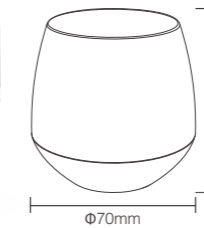

iBox2

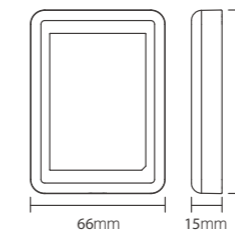

Model No.	Power	Input	Protocol	Control Distance
iBox1	2W	Micro USB DC5V / 500mA	2.4GHz, WiFi-IEEE 802.11b/g/n	30m



App Long Distance Control

With WiFi & Smart phone APP, you can control the lights anywhere, compatible with iOS, Android 4.3 or above.



Compatibility

2.4GHz RF Chip, compatible with all Mi-light series.



Which is an exquisite light itself

16 Millions of colors to choose, Brightness Dimming.



Timer Function

Automatic ON/OFF with timer function.

Model No.	Input	Protocol	Control Distance
iBox2	Micro USB DC5V / 500mA	2.4GHz, WiFi-IEEE 802.11b/g/n	30m



App Long Distance Control

With WiFi & Smart phone APP, you can control the lights anywhere, compatible with iOS, Android 4.3 or above.



Compatibility

2.4GHz RF Chip, compatible with all Mi-light series.



Timer Function

Automatic ON/OFF with timer function.



APP Download

Search "Milight" from Apple store, or scan the code shown on the left.

Search "Milight" from Google Play store, or scan the code shown on the left. (Android 4.3 or above.)

SMART LED Dimming Driver

2.4GHz RF remote controllable
Smart phone APP long distance control
(Mi-Light WiFi iBox is needed)



Model No.: LS4

0/1~10V Dimming Driver

Model No.	Input Voltage	Output Current	Input Signal	Dimming Range	Working Temperature	Remote Control Distance
LS4	DC 12~24V	12A	0/1~10V / 10V PWM / Push Dimming	0~100%	-20~60°C	30m

Features

0~10V / 1~10V/ 10V PWM / Push Dimming controllable, 2.4GHz Remote controllable (0~100%) Adjust the brightness smoothly



Dimmable (0~100%)



Adjust the brightness through 0~10V / 1~10V Dimmer



Adjust the brightness through Push Button



2.4GHz RF Remote control
Control distance 30m



Smart phone APP control
Mi.Light WiFi iBox is needed



Auto-transmitting function

Compatible Remote:

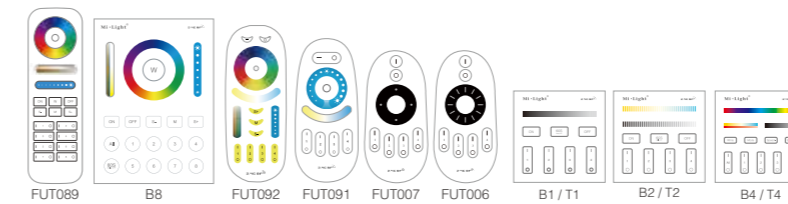

Automatic Commands Transmitting Function

One controller can transmit the signals from the remote control to another controller within 30m, as long as there is a controller within 30m, the remote control distance can be limitless.

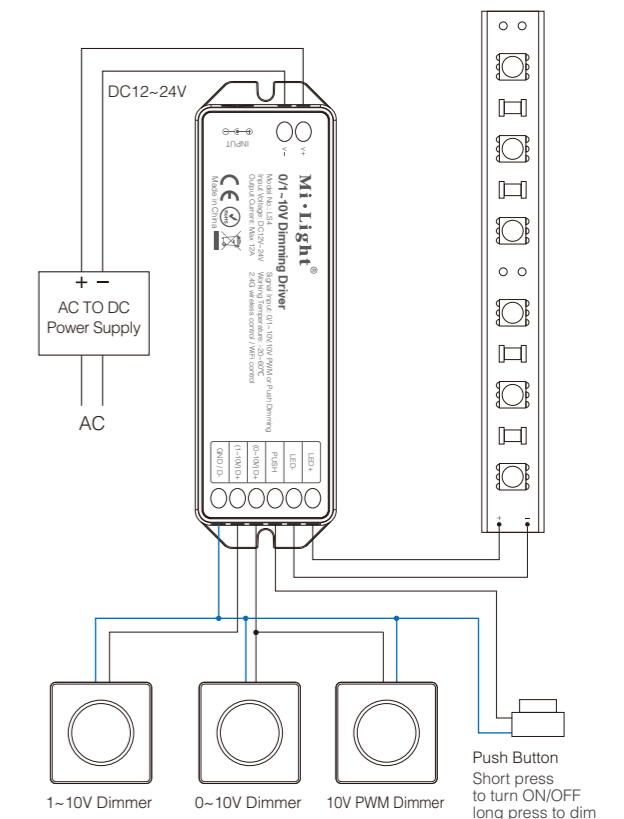
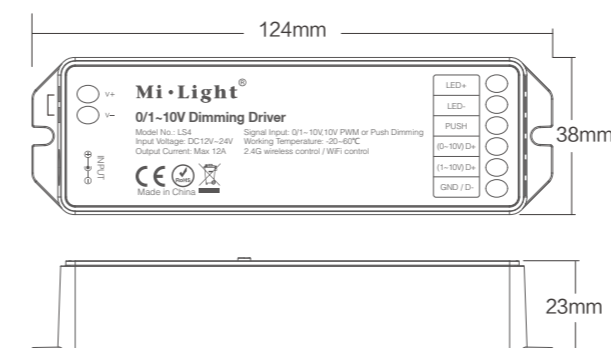
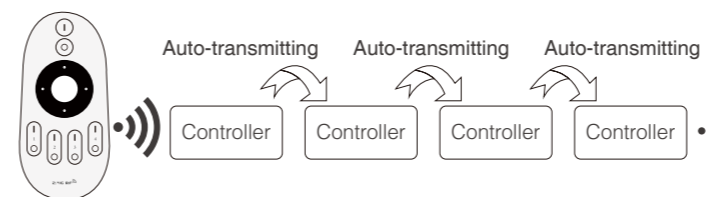

DMX512 Series

Wireless Control

By adopting the 2.4G global ISM frequency, the data is more reliable and has no delay during the transmitting



Model No.: FUTD01

DMX 512 LED Transmitter

DMX512 LED transmitter can send standard DMX512 protocol data by wireless.

It is used to transmit the wireless data between DMX512 control panel and our DMX512 light bulb or led strip light controller series.

By adopting the 2.4G global ISM frequency, the data is more reliable and has no delay during the transmitting.

Model No.	Power	Input	Frequency	Transmitting Method	Distance	Size
FUTD01	6dBm	DC5V / 500mA	2400-2483.5MHz	GFSK	30m	188*47*23mm

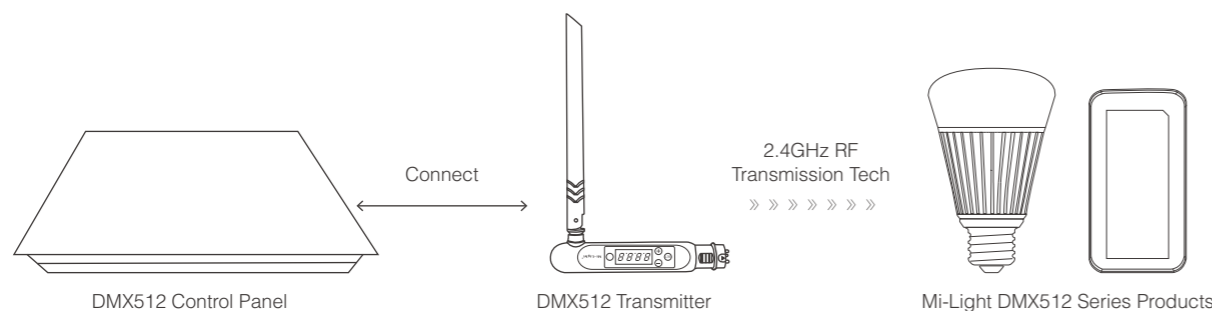

FUTD02

DMX512 RGB+CCT Strip Controller

- 16 million colors to choose, Brightness Dimming, color temperature and saturation.
- DMX 512 LED transmitter & 2.4GHz RF remote controllable,
- Control distance within 30 meters
- Smart phone APP control, long distance control (Mi-Light WiFi iBox is needed)

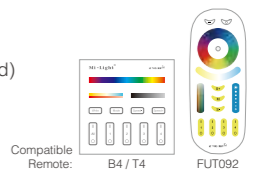

Model No.	Input	Output	Control Distance	Size
FUTD02	DC12-24V	Max. 6A/Channel Total output Max. 10A	30m	85*45*22.5mm



FUTD03

DMX512 RGB+CCT LED Light Bulb

- 16 million colors to choose, Brightness Dimming, color temperature and saturation.
- DMX 512 LED transmitter & 2.4GHz RF remote controllable,
- Control distance within 30 meters
- Smart phone APP control, long distance control (Mi-Light WiFi iBox is needed)

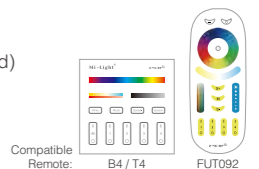

Model No.	Voltage	Kelvin	Luminous Flux	Light Efficiency	CRI	PF	Beam angle	Base Type
FUTD03	AC86-265V 50-60Hz	2700-6500K	500-550LM	70LM/W	>80	0.65	230°	E26 / E27 B22