	20KW/50KWH Integrated System for High- voltage Optical Storage Operator manual	Filename	202310611
		Authorized date	2023-09-28
		File Edition	V1.0
		Page number	Page 1 of 4 6

20KW/50KWH AiO Integrated High Voltage Storage System Operation Manual



	20KW/50KWH High-voltage Optical Storage Integrated System Operator manual	filename	202310611
		Authorization date	2023-09-28
		Document Edition	V1.0
		page number	2Page 1 of 19 pages28

Catalogue

1. About this manual.....	3
1.1. Writing purpose	3
1.2. Project background	3
1.3. Terms and abbreviations	3
2. System configuration information	3
3. Safety notes.....	4
3.1 Application scope of the products	4
3.2 Safe use instructions	4
3.3 Notes in the operation	5
4. System introduction	9
4.1 Structural composition	9
4.2 Communication scheme	9
4.3 Principle of high-voltage photovoltaic energy storage system	9
5. System assembling.....	11
5.1 AC-side installation	11
5.2 PV side installation	12
5.3 WiFi data collector installation	13
6. Switch and switch machine operation	14
6.1 Boot	14
6.2 Starting operation process of high voltage optical storage system	15
6.3 The PCS operation	20
6.4 PCS LCD screen icon	21
6.5 APP operation	36
6.6 Shutdown	37
6.7 Technical parameters	41
7. Daily maintenance and inspection.....	43
7.1 Safety precautions	43
7.2 Maintenance work and cycle	43
7.3 Battery Maintenance Guide	45
7.4 Replacement of the electronic and electrical components	46

	20KW/50KWH High-voltage Optical Storage Integrated System Operator manual	filename	202310611
		Authorization date	2023-09-28
		Document Edition	V1.0
		page number	3Page 1 of 19 pages28

1. About this manual

1.1. Writing purpose

The purpose of writing this instruction is to fully describe the functions of the equipment and its operating environment, so that the user can understand the use scope and use method of the equipment, and to provide the necessary information for the simple maintenance and update of the equipment.

Note: This equipment is suitable for the use of users after commissioning, and does not involve installation and commissioning.

1.2. Project background

The high voltage optical storage integrated system (hereinafter referred to as the system) can be flexibly and quickly configured according to customer needs, which can maximize the spontaneous self-use rate of the photovoltaic system and the charging and discharging capacity of the battery. Its compact integrated module design, more simple and light, greatly convenient for transportation and on-site installation.

Integrated MPPT, two-way inverter, BMS, high-performance battery and intelligence, with fast charging and discharging function, enabling users to charge and release energy more quickly. In addition, the hybrid inverter part of the product also adopts intelligent AC-DC coupling technology to realize efficient energy conversion and utilization and maximize the energy utilization. This not only improves the overall performance of the system, but also reduces energy waste

The system can be connected to the smart energy cloud management platform, and users can intelligently connect with the all-in-one machine through the APP, facilitating users to monitor the real-time running status and historical statistics of the device anytime and anywhere;

1.3, terms and abbreviations

System: high-voltage light storage integrated system

BMU: Battery information acquisition module (part of the BMS)

BCU: Battery Secondary Master Module (part of the BMS)

PCS: Light storage hybrid inverter

2. System configuration information

Table 1 High-voltage integrated optical storage system			
project	specifications	unit	quantity
cabinet	854*750*2032mm	unit	1
battery pack	64V/100Ah	unit	8

	20KW/50KWH High-voltage Optical Storage Integrated System Operator manual	filename	202310611
		Authorization date	2023-09-28
		Documentation Edition	V1.0
		page number	4Page 1 of 19 pages28

high-voltage compartment	Including BCU, relay, switching power supply, etc	unit	1
Communication side	Including circuit breaker, leakage protection, PCS (20KW), etc	unit	1
fire extinguisher system	fire extinguisher system	unit	1
Start the battery	22.4V12Ah	unit	1
pencil	Including power wire harness, communication wire harness	unit	1
fittings of a machine	Ring (4), PCS instructions for use (1), MC4 female plug (4 sets), key (1 set), CT (3), data bars (2 each, one DEYE / ALAF-AX), SC25-6 copper nose (9), SC25-8 copper nose (8)		

3. Safety notes

3.1 Application scope of the products

Shandong Haidi New Energy Technology Co., LTD. Developed and produced this series of high voltage optical storage integrated system, including cabinet, lithium iron phosphate battery pack, high voltage box, optical storage mixed inverter (20KW), fan, etc. The whole system is IP20 and is suitable for indoor installation. Due to the characteristics of lithium iron phosphate battery, the discharge temperature of the energy storage battery in this project should be in the range of -20℃ ~60℃, the charging temperature should be in the range of 0℃ ~45℃, and the long-term storage temperature is in the -20℃ ~60℃ environment. Beyond this range, the energy storage batteries will cause irreversible damage, affecting the cycle life.

警告

If the system is not installed as described in this subsection, or is installed or modified without authorization, it may be guidedCause safety accidents or equipment damage. Shandong Haidi New Energy Technology Co., Ltd. will not be liable for any loss caused.

3.2 Safe using instructions

This section describes the general safety precautions required when operating the system. For the safety instructions in the simple maintenance steps, see the warning instructions in the corresponding section.

	20KW/50KWH High-voltage Optical Storage Integrated System Operator manual	filename	202310611
		Authorization date	2023-09-28
		Document Edition	V1.0
		page number	5Page 1 of 19 pages28

危险

Do not touch the terminals or conductors connected to the main circuit.

Note all instructions or safety instructions for the main loop connections.

- Deadatual high voltage inside the product!

Note and observe the warning signs on the product.

Observe the safety precautions listed in this manual and other relevant documents of the equipment.

- Damaged equipment or system failure may cause an electric shock or a fire!

Initially visually inspect the equipment for damage or other hazards before operation.

Check that other external equipment or circuit connections are safe.

Verify that the device is in a safe state to operate.

警告

After the maintenance and overhaul, the equipment shall be sent power in strict accordance with the steps in this manual.

3.3 Notes in the operation

3.3.1 Manual storage

This manual contains important information for operating the system. Read this manual carefully before operating the system.

Please operate the system strictly according to the description in this manual, otherwise, it may cause equipment damage, casualties and property damage.

This manual shall be properly maintained to ensure ready access for maintenance, maintenance, etc.

3.3.2 Personnel requirements

Only professional electricians or professional qualified personnel can carry out the operation of the product.

Operators should be fully familiar with the composition and working principle of the entire energy storage system.

Operators shall be fully familiar with the Operation Manual of this product.

The operator shall be fully familiar with the relevant standards of the project country / region.

3.3.3 Protection of body identification

The warning sign in the cabinet contains important information for the safe operation of the system. No artificial tearing or damage is allowed

	20KW/50KWH High-voltage Optical Storage Integrated System Operator manual	filename	202310611
		Authorization date	2023-09-28
		Document Edition	V1.0
		page number	6Page 1 of 19 pages28

注意

Make sure the body logo is clearly readable at all times.
 Once the body logo is damaged or blurred, it must be replaced immediately.

3.3.4 Setting of safety warning signs

In the implementation of the system installation, daily maintenance, overhaul and other operations, in order to prevent irrelevant personnel close and misoperation or accident. Please comply with the following items:

- Set up obvious signs at the system switch to prevent accidents caused by misclosing.
- Set up warning signs or safety warning belts near the operating area.
- After maintenance or maintenance, pull out the door key and keep it properly.

3.3.5 Requirements for escape access

To ensure that staff can evacuate the site quickly in case of accident, please follow the following:

- In the whole process of system maintenance, overhaul and other operations, it is necessary to ensure that the escape passage is completely smooth.
- It is strictly prohibited to pile up debris in the escape passage, or to occupy the escape passage in any form.

3.3.6 Protection and use of energy storage batteries

For energy storage systems, the voltage between the positive and negative electrodes of the energy storage battery pack is very high. If the accidental touch, there will be an electric shock or even life danger. At the same time, due to the characteristics of lithium battery, whether in the use of use, or storage should be within the specified scope of use.

⚠ 危险

There is a fatal high voltage between the positive and negative electrodes of the energy storage battery pack!

When maintaining the equipment, ensure that the connection between the user equipment and the energy storage battery pack is completely disconnected.

3.3.6.1 Use environment of batteries

- (1) Ambient temperature range: charging (0°C ~ + 45°C), discharge (-20°C ~ + 60°C), the temperature where the battery should be kept at 0°C ~45°C as far as possible.
- (2) The battery should avoid heat source, direct sunlight, humidity, possible water immersion and dust places.
- (3) The place where the battery is placed can not be completely closed, should be well ventilated, had better have a ventilation and exhaust device.

3.3.6.2 Conditions of batteries

- (1) Heat dissipation condition: battery spacing of more than 10mm;
- (2) Air ventilation and ventilation conditions: ensure that the ambient hydrogen concentration of the battery is less than 0.8%;
- (3) About capacity expansion or battery replacement: different new and old products with different

	20KW/50KWH High-voltage Optical Storage Integrated System Operator manual	filename	202310611
		Authorizat ion date	2023-09-28
		Document ation Edition	V1.0
		p a g e n u m b e r	7Page 1 of 19 pages28

manufacturers are not allowed to be mixed together;

(4) Optimum ambient temperature: the optimal working ambient temperature of the battery is 0°C ~45°C. If the battery is used outside this temperature range, the performance of the battery may be exerted Some changes, the specific performance for the battery capacity Quantity change or equipment running time change, this is a normal phenomenon.

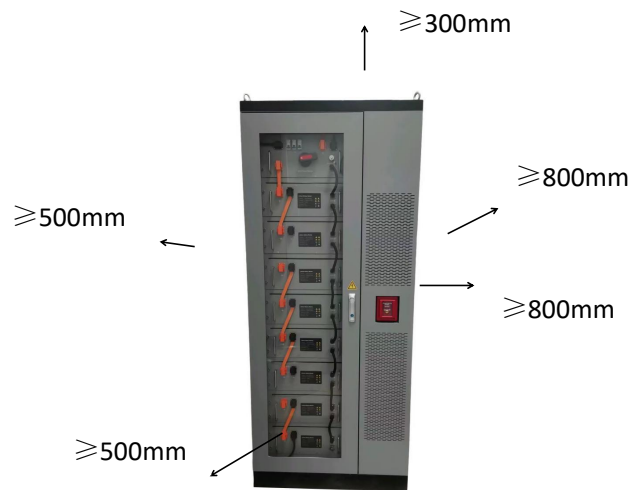

A Schematic diagram of the installation space

3.3.6.3 Notes for operation

- (1) It is strictly prohibited to overcharge and overdischarge the battery;
- (2) No battery placement in a damp, corrosive and dusty environment:
- (3) Without our consent, the customer shall not change any setting parameters in the BMS management system, otherwise it will be fully responsible.
- (4) It is forbidden to use it beyond the allowable range of the system (such as charge / discharge current, voltage range, etc.), and our company will not assume any responsibility after exceeding it.

Note: The customer is strictly prohibited from performing any non-compliant operation on the battery pack (no major failure situation).

3.3.7 Charged measurement

	20KW/50KWH High-voltage Optical Storage Integrated System Operator manual	filename	202310611
		Authorization date	2023-09-28
		Document Edition	V1.0
		page number	8Page 1 of 19 pages28

⚠ 危险

There is high voltage in the equipment, accidental touch may cause fatal shock hazard, so during live measurement shall:

Good protection work (such as wearing insulating gloves, etc.)

There must be escorts to ensure personal safety

3.3.8 Use of measuring equipment

During the system, relevant electrical measuring equipment is required to ensure that the electrical parameters meet the requirements.

⚠ 警告

Select high quality measuring equipment whose range and usable conditions meet the requirements of the site.

Ensure the correct connection and use of measuring equipment, so as to avoid arc and other dangers.

3.3.9 Electrostatic electricity protection

Contact or improper operation of printed circuit boards or other electrostatic sensitive elements can lead to device damage.

Avoid unnecessary circuit board contact.

Observe the static electricity protection specifications, such as wearing an anti-static bracelet, etc.

3.3.10 Moisture protection

注意

The invasion of moisture is highly likely to damage the system! To ensure the normal use of the system functions, please follow the following items:

Do not open the cabinet door when the air humidity is > 95%.

3.3.11 Notes during maintenance or overhaul

After executing the aforementioned shutdown operation, the system has quit operation smoothly, and the following points should be noted when performing the maintenance or overhaul operation of the equipment:

Ensure that the system is not accidentally re-powered on.

Implement the necessary grounding and short-circuit connections.

Insulate the potentially live parts near the operation part with insulating material.

In the whole process of maintenance and overhaul, we need to ensure that the escape passage is completely unblocked.

3.3.12 Product scrap

When the energy storage batteries need to be discarded, they should not be treated as conventional waste products. Please contact Shandong Haidi New Energy Technology Co., Ltd. to provide a professional return service.

3.3.13 Other precautions

	20KW/50KWH High-voltage Optical Storage Integrated System Operator manual	filename	202310611
		Authorization date	2023-09-28
		Document Edition	V1.0
		page number	9Page 1 of 19 pages28

警告

All the operation of the system shall comply with the relevant standards of the project location country / region.

警告

Do not perform maintenance or repair when the equipment is live!

At least two personnel must be ensured on the site when maintaining or repairing the equipment. The maintenance operation can not be performed until the equipment has been safely cut off and discharged.

In addition, the following protective or emergency measures shall be taken at the site:

During the maintenance and overhaul of the equipment, the relevant personnel shall take appropriate protective measures as required, such as wearing insulating gloves, Wear insulated shoes, etc.

Use all necessary auxiliary measures to ensure the safety of personnel and equipment.

All the descriptions in this manual are for small photovoltaic energy storage systems. If you have special needs, please explain to the personnel of Shandong Haidi New Energy Technology Co., LTD, when ordering. For details, please refer to the actual products you have received.

This manual does not cover all possible situations during operation, maintenance, etc. If you fail to explain the situation in the manual, please contact Shandong Haidi New Energy Technology Co., LTD. In time.

4. System introduction

4.1 Structural composition

The system is composed of cabinet, lithium iron phosphate battery pack, high voltage box, light storage hybrid inverter, fire protection system and so on.

4.2 Communication scheme

BMS between BMU and BCU; BMU adopts CAN communication (CAN 1) (CAN 2), and MODBUS RTU (RS485) protocol communication between BCU and fire protection system;

4.3 Principle of high-voltage photovoltaic energy storage system

The schematic diagram of the integrated high-voltage optical storage system is as follows (for China, Germany, Czech Republic, Italy and other countries, please follow the local wiring regulations):

	20KW/50KWH High-voltage Optical Storage Integrated System Operator manual	filename	202310611
		Authorizat ion date	2023-09-28
		Document ation Edition	V1.0
		p a g e n u m b e r	10Page 1 of 19 pages28

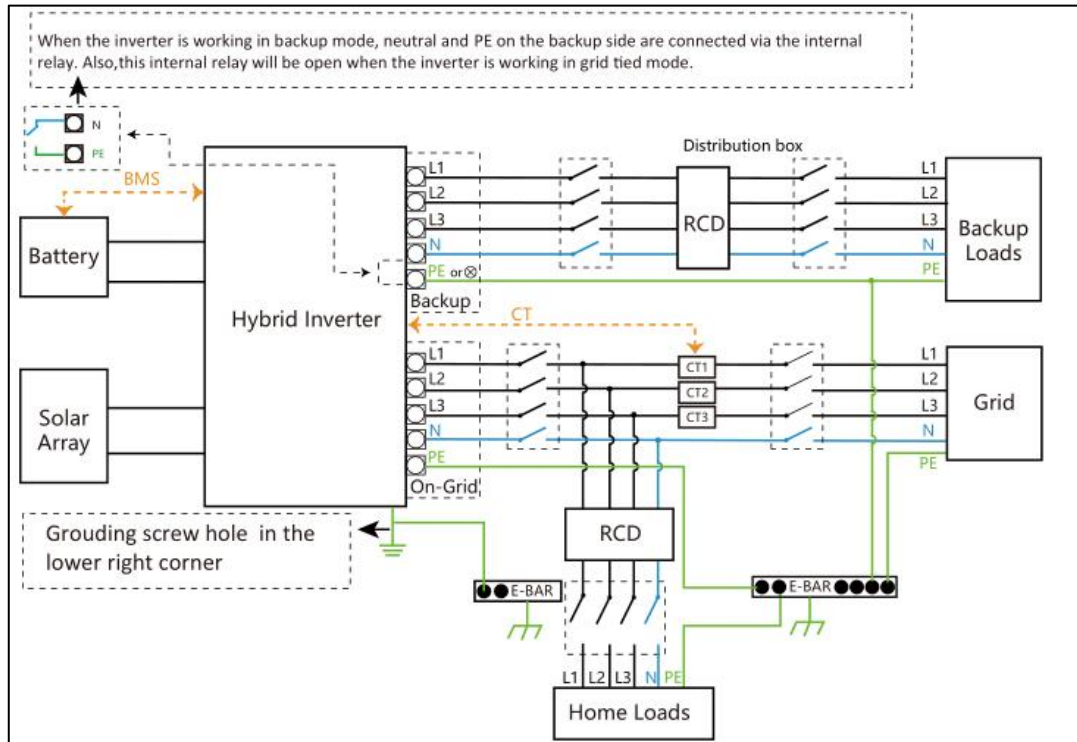

A Schematic diagram of the high-voltage photovoltaic energy storage system

5. system assemble

5.1 AC-side installation

- (1) Remove the AC side small end plate;

	20KW/50KWH High-voltage Optical Storage Integrated System Operator manual	filename	202310611
		Authorizat ion date	2023-09-28
		Document ation Edition	V1.0
		p a g e n u m b e r	11Page 1 of 19 pages28



- (2) Disconnect the main switch of the power grid, and pass the cable through the bottom of the Grid with the CT arrow to the inverter (as shown below); note the order of CT1, CT2 and CT3 as (L1 / L2 / L3);

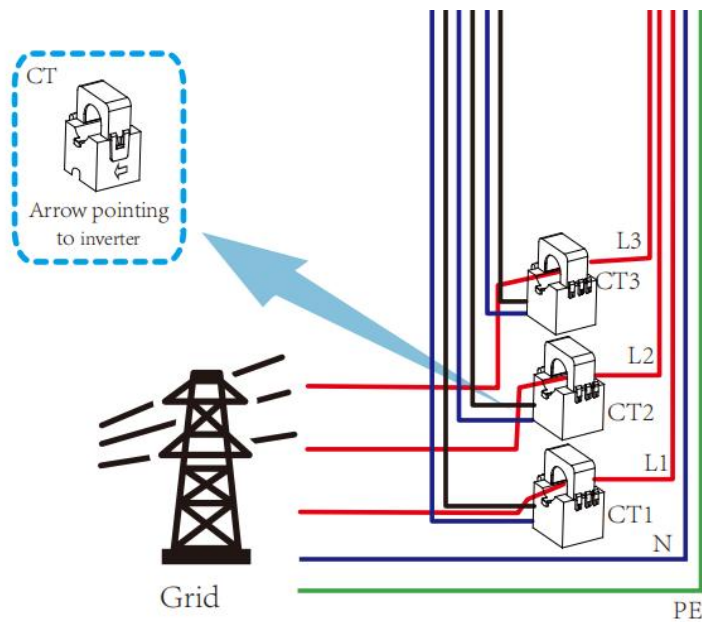

CT hookup

- (3) The AC three-phase four-wire wire harness of uninterrupted load (Backup Load) and load (Home Load) are connected to the fixed position of the corresponding port of the system; the ground wire access to the system grounding row (XT 4);

	20KW/50KWH High-voltage Optical Storage Integrated System Operator manual	filename	202310611
		Authorizat ion date	2023-09-28
		Document ation Edition	V1.0
		p a g e n u m b e r	12Page 1 of 19 pages28

(4) Install the AC side small end plate;

Pay attention to the phase sequence to prevent the error alarm of PC or equipment; use a multimeter to test the grid voltage to ensure that the grid voltage is not greater than the upper voltage limit of the national grid standard;

5.2 PV side installation

(1) Check and ensure that the PV knob switch is placed in the "OFF" position;

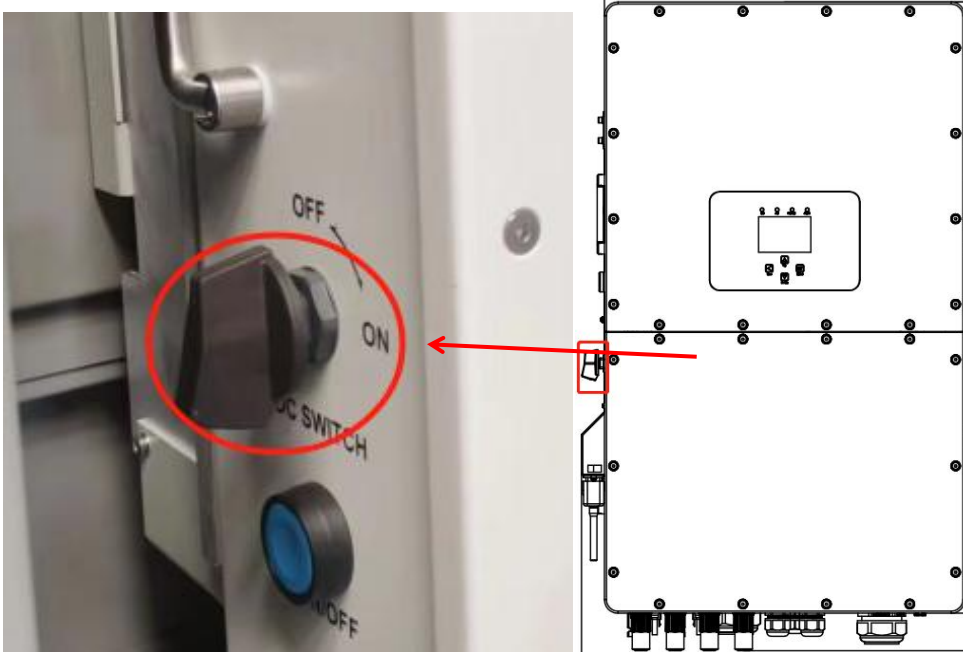

PV side switch (OFF open, ON closed)

(2) MC4 connector and cable provided in the attachment are reliably as required;

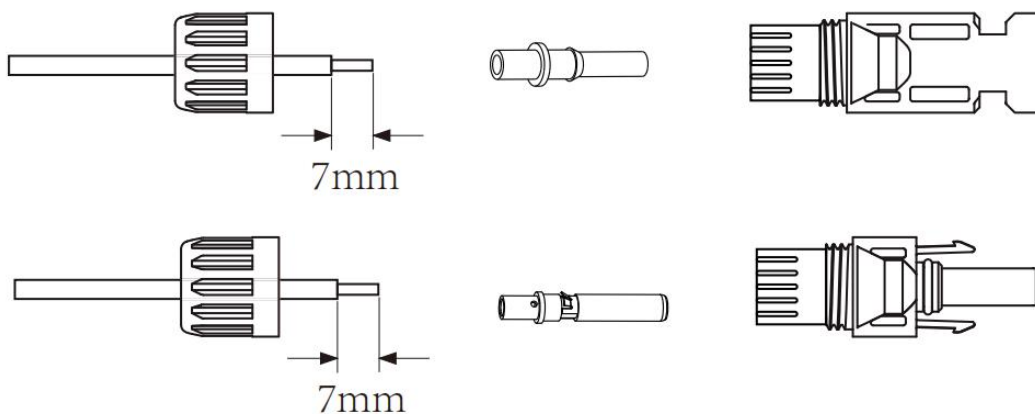

Schematic diagram of PV side connector (black) and cable installation

(3) Use the multimeter to measure the PV side voltage, check whether the polarity is correct, and ensure that the

	20KW/50KWH High-voltage Optical Storage Integrated System Operator manual	filename	202310611
		Authorizat ion date	2023-09-28
		Document Edition	V1.0
		p a g e n u m b e r	13Page 1 of 19 pages28

open-circuit voltage does not exceed 1000V;

- (4) Ensure that the maximum current of PV side single-circuit photovoltaic solar energy is 13A;
- (5) Ensure that each PV side is 11KW;
- (6) Insert the PV positive and negative connectors into the corresponding connector of the system;



5.3 WiFi data collector installation

5.3.1 Firmware installation

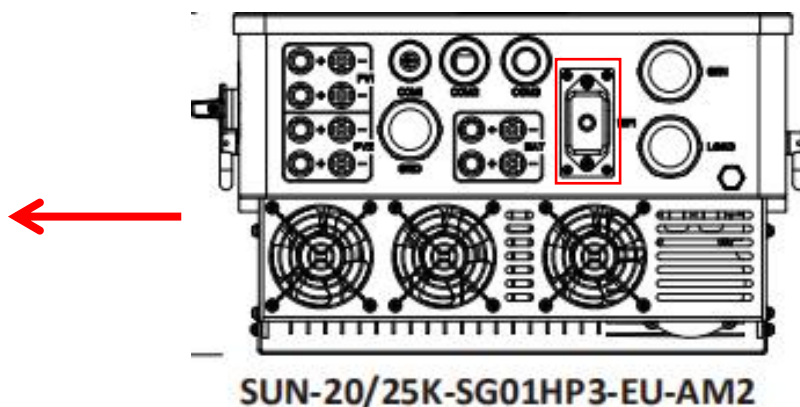

Installation location diagram

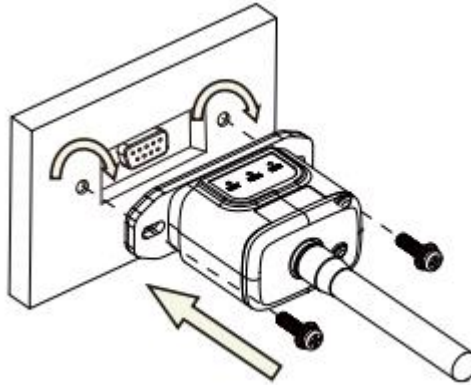

5.3.2 Data collector is installed and fixed

	20KW/50KWH High-voltage Optical Storage Integrated System Operator manual	filename	202310611
		Authorizat ion date	2023-09-28
		Document Edition	V1.0
		p a g e n u m b e r	14Page 1 of 19 pages28



Schematic diagram of installation

5.3.3 Description of the indicator light

Lights	Implication	Status Description(All lights are single green lights.)
	Communication with router	1.Light off: Connection to the router failed. 2.On 1s/Off 1s(Slow flash): Connection to the router succeeded. 3.Light keeps on: Connection to the server succeeded. 4.On 100ms/Off 100ms(Fast flash): Distributing network fast.
	Communication with inverter	1.Light keeps on: Logger connected to the inverter. 2.Light off: Connection to the inverter failed. 3.On 1s/Off 1s(Slow flash): Communicating with inverter.
	Logger running status	1.Light off: Running abnormally. 2.On 1s/Off 1s (Slow flash): Running normally. 3.On 100ms/Off 100ms(Fast flash): Restore factory settings.

indicator light description table

5.3.4WIFI Network configuration

See the attachment-WiFi network configuration;

6 . Switch and switch machine operation

6.1 Boot

6.1.1 Check before startup

After completing the maintenance or overhaul, the system needs to be started on operation. Please check the following items to ensure none before starting operation mistake.

- All connections are made according to the installation manual and the circuit diagram;
- The protective cover inside the equipment has been firmly installed;

	20KW/50KWH High-voltage Optical Storage Integrated System Operator manual	filename	202310611
		Authorizat ion date	2023-09-28
		Document Edition	V1.0
		p a g e n u m b e r	15Page 1 of 19 pages28

- The emergency stop button is released;
- Check to ensure that the DC side circuit breaker (QF 0) is disconnected;
- Check to make sure that the PV knob switch is in an off-connected state;
- Check to ensure that both the AC end switch and the leakage protection circuit breaker are disconnected;
- Check to ensure that the AC end is open and disconnected;
- Check to ensure the normal power grid and load;

警告

For the system equipment with a long downtime, a comprehensive and meticulous inspection must be made before the startup to ensure all items

6.2 Starting operation process of high voltage optical storage system

6.2.1 Boot-up sequence

Boon sequence (priority): DC side AC side PV side power;

Boon sequence (alternative): AC side DC side power PV side power;



Battery pack DC side switch (K1 AC switch on high voltage box)

Introduction of the DC side switch function:

- S1: BMS 24V Power supply switch (start-up battery)
- S2: BMS 24V power supply switch (AC / DC 1 switch power supply)
- K1: AC / DC 1 switch power supply AC switch

	<p>20KW/50KWH High-voltage Optical Storage Integrated System Operator manual</p>	filename	202310611
		Authorizat ion date	2023-09-28
		Document ation Edition	V1.0
		p a g e n u m b e r	16Page 1 of 19 pages28



AC side switch

Introduction of the AC-side switch function:

- K2: Fire protection system AC / DC2 switch power supply AC switch
- K3: Adapter AC switch (start up battery recharge)
- K4: K2 and K3 upper primary switches (A phase AC)
- K5: Emergency stop switch and 1 # AC / AC 1 switch power supply (B phase AC)
- K6: Fan switch (C phase AC)
- K7: lamp belt and, lamp board DC switch
- Backup Load: uninterrupted load port circuit breaker
- Grid: PCS grid side port circuit breaker
- Backup Load-RCD: uninterrupted load port leakage protection circuit breaker
- Home Load-RCD: load port leakage protection circuit breaker
- Grid Main Swith: Power grid side main switch

6.2.2 DC side power (high voltage battery pack)

- (1) First close the S1 switch of the battery pack, BMS power on the operation indicator light (green), wait for 3-5S, fault indicator light (red), proceed to the next step;

	20KW/50KWH High-voltage Optical Storage Integrated System Operator manual	filename	202310611
		Authorizat ion date	2023-09-28
		Document ation Edition	V1.0
		p a g e n u m b e r	17Page 1 of 19 pages28

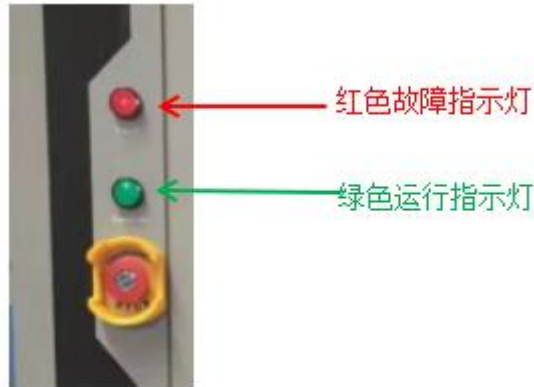

Operation, fault indicator diagram

- (2) Closed battery pack QF 0 main circuit breaker (Main Circuit Breaker), by the right side clockwise rotation 90° , make the direction of the handle for the vertical direction, and white triangle arrow pointed above, delay 3S check fault indicator is out, running indicator often on, if normal can perform the next step, if the red fault indicator is often on (abnormal), need to connect the BMS machine for fault search;



disconnect state

Closed state

- (3) Close the K1 and S2 switches of the battery pack;

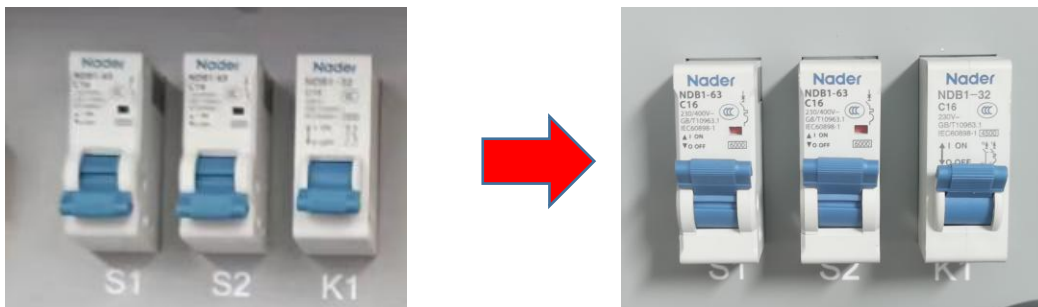

S1 / S2 / K1 switch (button down "OFF" state) S1 / S2 / K1 switch (button up "ON" state)

- (4) Close the blue button of the light storage hybrid inverter (ON / OFF below), the battery pack on the DC side will

	20KW/50KWH High-voltage Optical Storage Integrated System Operator manual	filename	202310611
		Authorizat ion date	2023-09-28
		Document Edition	V1.0
		p a g e n u m b e r	18Page 1 of 19 pages28

power on the PCS, the PCS display will be lit, and the PCS will conduct self-check, at this time, there is no power on the AC side, the PCS will alarm (no voltage at the grid end), the fault will be automatically eliminated after the input of the grid;

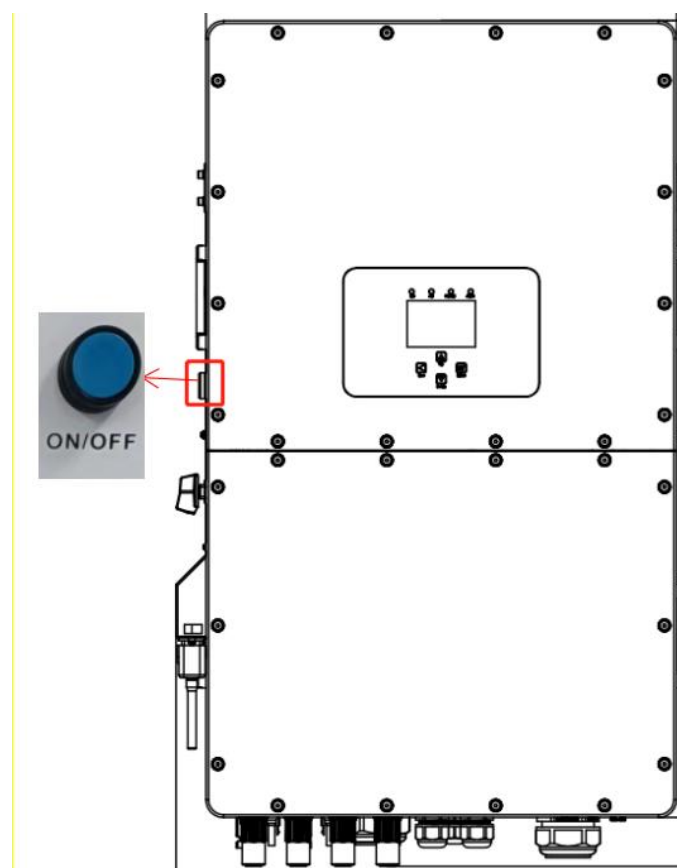

Switch diagram on DC side (ON: Press OFF: Parallel)

6.2.3, AC side power on

- (1) Close the main switch into the power grid, the mains configuration requirements are three phases and five lines, pay attention to the phase sequence, to prevent PCS due to the phase order error alarm;
- (2) Close the system power grid main switch (GRID-Main Switch);

	20KW/50KWH High-voltage Optical Storage Integrated System Operator manual	filename	202310611
		Authorizat ion date	2023-09-28
		Document Edition	V1.0
		p a g e n u m b e r	19Page 1 of 19 pages28



Main switch (driven from bottom to top)

- (3) After the delay of 30S, after the PCS self-test, close the system uninterrupted load and load leakage protection circuit breaker (Backup Load, Home Load); if the uninterrupted load or load port is not used, please disconnect the relevant leakage protection circuit breaker to ensure safety;



Unstop load and load leakage protection circuit breaker (driven from bottom up)

- (4) Close the system K2-K7 switch, AC side power to complete;

	20KW/50KWH High-voltage Optical Storage Integrated System Operator manual	filename	202310611
		Authorizat ion date	2023-09-28
		Document ation Edition	V1.0
		p a g e n u m b e r	20Page 1 of 19 pages28



System single-phase AC switch (driven from bottom to top)

6.2.4 PV side power-on

- (1) PV knob switch to "ON" position;



The whole system power supply is completed;

⚠ 危险

There is high voltage in the equipment, accidental touch may cause fatal shock hazard, so during live measurement shall:

Do a good job of protection (such as wearing insulating gloves, etc.).

There must be escorts to ensure personal safety.

6.3 The PCS operation

6.3.1 Battery Switch

The PCS is properly installed, and the battery is well connected, just by pressing the ON / OFF button (on the left side of the enclosure). When the PCS is not connected to the battery pack, but connected to the PV and the grid, and

	20KW/50KWH High-voltage Optical Storage Integrated System Operator manual	filename	202310611
		Authorization date	2023-09-28
		Document Edition	V1.0
		page number	21Page 1 of 19 pages28

the ON / OFF button is turned off, the LCD will still light up (the monitor displays the OFF). In this case, the system will still work when the ON / OFF button is turned on and the NO Battery button will be selected;

6.3.2 Operation and reality panels

The operation and display panels shown in the following figure are on the front panel of the PCS.

It includes four indicator lights, four function keys and an LCD display to indicate operation status and input / output power information.



PCS LED indicator light		
LED pilot lamp		meaning
DC	Green LED indicator light	The PV connection was normal
AC	Green LED indicator light	The grid connection is normal
Normal	Green LED indicator light	PCS in working order
Alarm	Red LED indicator light	Fault or warning
PCS function button		
function key	description	
ESC	Exit Setup Mode	
UP	Go to the previous selection	
Down	Go to the next option	
Enter	To confirm the choice	

6.4 PCS LCD screen icon

6.4.1 Main Screen

The LCD is a touch screen, with the overall PCS information displayed below the screen.

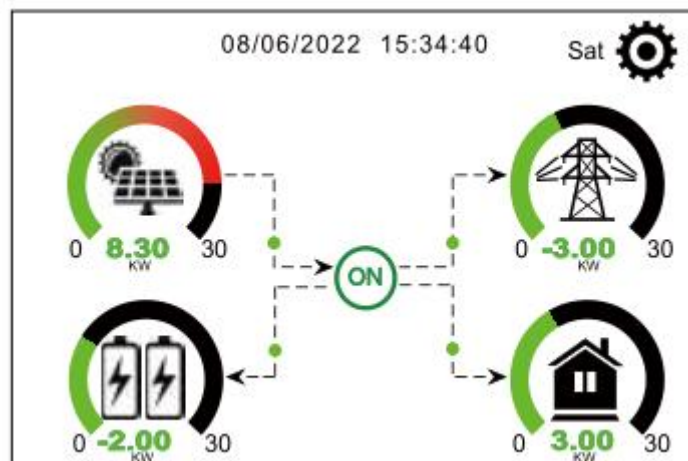

- (1) The icon in the center of the home screen indicates the normal operating status of the system processing."ON"

	20KW/50KWH High-voltage Optical Storage Integrated System Operator manual	filename	202310611
		Authorization date	2023-09-28
		Document Edition	V1.0
		page number	22Page 1 of 19 pages28

represents PCS running normally if " com./ F01~F64 ", which means that there are communication errors or other errors in the PCS, and the error message will be displayed under this icon (F01~F64 error, detailed error information can be viewed in the system alert menu);

- (2) Time is shown at the top of the screen;
- (3) System Settings icon (upper right corner of the main screen, "Sat"), press this setting button, you can enter the system Settings screen, including basic Settings, battery Settings, grid Settings, system working mode, generator port use (this port is not connected), advanced functions and equipment information;
- (4) The main screen displays information including solar energy, power grid, loads and batteries. It shows the direction of the energy flow through an arrow. When the power supply approaches the high level, the color on the panel will change from green to red, so that the system information will be vividly displayed on the home screen.
- (5) The PV power is always positive, click the PV icon:

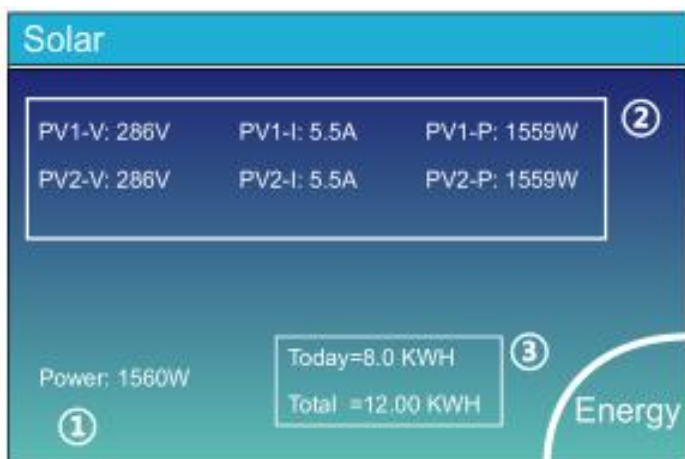

This is the details page for the solar panels:

- ① Solar panels currently generate total power
- ② Voltage, current, and power for each MPPT
- ③ Daily photovoltaic power generation and total power generation

Pressing the "Energy" button will enter the power curve interface

- (6) "Negative" grid power means selling to the grid, "positive" means getting from the grid; click the grid icon:



This is the power grid details page:

- ① State, power, and frequency;
- ② L: Voltage per phase;
CT: Power detected by the external current sensor;
LD: Power detected using the internal sensor on the AC grid input / output breaker;
- ③ BUY: Energy from the power grid to the inverter;
SELL: Energy from inverter to power grid;

- (7) Battery power is "negative" for charge and "positive" for discharge; click the battery icon:

	20KW/50KWH High-voltage Optical Storage Integrated System Operator manual	filename	202310611
		Authorization date	2023-09-28
		Document Edition	V1.0
		page number	23Page 1 of 19 pages28

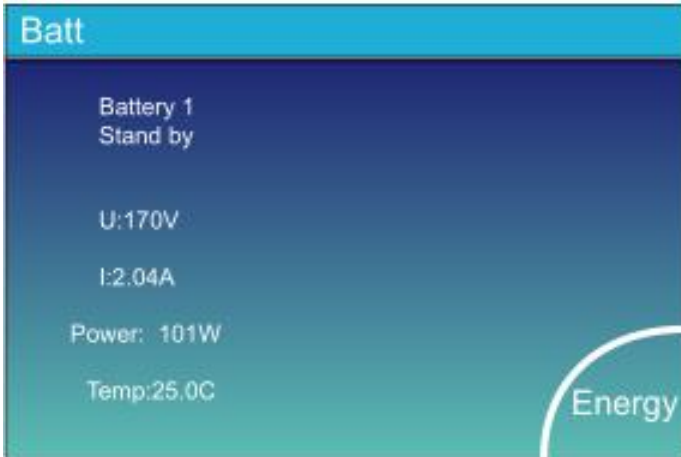

This is the battery details page:

- ① Number of battery clusters;
- ② Battery cluster status, charging, discharge, standby, etc.;
- ③ Battery cluster voltage, current, power, and temperature

Pressing the "Energy" button will enter the battery cluster details interface



	Volt	Curr	Temp	SOC	Energy	Charge	Fault	
1	150.3V	19.70A	30.6C	32.0%	26.6Ah	0.0V	0.0A	0000
2	150.2V	19.10A	31.0C	51.0%	25.5Ah	153.2V	25.5A	0000
3	150.1V	18.90A	30.2C	12.0%	6.0Ah	153.2V	25.5A	0000
4	0.00V	0.00A	0.0C	0.0%	0.0Ah	0.0V	0.0A	0000
5	0.00V	0.00A	0.0C	0.0%	0.0Ah	0.0V	0.0A	0000
6	0.00V	0.00A	0.0C	0.0%	0.0Ah	0.0V	0.0A	0000
7	0.00V	0.00A	0.0C	0.0%	0.0Ah	0.0V	0.0A	0000
8	0.00V	0.00A	0.0C	0.0%	0.0Ah	0.0V	0.0A	0000
9	0.00V	0.00A	0.0C	0.0%	0.0Ah	0.0V	0.0A	0000
10	0.00V	0.00A	0.0C	0.0%	0.0Ah	0.0V	0.0A	0000
11	0.00V	0.00A	0.0C	0.0%	0.0Ah	0.0V	0.0A	0000
12	0.00V	0.00A	0.0C	0.0%	0.0Ah	0.0V	0.0A	0000
13	0.00V	0.00A	0.0C	0.0%	0.0Ah	0.0V	0.0A	0000
14	0.00V	0.00A	0.0C	0.0%	0.0Ah	0.0V	0.0A	0000
15	0.00V	0.00A	0.0C	0.0%	0.0Ah	0.0V	0.0A	0000

(8) Load power is always positive, click the load icon:



This is the uninterrupted load (Back-up Load) details page:

- ① Current power of the uninterruptible power supply;
- ② Voltage and power of each phase;
- ③ Daily power consumption and total power consumption of uninterrupted load;

Pressing the "Energy" button will enter the power curve interface

(9) Run information display, click the middle "ON" icon:

 HAIDI	20KW/50KWH High-voltage Optical Storage Integrated System Operator manual	filename	202310611
		Authorization date	2023-09-28
		Document Edition	V1.0
		page number	24Page 1 of 19 pages28

1166w		1244w 50Hz		-81w 50Hz ①	
221v	0w	222v	0.8w	222v	0.1A
229v	1166w	229v	5.0w	230v	0.1A
225v	0w	229v	0.9w	223v	0.1A
		HM:	LD:	INV_P:	
Load		-10W	28W	-30W	
		5W	1192W	-26W	AC_T:
		0W	24W	-25W	38.8C
21w		Grid		Inverter	
0w	0w	0W	0W	0W	0W
150V	150V	0V	0V	0V	0V
-0.41A	-0.41A	0.0A	0.0A	0.0A	0.0A
27.0C	27.0C				
Battery		PV			

This is the PCS Run details page:

① Voltage, current and power per phase of the PCS generator port;

AC-T: average radiator temperature;

(10) Solar energy, load, power grid curve interface

	<p>20KW/50KWH High-voltage Optical Storage Integrated System Operator manual</p>	filename	202310611
		Authorizat ion date	2023-09-28
		Document ation Edition	V1.0
		p a g e n u m b e r	25Page 1 of 19 pages28

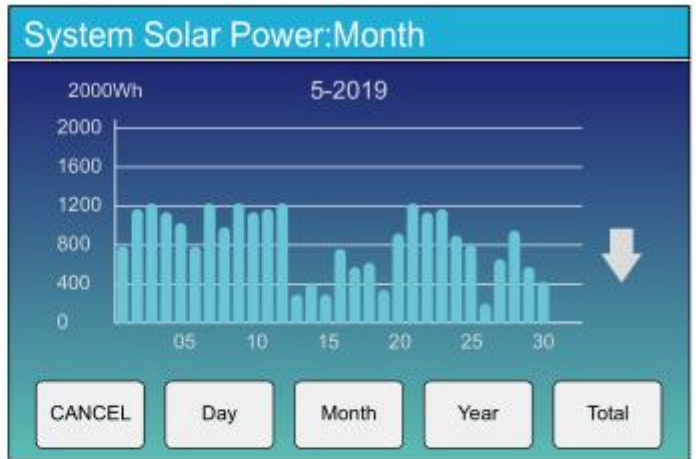
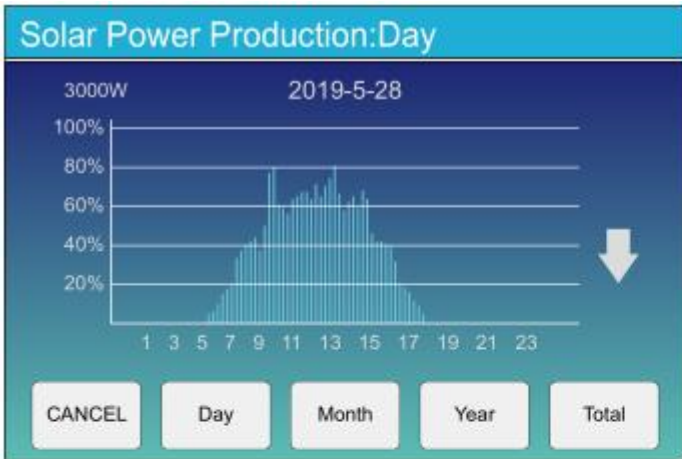

Daily, monthly, annual and total solar power curves can be roughly checked on the LCD, and to generate electricity more accurately, check on the monitoring system. Click the upper and lower arrow to view the power curve of different periods;

	20KW/50KWH High-voltage Optical Storage Integrated System Operator manual	filename	202310611
		Authorization date	2023-09-28
		Documentation Edition	V1.0
		page number	26Page 1 of 19 pages28

6.4.2 Operation flow chart of LCD

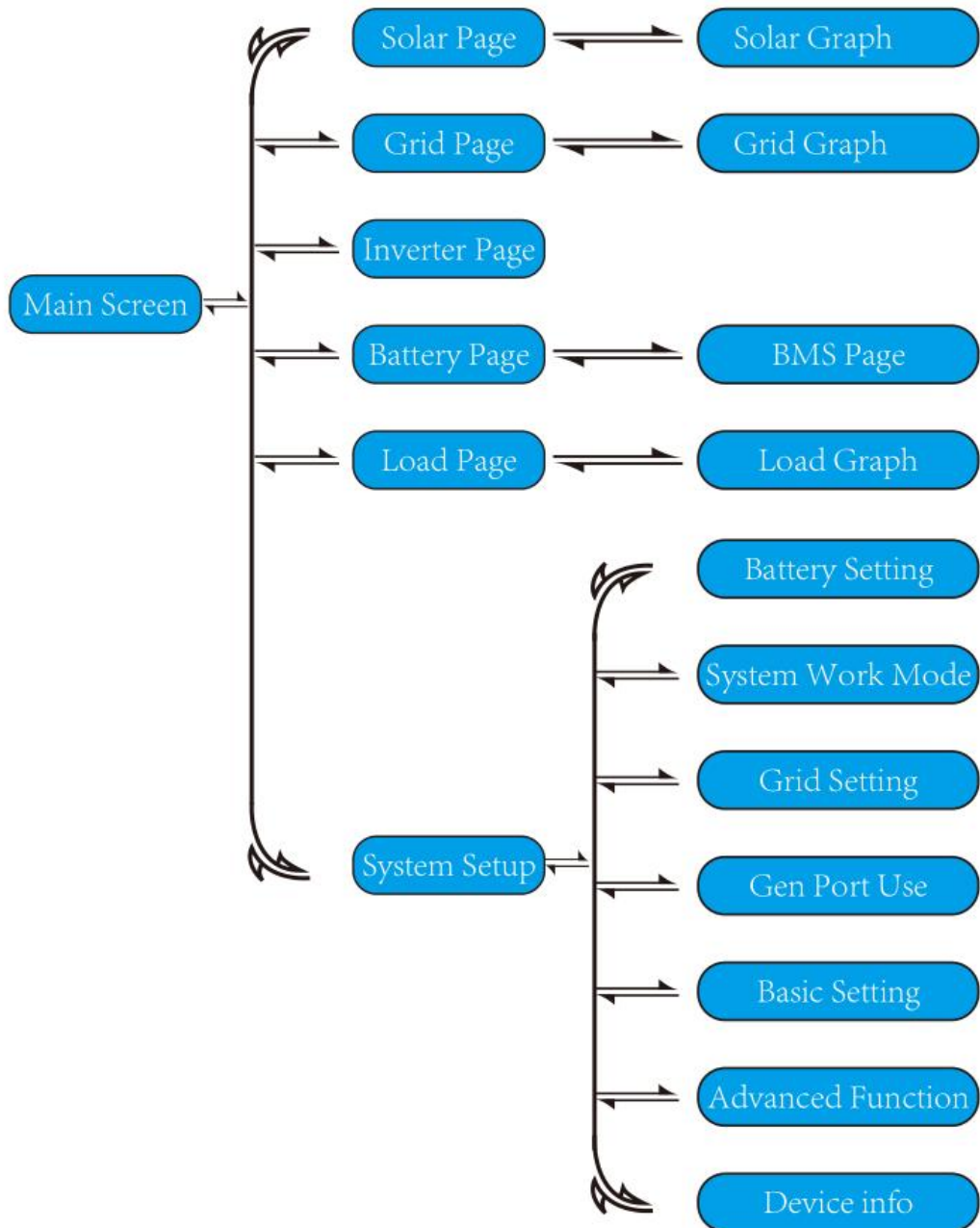

	20KW/50KWH High-voltage Optical Storage Integrated System Operator manual	filename	202310611
		Authorization date	2023-09-28
		Documentation Edition	V1.0
		page number	27Page 1 of 19 pages28

6.4.3 PCS system Setup menu

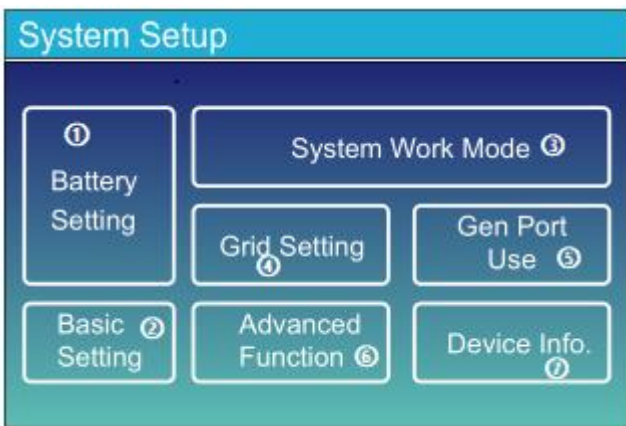

This is the PCS system setup page:

- ① Battery setting
- ② Basic Settings
- ③ System working mode
- ④ Power grid setting
- ⑤ Generator port use (this port is not connected)
- ⑥ AF
- ⑦ facility information

(1) Basic Setup Menu



Factory Reset (Factory reset): Reset all the parameters of the inverter.

Lock out all changes (Lock all changes): Enable this menu to set parameters that need to be locked and cannot be set.

To keep all changes before the factory reset and lock system, you need to type a password to enable setting.

Language Settings: Click the right-down arrow to enter the language Settings interface;

	20KW/50KWH High-voltage Optical Storage Integrated System Operator manual	filename	202310611
		Authorizat ion date	2023-09-28
		Document ation Edition	V1.0
		p a g e n u m b e r	28Page 1 of 19 pages28

(2) Battery Setup Menu

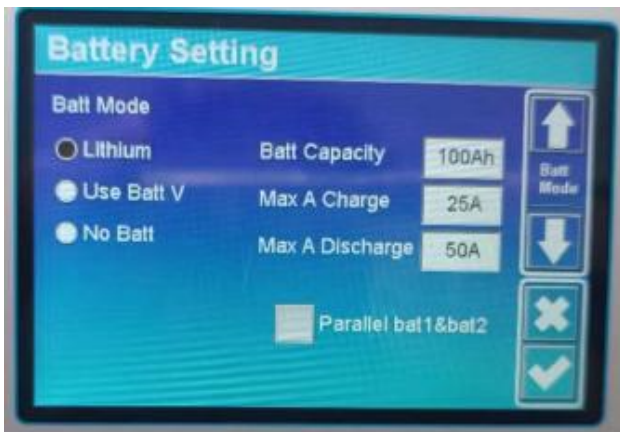

Battery capacity (Battery capacity): It displays the size of the battery pack to the Deye hybrid inverter.

Use Batt V (Using battery voltage): Battery voltage (V) is used for all settings.

Use Batt% (% battery power used): All settings use battery power SOC (%).

Max. A charge / discharge (Maximum charge / discharge current): Maximum battery charge / discharge current (25 / 50KW model 0-50A).

For lithium batteries, we recommend that the battery capacity x 50%= charge / discharge maximum current.

No Batt (No battery): If the system is not battery connected, check this item.

	20KW/50KWH integrated system for High-voltage optical storage Operator manual	filename	202310611
		Authorization date	2023-09-28
		Document Edition	V1.0
		page number	29Page 1 of 19 pages18

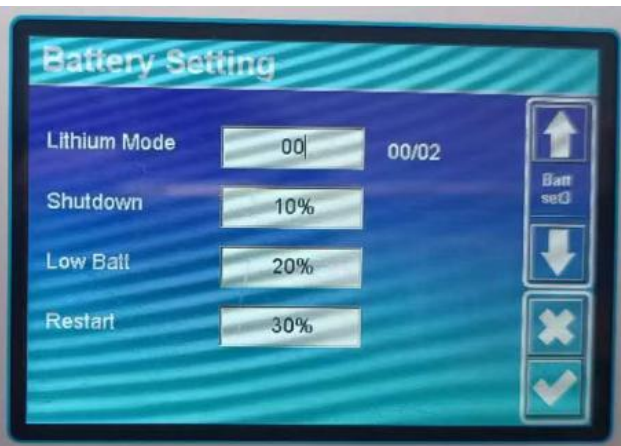

(1) System working mode

① **Generator (this is not available)**
 Start=30%: With the SOC below 30%, the PCS will start the generator to charge the battery pack;
 A=20A: charge current 20A from the generator
 Gen Charge: Use the generator to charge the connected battery pack after checking;
 Gen Signal: After checking, close the normally open relay when the generator start signal state is activated;

② **electrified wire netting**
 Start=30%: When the SOC is below 30%, the PCS will start the grid (grid connection) to charge the battery pack;
 A=37A: 37A charging current from the grid
 Grid Charge: After checking, use the power grid (grid-connected) to charge the connected battery pack;
Grid Signal: Power grid signal

Lithium Mode (Lithium battery mode): This is the BMS protocol. Refer to the documentation (approved battery)
 Shutdown 10% (10%): if the battery SOC is below this value, PCS will stop;
 Low Batt 20% (low battery power of 20%): It means that if the



work pattern
 Selling First (Sales first): This mode allows the hybrid inverters to sell any excess power generated by the solar panels back to the grid. Battery energy can also be sold to the grid if effective.
 Photovoltaic energy will be used to power the load and charge the batteries, and then the excess energy will flow to the grid.
 The load power supply priority is as follows:
 1. solar panel

	20KW/50KWH integrated system for High-voltage optical storage Operator manual	filename	202310611
		Authorizat ion date	2023-09-28
		Document Edition	V1.0
		p a g e n u m b e r	30Page 1 of 19 pages18

Zero Export To Load (Zero output to load): The hybrid inverter will only power the connected backup load. Hybrid inverters neither provide power to the home load nor sell power to the grid. The built-in CT will detect the power flowing back to the grid and will reduce the power of the inverter, supplying only the local load and charging the battery.

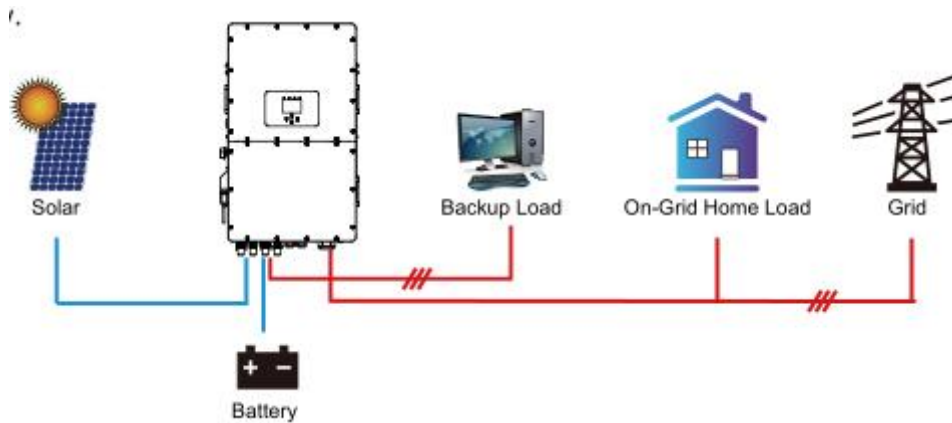

Zero Export To CT (Zero output to CT): The hybrid inverter supplies not only powers the connected backup load, but also the connected home load. If the photovoltaic power and battery power are insufficient, the grid will be supplemented by the energy. Hybrid inverters do not sell power to the grid. In this mode, a CT is required. Refer to Chapter 5.1 AC side Installation for the CT installation method. The external CT will detect the power flowing back to the grid and will reduce the power of the inverter to power only the local loads and charge the battery and home loads.

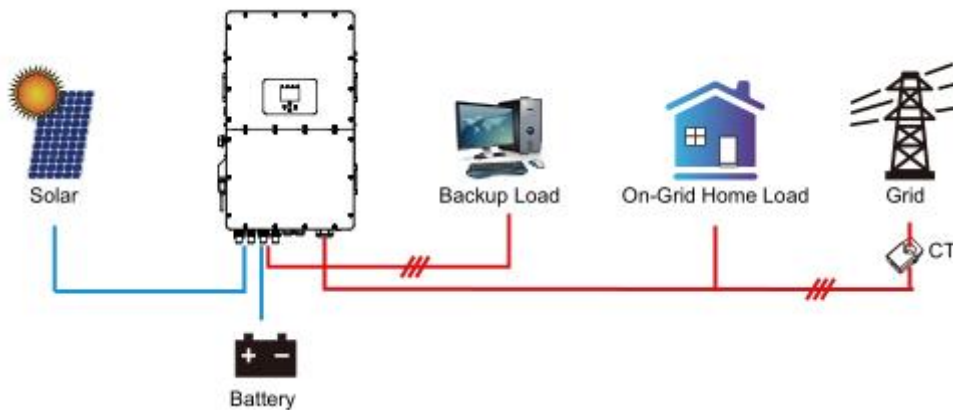

Solar Sell (Solar energy sales): refers to zero to load or zero to CT: when the project is active, excess energy can be sold back to the grid. When it is active, the priority of photovoltaic power is as follows: load consumption and charging the battery and connecting to the grid.

Max.sell power (Maximum output power): allow the maximum output power to flow to the grid

Zero-export Power (Zero output power): For the zero output mode, it tells the grid to output power. It is recommended to set it to 20-100W to ensure that the hybrid inverter does not supply power to the grid.

	20KW/50KWH integrated system for High-voltage optical storage Operator manual	filename	202310611
		Authorizat ion date	2023-09-28
		Document Edition	V1.0
		p a g e n u m b e r	31Page 1 of 19 pages18

Energy Pattern (Energy mode): photovoltaic power supply is preferred.

Batt First (Battery first): Photovoltaic power generation is first used to charge the battery, and then used to power the load. If the photovoltaic power is insufficient, the grid will replenish both the battery and the load.

Load First (Load-first): Photovoltaic power is first used to power the load, and then used to charge the battery. If the photovoltaic power is insufficient, the grid will supply the power to the load.

Max Solar Power (Maximum solar power): the maximum DC input power is allowed.

Grid Peak-shaving (Grid peak regulation): When it is active, the grid output power will be limited to the set value. If the load power exceeds the allowable value, the photovoltaic energy and battery will be supplemented. If the load requirements are still not met, the grid power will be increased to meet the load requirements.

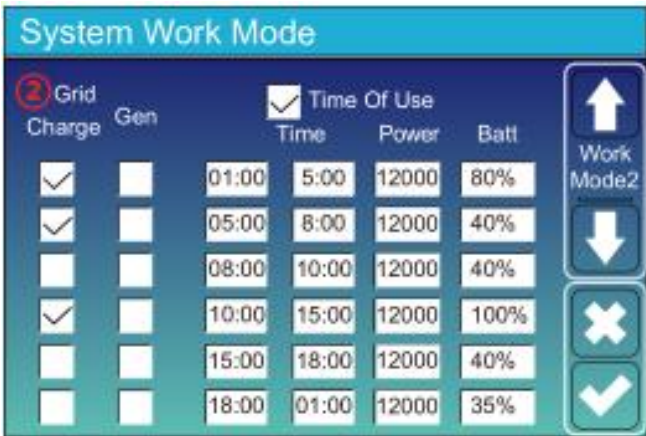

Time of use (Use time): used to program when to charge the battery with the grid or generator, and when to discharge the battery to power the load. Just check "Use Time" and the following items (grid, charging, time, power, etc.) will take effect.

Note: When the battery can be sold to the grid

Gen charge (Generator charging): Use a diesel generator to charge the battery for a period of time

Time: Range is 01:00,24:00.

Note: When there is a grid, just check "use time" and the battery will discharge. Otherwise, the battery will not discharge even if the battery SOC is full. But in off-grid mode (when the grid is not available, the inverter will automatically work in off-grid mode).

Power (Power): the maximum allowable discharge power of the battery.

Batt (SOC%): Battery SOC% when the action occurs.

for instance:

During the period of 01:00–05:00

If the battery SOC is below 80%, it will use the grid to charge the battery until the battery SOC reaches 80%.

During the period of 05:00–08:00

If the battery SOC is above 40%, the hybrid inverter will discharge the battery until the SOC reaches 40%. At the same time, if the battery SOC is less than 40%, then the grid will charge the battery SOC to 40%;

During the period of 08:00–10:00

If the battery SOC is above 40%, the hybrid inverter will discharge the battery until the SOC reaches 40%.

During 10:00–15:00

When the battery SOC is below 100%, the hybrid inverter will charge the battery until the SOC reaches 100%;

During 15:00–18:00

When the battery SOC is above 40%, the hybrid inverter will discharge the battery until the SOC reaches 40%.

During the period of 18:00–01:00

When the battery SOC is above 35%, the hybrid inverter will discharge the battery until the SOC reaches 35%.

(2) Grid Setup Menu

	20KW/50KWH integrated system for High-voltage optical storage Operator manual	filename	202310611
		Authorization date	2023-09-28
		Document Edition	V1.0
		page number	32Page 1 of 19 pages18

Grid Setting/Grid code selection

Grid Mode: 0/10

Grid Frequency: 50HZ 60HZ

Phase Type: 0/120/240 0/240/120

Grid Level:

IT system-neutral is not grounded

Grid Set1 (down arrow), Grid Set2 (up arrow), Cancel (X), Confirm (checkmark)

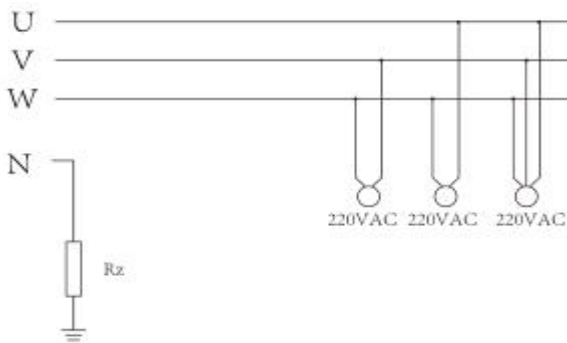

Grid Mode (Grid Mode): General Standards, UL1741 and IEEE1547, CPUC RULE21, SRD-UL-1741, CEI 0-21, Australia A, Australia B, Australia C, EN50549 _ CZ-PPDS (> 16A), New Zealand, VDE4105, OVE Directive R25.

Please follow the local grid specification and then select the appropriate grid standard.

Grid level (Grid grade): When the inverter is in off-grid mode, its output voltage has several voltage levels.

IT system: For the IT power grid system, the line voltage (between any two lines in the three-phase circuit) is 230 Vac, and the schematic diagram is as follows. If your grid system is an IT system, enable the IT System and check the Grid Level as

Rz: the large resistance grounding resistor or the system has no neutral wire.

Grid Setting/Connect

Normal connect Normal Ramp rate:

Low frequency: High frequency:

Low voltage: High voltage:

Reconnect after trip Reconnect Ramp rate:

Low frequency: High frequency:

Low voltage: High voltage:

Reconnection Time: PF:

Grid Set2 (up arrow), Grid Set1 (down arrow), Cancel (X), Confirm (checkmark)

Normal connect (Normal connection): the allowable grid voltage / frequency range when the inverter is first connected to the grid.

Reconnect after trip (Reconnect after trip): After the inverter trips from the power grid, the inverter allows the power grid voltage / frequency range of the inverter to connect to the power grid

Reconnection time (Reconnection time): Wait time for the inverter to reconnect to the power grid

PF: Power factor used for adjusting the reactive power of the inverter

	20KW/50KWH integrated system for High-voltage optical storage Operator manual	filename	202310611
		Authorizat ion date	2023-09-28
		Document Edition	V1.0
		p a g e n u m b e r	33Page 1 of 19 pages18

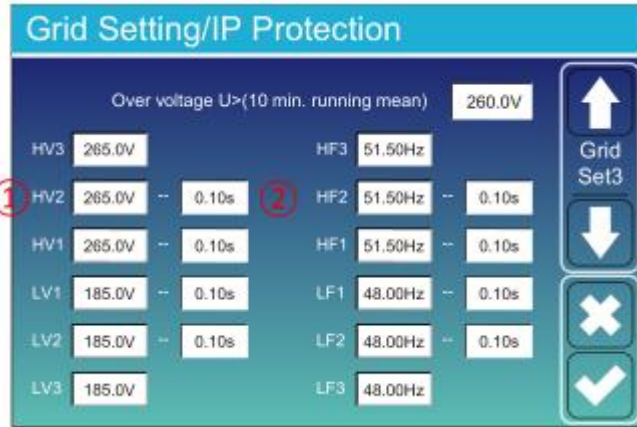

① HV 1: Level 1 overvoltage protection point ② 0.10S: Trip time
 HV 2: Level 2 overvoltage protection point
 HV 3: Level 3 overvoltage protection point
 LV1: Level 1 undervoltage protection point
 LV 2: Level 2 undervoltage protection point
 LV 3: Level 3 underpressure protection point
 HF 1: Level 1 overfrequency protection point
 HF 2: Level 2 overfrequency protection point
 HF 3: Level 3 overfrequency protection point
 LF 1: Level 1 low-frequency protection point
 LF 2: Level 2 low-frequency protection point



FW: This series of inverters can adjust the output power of the inverter according to the grid frequency.
 Droop F:% of the nominal power per Hz. For example, when the grid frequency reaches 50. At 2Hz, "Start frequency F>50.2Hz, stop frequency F <51.5, Droop F =40%P / Hz", the inverter will reduce the active power by 40% at the Droop frequency. Then, when the grid system frequency is below 50.1Hz, the inverter will stop reducing the output power.
 For detailed settings, follow the local grid code.

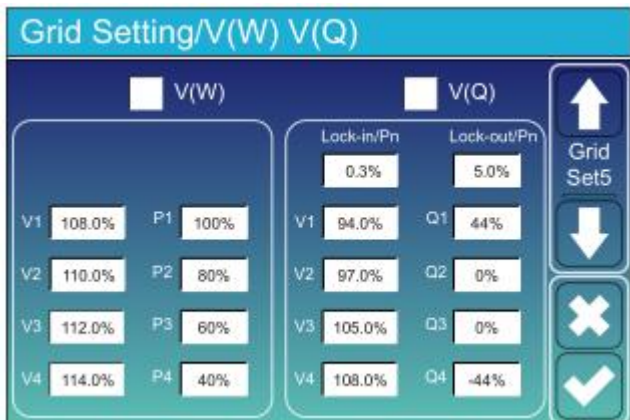

VW: It is used to adjust the active power of the inverter according to the set power grid voltage.
 V (Q): used to adjust the inverter according to the set grid voltage.
 This function is used to adjust the inverter output power (active power and reactive power) when the grid voltage changes.
 For example: V2=110%, P2=80%. When the grid voltage reaches 110% of the rated grid voltage, the output power of the inverter reduces the active output power to 80% of the rated power.

	20KW/50KWH integrated system for High-voltage optical storage Operator manual	filename	202310611
		Authorizat ion date	2023-09-28
		Document Edition	V1.0
		p a g e n u m b e r	34Page 1 of 19 pages18

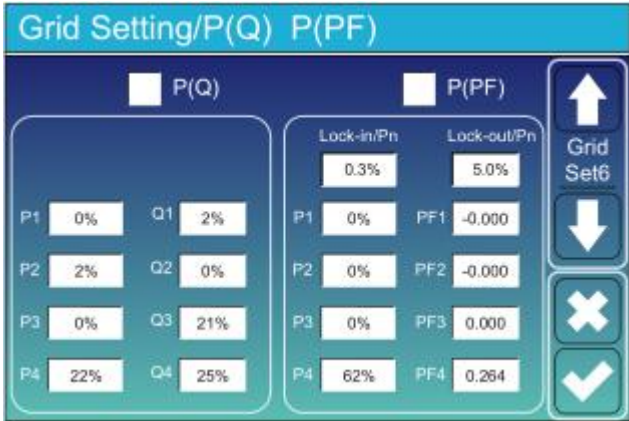

P (Q): Adjust the inverter reactive power according to the set active power.
 P (PF): Adjust the inverter PF according to the set active power.
 For detailed settings, follow the local grid code.

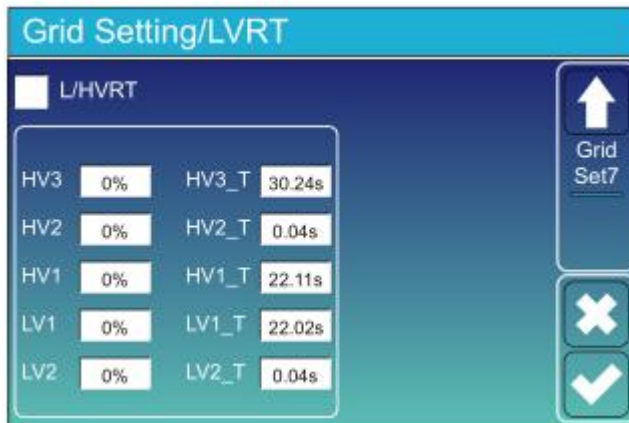

Reserved (Retention): This feature is reserved. It is not recommended.

(3) The generator port uses the settings menu

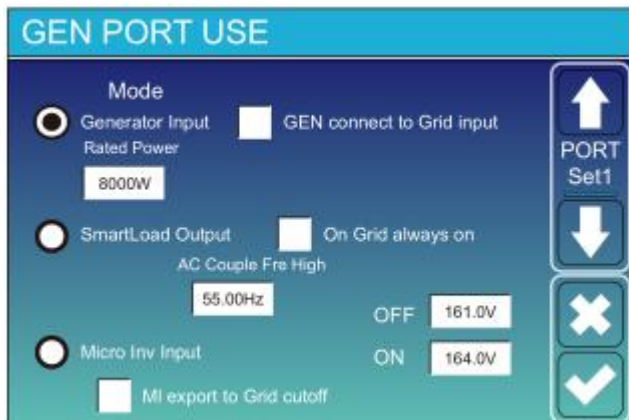

Generator input rated power (Generator input rated power): the maximum allowable power of the diesel generator.
GEN connect to grid input (Generator connection to the grid input): Connect the diesel generator to the grid input port
 Smart Load Output: (Intelligent load output): This mode uses the generator input connection as the output and only receives power when the battery SOC and PV power is above the user programmable threshold.

	20KW/50KWH integrated system for High-voltage optical storage Operator manual	filename	202310611
		Authorization date	2023-09-28
		Document Edition	V1.0
		page number	35Page 1 of 19 pages18

e.g. ON: 100%, OFF: 95% (e. g. ON: 100%, OFF: 95%): When the PV power exceeds 500W and the battery pack SOC reaches 100%, the smart load port will automatically open and power the connected load. The smart load port will automatically close when the battery pack SOC is <95%.

Smart Load OFF Batt (Smart load close battery): Smart load will close the battery SOC.

Smart Load ON Batt (Smart load-on battery): The smart load will be connected to the battery SOC at the same time, and then the smart load will be connected.

On Grid always on (Always on): When "Always on" is clicked, the smart load will be turned on when the grid exists.

Micro Inv Input: (Inverter input): The generator input port should be used as the input of the micro inverter (AC coupling), and this function is also applicable to the "grid-connected" inverter.

Micro Inv Input OFF: When the battery SOC exceeds the set value, the Microinverter or grid-connected inverter will be closed.

Micro Inv Input ON: When the battery SOC is below the set value, the Microinverter or grid-connected inverter will start.

AC Couple Fre High: If "Micro Inv input" is selected, the output power of the micro-inverter will decrease linearly as the battery SOC gradually reaches the set value (OFF). When the battery SOC is equal to the set value (OFF), the system frequency will change to the set value (high AC coupling frequency) and the micro inverter will stop working. MI export to the grid cutoff: stop exporting the power generated by the micro inverter to the grid.

Note: Micro Inv Input OFF and On are the only available for some FW versions.

(4) The Advanced Features Settings menu

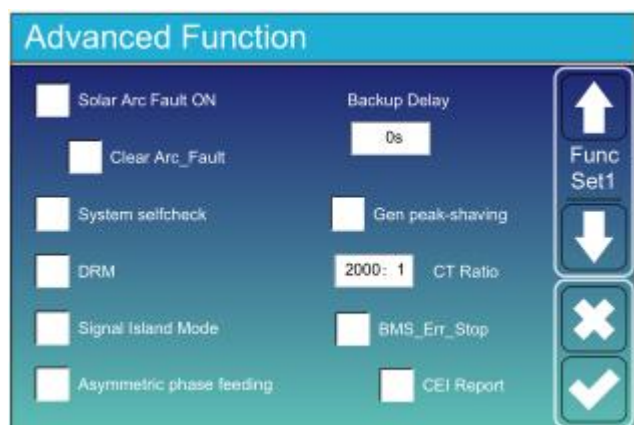

Solar Arc Fault ON (Solar arc failure turned on): This only applies to the United States.

System selfcheck (System self-test): disabled. This only applies to factories.

Gen Peak-shaving (Generator peaking): enabled When the power of the generator exceeds its rating, the inverter will provide redundant components to ensure that the generator does not overload.

DRM: It is applicable to the AS4777 standard

Signal island mode (Signal island mode): If "Signal island mode" is selected and the inverter is in off-grid mode, the relay on the neutral line (load port N line) will be connected, and then the N line (load end N line) will be connected to the inverter ground.

	20KW/50KWH integrated system for High-voltage optical storage Operator manual	filename	202310611
		Authorization date	2023-09-28
		Document Edition	V1.0
		page number	36Page 1 of 19 pages18

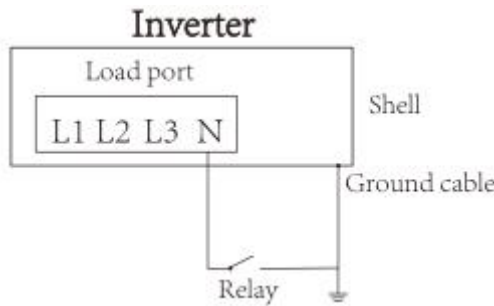

Asymmetric phase feeding (Asymmetric phase feeding): The power fed by the photovoltaic inverter to the grid will be balanced.



Ex_Meter For CT (Ex _ Meter for CT): When using zero output to CT mode, the hybrid inverter can select the Ex _ Meter function for CT and use a different meter. For example, the CHNT and the Eastron.

(5) The Device Information Settings menu



This page displays the converter ID, converter versions and alarm code.
 HMI: The LCD version
 MAIN: control board firmware version

6.5 APP operation

The APP and platform use manual are detailed in the SOLARHUB APP Operation Manual and the SOLARHUB Smart

	20KW/50KWH integrated system for High-voltage optical storage Operator manual	filename	202310611
		Authorization date	2023-09-28
		Document Edition	V1.0
		page number	37Page 1 of 19 pages18

Energy Digital Management Platform-English version.

6.6 Shutdown

Shutdown is usually divided into normal maintenance or maintenance shutdown and failure or crisis shutdown two situations. Where required, perform the shutdown operation as described in this section. Single or multiple cluster parallel using the battery cluster under the shutdown of this shutdown operation;

6.6.1 Normal shutdown

6.2.1.1 Power-off sequence

(Pest) PCS display operation standby off PV side switch disconnected AC side switch DC side switch;

(Alternative) PCS display operation standby disconnect DC side switch disconnect PV side switch disconnect AC side switch;

(1) PCS display operating standby

Set the battery SOC to the actual SOC of the current battery, until the inverter is in standby state for the next step;

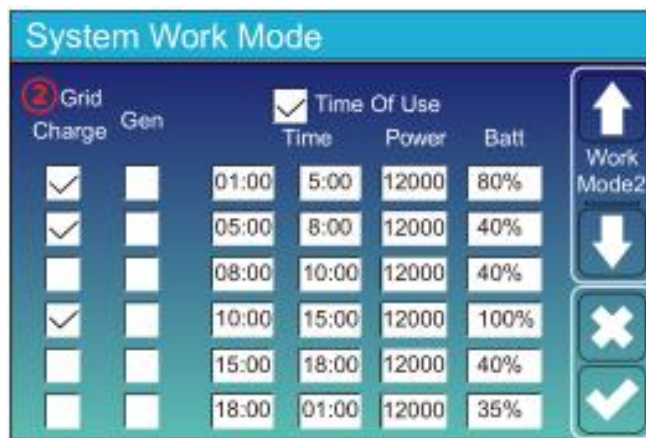

(2) Disconnect the photovoltaic rotation control switch;

	20KW/50KWH integrated system for High-voltage optical storage Operator manual	filename	202310611
		Authorization date	2023-09-28
		Document Edition	V1.0
		page number	38Page 1 of 19 pages18



PV rotation control switch (rotation from ON to OFF)

(3) Disconnect the main power grid switch on the AC side of the system;



Circuit breaker (button down OFF, button up ON)

(4) Disconnect the K2 to K7 switch on the AC side;

	20KW/50KWH integrated system for High-voltage optical storage Operator manual	filename	202310611
		Authorizat ion date	2023-09-28
		Document ation Edition	V1.0
		p a g e n u m b e r	39Page 1 of 19 pages18



K2-K7 switch (button down OFF, button up ON)

(5) Disconnect the AC side uninterrupted load and the power grid circuit breaker;



Circuit breaker (button down OFF, button up ON)

(6) Disconnect the battery switch on the PCS;



Battery switch (press ON, parallel OFF)

(7) Disconnect the battery voltage box S1, S2 and K1;

	20KW/50KWH integrated system for High-voltage optical storage Operator manual	filename	202310611
		Authorizat ion date	2023-09-28
		Document ation Edition	V1.0
		p a g e n u m b e r	40Page 1 of 19 pages18

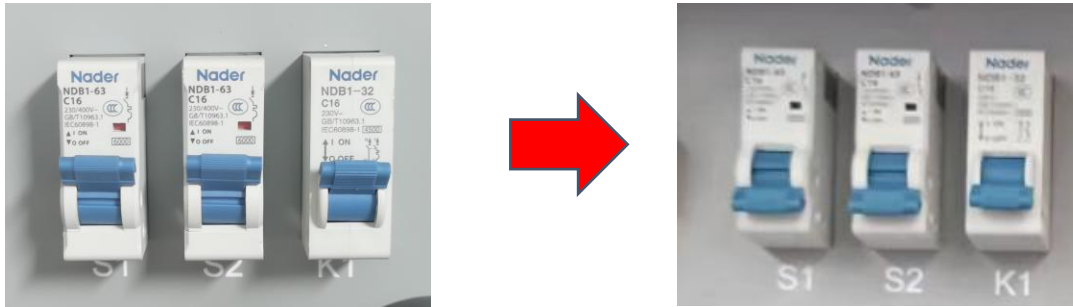

HP box panel control switch (button down OFF, button up ON)

(8) Disconnect the battery pack main switch (QF 0) circuit breaker;

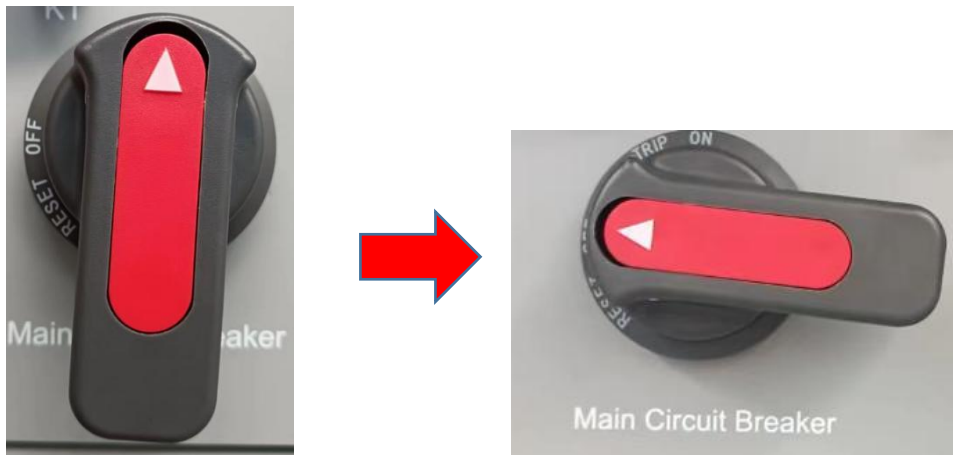

The QF 0 circuit breaker disconnection diagram

- The overall power supply is completed;

警告

The emergency stop button is only used when the machine is faulty or critical. During the normal shutdown, please follow the normal shutdown instructions.

6.6.2 Emergency shutdown sequence



	20KW/50KWH integrated system for High-voltage optical storage Operator manual	filename	202310611
		Authorization date	2023-09-28
		Document Edition	V1.0
		page number	41Page 1 of 19 pages18

emergency stop switch

- (1) Press the emergency stop button directly;
- (2) Then judge the site situation, if the situation is serious, personnel directly evacuated; if the situation can be controlled, according to the normal power process;

警告

The emergency stop button is only used when the machine is faulty or critical. During the normal shutdown, please follow the normal shutdown instructions.

6.7 Technical parameters

project	parameter	remarks
Battery input data		
Battery type	Li-Ion	
Battery voltage range (V)	160~800	
Maximum charging current (A)	37	
Maximum discharge current (A)	37	
Number of battery inputs	1	
Lithium-battery charging strategy	BMS self-adaption	
PV data-in		
Maximum DC input power (W)	26000	
Maximum DC input voltage (V)	1000	
starting voltage (V)	180	
MPPT Range (V)	150-850	
Full-load DC voltage range (V)	500-850	
Limit of DC input voltage (V)	600	
PV input current (A)	26+26	
PV maximum short circuit current Isc (A)	39+39	
MPPT quantity	2	
Number of strings per MPPT group	2+2	
AC output data		
Limit AC output and uninterruptible power supply power (W)	20000	
Maximum AC output power (W)	22000	
Peak power (off-grid)	1.5 x rated power, 10S	

	20KW/50KWH integrated system for High-voltage optical storage Operator manual	filename	202310611
		Authorization date	2023-09-28
		Document Edition	V1.0
		page number	42Page 1 of 19 pages18

AC output limit current (A)	30.4/29.0	
Maximum AC current (A)	33.4/31.9	
Maximum three-phase unbalanced output current (A)	35	
Maximum continuous AC pass-through current (A)	80	
power factor	0.8 leading to 0.8 lagging	
Output frequency and voltage	50/60Hz; 3L/N/PE 220/380, 230/400Vac	
Grid type	three-phase	
Total harmonic distortion (TBD)	<3% (nominal power)	
Direct current injection	<0.5%In	
productiveness		
maximal efficiency	97.60%	
EU efficiency	97.00%	
MPPT productiveness	>99%	
protect		
Photovoltaic input lightning protection	ensemble	
Prevent island protection	ensemble	
Pv string input for reverse polarity protection	ensemble	
Insulation resistance detection	ensemble	
Residual current monitoring unit	ensemble	
Output overcurrent protection	ensemble	
Output short circuit protection	ensemble	
Output overvoltage protection	DC Type II / AC Type III	
Battery overcurrent protection	Fuses	
Certification and Standards		
Grid regulation	IEC 61727, IEC 62116, CEI 0-21, EN 50549, NRS 097, RD 140, UNE 217002, OVE-Richtlinie R25, G99, VDE-AR-N 4105	
EMC/ safety requirement	IEC/EN 61000-6-1/2/3/4, IEC/EN 62109-1, IEC/EN 62109-2	
general data		
working temperature (°C)	-40 to 60°C, > 45°C decrease	
cooling	Intelligent air cooling	
noise (dB)	≤55 dB	
Communication with BMS	RS485, CAN	

	20KW/50KWH integrated system for High-voltage optical storage Operator manual	filename	202310611
		Authorization date	2023-09-28
		Document Edition	V1.0
		page number	43Page 1 of 19 pages18

weight (Kg)	750	
Dimensions (W * D * Hmm)	854*750*2032mm	
levels of protection	IP50	

Seven, daily maintenance and maintenance

7.1 Safety precautions

7.1.1 General provisions for safety

警告

Only qualified and authorized personnel can maintain the system equipment.

In the maintenance work, do not leave the screws, washers and other metal parts in the cabinet, otherwise the equipment may be damaged!

Before opening the cabinet door and starting the formal maintenance work, remove not only all circuit breakers, but also all power switches.

7.1.2 Five safety rules

In order to ensure the safety of the operators, the system equipment must follow the following five safety rules:

- Disconnect all external connections of the cabinet and to the internal power supply of the equipment.
- Ensure that the device is not accidentally re-powered on.
- Use a multimeter to ensure that the maintenance position is completely uncharged.
- Insulate the potentially live parts near the operation part with insulating material.

7.2 Maintenance Work and Cycle

The recommended routine maintenance cycle and work contents are shown in the following table:

scope of examination	Check the method	Maintenance cycle
System running state And the environment	Observe whether the components in the cabinet are damaged or deformed. Listen to the cabinet running for any abnormal sound. When the system runs, check all the variables.	Once every six months

	20KW/50KWH integrated system for High-voltage optical storage Operator manual	filename	202310611
		Authorization date	2023-09-28
		Document Edition	V1.0
		page number	44Page 1 of 19 pages18

	<p>Check whether the main device is normal.</p> <p>Check whether the heating of each component is normal, and use the thermal imager and other monitoring systems.</p> <p>Check the humidity and dust around the cabinet.</p>	
System cleaning	Check the cleaning of the cabinet and the components.	Every six months to once a year (Depends on the dust content of the operating environment)
Power circuit connection	<p>Check whether the power cable connection is loose, and tighten it again according to the previously specified torque.</p> <p>Check the power cables and control cables without damage, especially for cuts to the skin in contact with the metal surface.</p> <p>Check whether the insulation dressing of the power cable terminal has fallen off.</p>	Six months after the first commissioning, Thereafter every six months to a year once
Terminal, line connection	<p>Check whether the control terminal screw is loose, and tighten it with a screwdriver.</p> <p>Check the main loop terminals and the screw overheating.</p> <p>Check the wiring copper bar or screws for color change.</p> <p>Visually inspect the connection and line distribution of equipment terminals.</p>	Once a year
Circuit breaker maintenance	Routine check the corrosion of all metal elements.	Every six months to once a year

	20KW/50KWH integrated system for High-voltage optical storage Operator manual	filename	202310611
		Authorization date	2023-09-28
		Document Edition	V1.0
		page number	45Page 1 of 19 pages18

	Annual inspection of the contactor (auxiliary switch and micro-switch) to ensure that its machinery runs well.	
safety function	Check the stop function of the emergency stop push button. Check the body warning mark and other equipment identification, if blurred or damaged, please replace in time.	Every six months to once a year

The table only contains the recommended product routine maintenance cycles. The actual maintenance cycle shall be reasonably determined by combining with the specific installation environment of the product. Scale, location, and site environment and other factors will affect the maintenance cycle of the product.

7.3 Battery Maintenance Guide

- (1) If the battery is not used for a long time, it should be placed in a cool and dry environment (temperature 10~25 degrees, humidity less than 85%), keep the battery power 50%, and use the mains or solar power charging once every three months.
- (2) The battery should be removed from dangerous goods or dangerous materials, such as corrosive chemicals, dangerous mechanical equipment, high temperature environment, etc.
- (3) The product should be used reasonably, unreasonable use may lead to smoke, such as external short circuit, overcharging, too high ambient temperature, etc. If there is smoke, please cut off the power supply in time, use the carbon dioxide or dry powder fire extinguisher for treatment, and bury it with sand or soil. If necessary, please evacuate the crowd immediately and report to the police.
- (4) If the product is not used reasonably, it may lead to the expansion of the single cell, which may cause the shell rupture or crack. In this case, the company should stop using the battery immediately and contact our relevant technical department or after-sales service department in time.
- (5) Do not remove, puncture, squeeze, hold or bake the battery at high temperature, to avoid excessive vibration, external force impact, high fall, etc. This operation may result in personal injury or property damage.
- (6) Do not trample and collide with the battery box to avoid damage.
- (7) It is forbidden to directly short circuit the positive and negative poles of the battery and avoid any unnecessary metal or conductive material to contact the positive and negative poles, which may cause personal injury or property loss.

	<p style="text-align: center;">20KW/50KWH integrated system for High-voltage optical storage Operator manual</p>	filename	202310611
		Authorization date	2023-09-28
		Document Edition	V1.0
		page number	46Page 1 of 19 pages18

- (8) It is forbidden to expose the battery or put it away in an environment above 60 degrees for a long time, or to heat it or put it into fire, which may lead to personal injury or property damage.
- (9) It is forbidden to charge the battery without the installation of reasonable charging protection device (lithium ion battery protection plate, battery management system, etc.) or the use of informal charging equipment not approved by our company (charger, DC power supply, etc.), which may lead to personal injury or property loss.
- (10) Do not immerse batteries in protected water or conductive liquid, which may result in personal injury or property damage.
- (11) This battery is prohibited by children or nonprofessionals, which may cause personal injury or property damage.
- (12) It is forbidden to use the battery in series or in parallel with other models or types, which may cause battery damage or personal injury or property loss.
- (13) It is prohibited to operate the complete power system of lithium ion battery protection plate or battery management system in series or parallel, which may cause battery damage or personal injury or property loss.
- (14) This product should avoid touching with the water as far as possible. Avoid water to dip into the high and low voltage terminals of the electric box; water into the upper and lower cover of the box; or soak the whole box into water.
- (15) During regular maintenance, it is necessary to check whether the appearance of the cabinet and box is damaged, whether the screw of the fixed box is loose, and whether the connector is in water oxidation.
- (16) Full charge calibration maintenance for SOC and OCV during regular maintenance.

7.4 Replacement of the electronic and electrical components

警告

When replacing the electronic and electrical components in the cabinet, please be sure to replace the same model of components and components products of the same manufacturer! The model of the components can be obtained through the cabinet identification or the identification of the product itself. If you cannot know it, please contact Shandong Haidi New Energy Technology Co., LTD.

警告

If the site needs to replace other manufacturers or different models of products from the same manufacturer, it must be analyzed and confirmed by Shandong Haidi New Energy Technology Co., Ltd. in advance.

otherwise, Shandong Haidi New Energy Technology Co., LTD There is no liability for any casualties or property losses that may be caused thereby.