

Tentative

CONFIDENTIAL

SAMSUNG SDI



PRODUCT SPECIFICATION

4.84kWh 14S1P Lithium Ion Energy Storage System

-Product Number: ELPM482-00005

DRAFT Ver.

CONFIDENTIAL**Revision History**

Rev.	Date	Description	Pages Changed
0.1	'18.09.06	Draft	
0.2	'19.01.25	Draft	
	'19.03.11	Revised Protection function for safety. 7. Protection 8. save data and period	26 - 31
	'19.03.19	4.3 BMS block diagram 4.4 BMS Key components 7. Protection 8. LED Indication 9. Module ID Dip Switch Configuration	
	'19.08.31	Updating for IEC62619 certificate Table8. Detailed CAN Communication Table9.Detailed RS485 Communication Table10. Protection specification Table12. Save data and period	
	'19.09.07	8.2 Error Status Display Table 14 : Indicated error codes	
	'19.09.16	Module ID set	
0.3	'19.10.15	Table 19 : Module Voltage and Internal Impedance	
0.4	'20.02.17	Table 4 : Connector information Table 9 : Protection Specification Table 13 : Indicated error codes 11. CC step charging algorithm 13.7 Preparation Stage—Appearance Inspection (5) Setting the Terminating Resistance 14. Battery Module Replacement	9-10 22-23 27 30 38 42-43
0.5	'20.04.14	Updated the number of table and re-size tables Added CAN/RS485 protocol for reading of Module S/N Added 'Enable/Disable function for CC Step'	14, 18 26
0.6	'20.06.10	Added Transformation of CAN ID for Module Serial Number Response. Added Transformation of the Modbus address for Module Serial Number Response.	14 16

CONFIDENTIAL**Table of Contents**

Revision History.....	2
Table of Contents	3
Figures.....	5
Acronyms and Abbreviations	6
1. Product Overview.....	1
1.1 Scope.....	1
1.2 Product Description	1
2. Safety Information and Handling	2
2.1 Safety Symbols	2
2.2 General Safety Information	3
2.2.1 Protective Equipment.....	3
2.2.2 Organic Solvent Electrolyte.....	3
2.2.3 Electrolyte Vent Product	4
2.2.4 High Voltage Sources.....	4
2.2.5 Unloading and Unpacking.....	4
2.2.6 Storage	5
2.3 General Handling Information	5
3. Module Specification	6
4. Product Structure and Block Diagram.....	7
4.1 Product structure	7
4.2 Front View	7
4.3 BMS block diagram.....	8
4.4 BMS Key components	8
5. Connector Configuration.....	9
5.1 Dry Contact, External LED Specification.....	11
5.2 External connecting ON/OFF push switch Specification	11
6. Protocol.....	12
6.1 Protocol ID Set Dip switch configuration.....	12
6.2 Module to PCS CAN Communication	13
6.3 Module to PCS RS485 Communication	15
7. Protection.....	20
8. Save data and period.....	23
9. LED Indication	24
9.1 Normal Status Display	24
9.2 Error Status Display	24
10. Module ID Dip Switch Configuration.....	25
10.1 Module ID set.....	26
10.2 Dip Switch Set of Single Module System.....	27
11. CC step charging algorithm	27
12. Drawings.....	28
13. Installation.....	29
13.1 Overview	29
13.2 Installation Procedure	30
13.2.1 Preparation Stage.....	30
13.2.2 Module Installation Stage	30
13.2.3 Communication Check	30
13.3 Preparation Stage—Procedure	31
13.4 Preparation Stage—Unpacking and move	31
13.5 Preparation Stage—Communication and Power wire.	32
13.5.1 Communication Wires.....	32
13.5.2 Power Wires	32
13.6 Preparation Stage—Recommended Tools/Instruments	32
13.7 Preparation Stage—Appearance Inspection	33
13.7.1 Appearance Inspection for Module	33
13.8 Module Installation Stage	34
13.9 Battery status check.....	38
14. Battery Module Replacement	39
Contact Information.....	41

CONFIDENTIAL**Tables**

Table 1 : Component Information	1
Table 2 : Safety Symbols	2
Table 3: General Specification	6
Table 4 : BMS Key components	8
Table 5 : Connector information	9
Table 6 : Protocol ID Dip Switch Configuration	12
Table 7 : Detailed Method of Protocol ID Setting.....	12
Table 8 : Detailed CAN Communication	13
Table 9 : Detailed RS485 Communication	15
Table 10 : Protection Specification.....	20
Table 11 : Protection Control	22
Table 12 : Save data and period	23
Table 13 : SOC Indicator	24
Table 14 : Indicated error codes.....	24
Table 15 : ID Dip switch configuration.....	25
Table 16 : Detailed Method of Module ID Setting	26
Table 17 : Single ID Switch set.....	27
Table 18: CC Step function enable / disable using protocol ID dip-switch.....	27
Table 19: Recommended Tools and Instruments	32
Table 20 : Module Voltage and Internal Impedance	34

CONFIDENTIAL**Figures**

Figure 1: Module Assembly.....	1
Figure 2: Storage Guide.....	5
Figure 3 : Module Drawing.....	7
Figure 4 : Module Front Structure.....	7
Figure 5 : Connector Naming	9
Figure 6 : External LED Circuit	11
Figure 7 : Dry Contact Circuit	11
Figure 8 : ON/OFF SWITCH Circuit.....	11
Figure 9 : Protocol ID Switch	12
Figure 10 : CAN ID Switch.....	25
Figure 11 : Module Drawings	28
Figure 12 : Fully installed ESS configuration.....	29
Figure 13 : Single Module configuration	30
Figure 14 : Installation Procedure	30
Figure 15 : Hold the module	31
Figure 16 : Signal connector type.....	32
Figure 17 : Check the Module voltage	33
Figure 18 : Location of ID Dip-switch	33
Figure 19 : Power on switch	34
Figure 20 : Check the Module voltage	34
Figure 21 : CAN ID Setting	34
Figure 22 : Location of TR switch	35
Figure 23 : Signal connector type.....	35
Figure 24 : Signal cable connection.....	36
Figure 25 : Turn on system	37
Figure 26 : Turn off system.....	38
Figure 27 : Power cable connection.....	38
Figure 28 : Disassembly and pull out the defective module	39
Figure 29 : Fully installed ESS configuration.....	40

CONFIDENTIAL**Acronyms and Abbreviations**

The following acronyms and abbreviations are used in this manual.

Acronyms and Abbreviations

Abbreviations	Full Name
BMS	Battery Management System
ESS	Energy Storage System
OTP	Over Temperature Protection
OVP	Over Voltage Protection
TR	Termination Resistor
SOC	State Of Charge
SOH	State Of Health
UTP	Under Temperature Protection
UVP	Under Voltage Protection
PCS	Power Conditioning System
RT	Room Temperature
Deg	Degree
OCP	Over Current Protection
CCL	Charge Current Limitation

1. Product Overview

Product Number: ELPM482-00005

Product Name: 4.84kWh Lithium Ion Energy Storage System

Supplier: Samsung SDI Co., Ltd.

1.1 Scope

This document details the safety and handling information, characteristics, requirements, installation instructions, operating guidelines, service, maintenance and warranty of Lithium Ion Energy Storage System ("ESS" hereinafter) manufactured by Samsung SDI Co., Ltd. It is intended to provide certified personnel and users with information on safe handling, installation and usage of the specified product.

This product is comprised of the following components. Refer to specification documents of each component for detailed information.

Table 1 : Component Information

Component	Product No.
Module Assembly	ELPM482-00005

1.2 Product Description

4.84kWh module is composed of 1P14S by using 94Ah cell and BMS is included. Main functions of BMS are measurement of the cell voltage, temperature, current and calculation of SOC, SOH and Protection the abnormal conditions and communication to PCS.

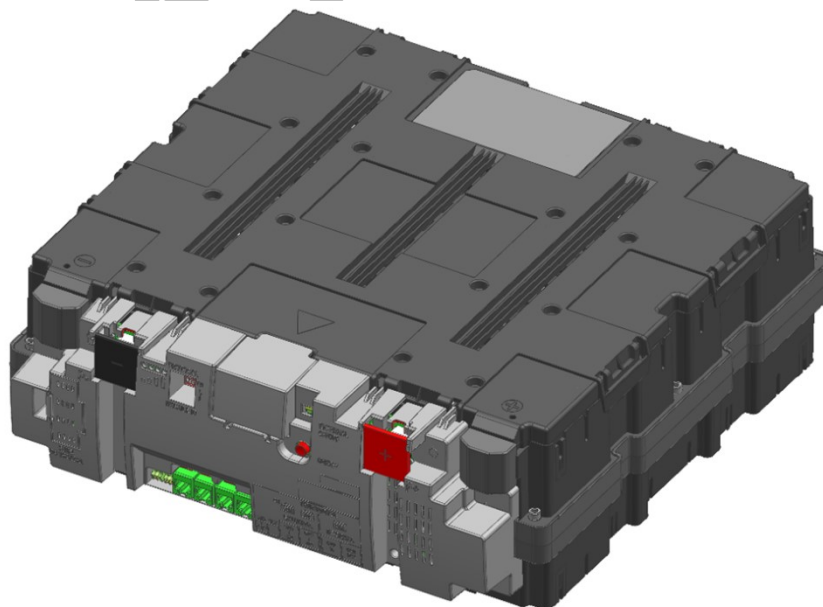











Figure 1: Module Assembly





2. Safety Information and Handling

This Part details the safety information that personnel must fully understand and follow while transporting, storing, installing, operating or servicing the ESS. Before proceeding with unloading, unpacking, handling, installation and operation, read the following details.

2.1 Safety Symbols

Table 2 : Safety Symbols

	<p>DANGER</p> <p>'DANGER' indicates a hazardous situation which will result in death or serious injury if not avoided.</p>
	<p>WARNING</p> <p>'WARNING' indicates a hazardous situation which could result in death or serious injury if not avoided.</p>
	<p>CAUTION</p> <p>'CAUTION' indicates a hazardous situation which could result in minor or moderate injury if not avoided.</p>
	<p>NOTICE</p> <p>'NOTICE' indicates a hazardous situation which could result in property damage if not avoided.</p>
	<p>Energy Storage Device</p> <p>To help avoid burns or electric shock :</p> <ul style="list-style-type: none"> - Service by qualified personnel only - Disconnect main power before maintenance - Turn off the Battery System before maintenance
	<p>Electric shock hazard</p> <p>Do not remove cover or disassemble.</p>
	<p>Explosive gas</p> <p>Do not expose to flame, incinerate, puncture, or impact</p>
	<p>Shield eyes</p> <p>Wear safety goggles at ALL times. (Installation, maintenance, etc.)</p>
	<p>Electrolyte hazard</p> <p>Do not contact eyes, skin or clothing. If it happens, Flush with water and seek medical aid immediately.</p>

	<p>Do not dispose in trash Transport legally. Follow manufacturer's instructions for disposal. Please recycle Lithium ion battery. Do not discard.</p>
	<p>Qualified technicians use this manual for service and replacement.</p>
	<p>This symbol is attached to the position near the DC+, DC- and communication port. If the user wants to access to the points near this symbol, he has to be fully aware of the contents in this manual.</p>
	<p>This symbol is near to the point for grounding. Wire for grounding has to be connected to the point with this symbol.</p>

2.2 General Safety Information

ESS provides a safe source of electrical energy when operated as intended and as designed. Potentially hazardous circumstances such as excessive heat or electrolyte mist may occur under improper operating conditions, damage, misuse and/or abuse. The following safety precautions and the warning messages described in this Part must be observed.

If any of the following precautions are not fully understood, or if you have any questions, contact Customer Support for guidance. The Safety Part may not include all regulations for your locale; personnel working with ESS must review applicable federal, state and local regulations as well as the industry standards regarding this product.

2.2.1 Protective Equipment

When working with ESS, the following personal protective equipment must be worn:

- High voltage rated rubber gloves
- Safety goggles or other eye protection

2.2.2 Organic Solvent Electrolyte

Cell components of ESS contain organic solvent-based electrolyte. Breach of individual cells may allow some electrolyte to be released from the cell. Direct contact with the liquid electrolyte can cause skin irritation.

If contact with the liquid electrolyte occurs, follow the suggestions below to minimize the chance of injury:

- Flush eyes immediately with cold running water for at least 15 minutes.
- Rinse skin immediately with water for at least 15 minutes.
- Remove clothing if soiled.
- Seek immediate medical attention.

2.2.3 Electrolyte Vent Product

The Lithium-Ion chemistry used in ESS contains an organic solvent-based electrolyte. If ESS is misused, damaged or abused, internal cell pressure may increase to excessive levels. Each cell within the ESS is equipped with a non-resettable vent so that if internal cell pressure increases, the cell's vent will activate releasing the electrolyte vent products. When operated as intended and designed, internal cell pressure remains stable and no electrolyte product venting occurs. Other structure (rack, enclosure e.g.) must not interfere gas vent.

Organic solvent electrolyte vent products are flammable. To avoid serious injury from the release and ignition of flammable products, the following guidelines must be observed:

- Operate the ESS under conditions only as specified in this manual.
- Keep sparks, flames and smoking materials away from the ESS.
- Do not incinerate, puncture or impact the ESS.
- Do not solder or weld to the ESS.

2.2.4 High Voltage Sources



DANGER: HIGH VOLTAGE – ELECTRIC SHOCK HAZARD. ESS does not include the enclosure. As all Battery Modules and wires are exposed, the probability of electric shock is high. ESS contains high voltage electric shock sources. Do NOT open any cover of Battery Module.

Exposure to high voltage can cause serious electrical burns, shock or death. To avoid high voltage electrical shock, follow the guidelines below:

- Do not work with high voltages unless you are qualified personnel.
- Personnel must fully understand the safety precautions associated with working on high voltage circuits.
- Personnel must fully understand the risk of working with batteries, and be prepared and equipped to take the necessary safety precautions.
- Necessary equipment, including but not limited to insulated tools, high voltage rated rubber gloves, rubber aprons, safety goggles, and face protection must be used.
- Ensure that the system is powered off and disconnected from outside circuits before servicing the unit.

2.2.5 Unloading and Unpacking

Carefully remove the plastic cover from the pallet. The packages are situated on a pallet on which it can be transported via forklift from location to location.

A damaged box or rattles during transport may indicate rough handling. Make a descriptive notation on the delivery receipt before signing. If damage is found, request an inspection by the carrier and file a damage claim. Pay particular attention to a damaged crate or staining from electrolyte or other fluids. Delay in notifying carrier may result in the loss of reimbursement for damages.

2.2.6 Storage

Follow the guidelines below when storing the Battery Modules.

- The battery module box should be upright as in Figure 2 below. Do not stack or place upside down when storing the battery module box.

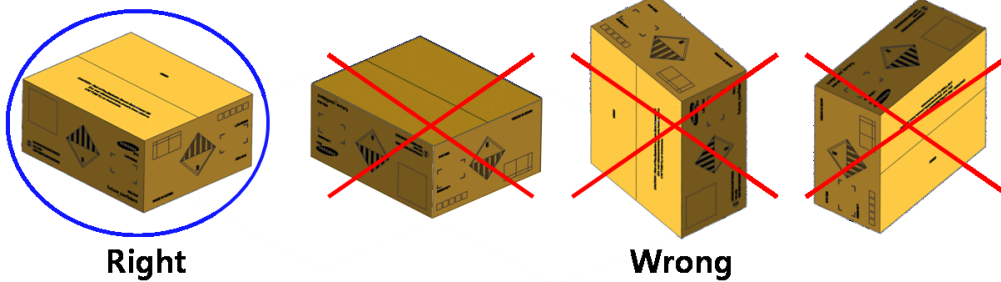

Figure 2: Storage Guide

- Do not stack more than five Battery Module boxes.
- Storage temperature must be in the range of -20 to 60°C.
- Storage humidity must be less than 85% RH under no condensing.
- Capacity degradation will occur depending on storage time.

To minimize capacity degradation, storage temperature should be controlled 25°C

2.3 General Handling Information

Follow the guidelines below when handling the ESS.

- Do not short circuit the positive (+) and negative (-) terminals with metallic object intentionally.
- Do not remove insulation cap on the terminals. If insulation cap is removed, avoid contacting between the metals and the battery terminals. Do not damage the screw thread.
- Do not use seriously scarred or deformed battery. Dispose them immediately according to proper regulations.
- Do not damage sheath of cable and connectors.

3. Module Specification

Table 3: General Specification

No.	Item	Specification	Remarks
1	Dimension[mm]	446 x 440 x 158.2	
2	Weight[kg]	About 34.5	
3	Minimum Capacity	94Ah	1/3C (31A) charge and discharge @R.T
4	Cell Configuration	1P14S	
5	Nominal Capacity	4.84kWh	1/3C @R.T
6	Nominal Voltage ¹	51.52V DC	3.68V/cell
7	Maximum Voltage ¹	58.1V DC	4.15V/cell
8	End of Discharge Voltage ¹	44.8V DC	3.2V/cell
	Standard Discharging Current	31A	1/3C@R.T
	Maximum Discharging Current ²	47A	Cell Temperature -10 ≤ temp < 30°C
		40A	30 ≤ temp < 40°C
25A		40 ≤ temp < 50°C	
9	Charging Method	CC-CV	
	Charging Voltage ¹	58.1V DC	4.15V/cell
	Standard Charging Current	31A	1/3C @R.T
	Maximum Charging Current ²	5A	Cell Temperature -10 ≤ temp < 0°C
		13A	0 ≤ temp < 5°C
24A		5 ≤ temp < 10°C	
35A		10 ≤ temp < 15°C	
	47A	15 ≤ temp < 30°C	
	40A	30 ≤ temp < 40°C	
	20A	40 ≤ temp < 50°C	
10	Cell Temperature Maximum Range	-10 ~ 50 °C	
11	Recommended Operation Temperature	23±5°C	Ambient Temperature
12	Storage Temperature	-20 ~ 60°C	
13	Storage Humidity	Less than 85 % RH	No condensing
14	Storage Period ³	Less than 6 months	
15	External Communication	CAN	2.0A, 500kpbs
		RS485	
16	Scalable Capacity	4.84 ~ 116.16kWh	14S1P ~ 14S24P

¹ Specified voltage must be satisfied in all load and charging conditions.

² Max current are changed according to temperature.

³ The Capacity degradation will occur depending on storage time.

- To minimize capacity degradation, storage temperature should be controlled 25°C.



CAUTION

Caution: If the recommended charge and discharge current specification for the temperature is not followed, cell life cycle degradation may be accelerated. Also, if the system is used at above the recommended current at a high temperature status, ESS operation can be stopped by protection.



WARNING

Warning: If the Module voltage is lower than 44.8V by the long term storage, system operation stop, and long term Commissioning, we strongly recommend recharge the module. If not, the degradation of cell cycle life can be accelerated. Also if the module voltage was being discharged deeper than 21V, it will be irrevocably damaged, resulting in a permanent failure. In case the module cannot be charged such as long-term storage, standing by for Commissioning, and long-term system stop, it is recommended that turned off the module.

4. Product Structure and Block Diagram

4.1 Product structure

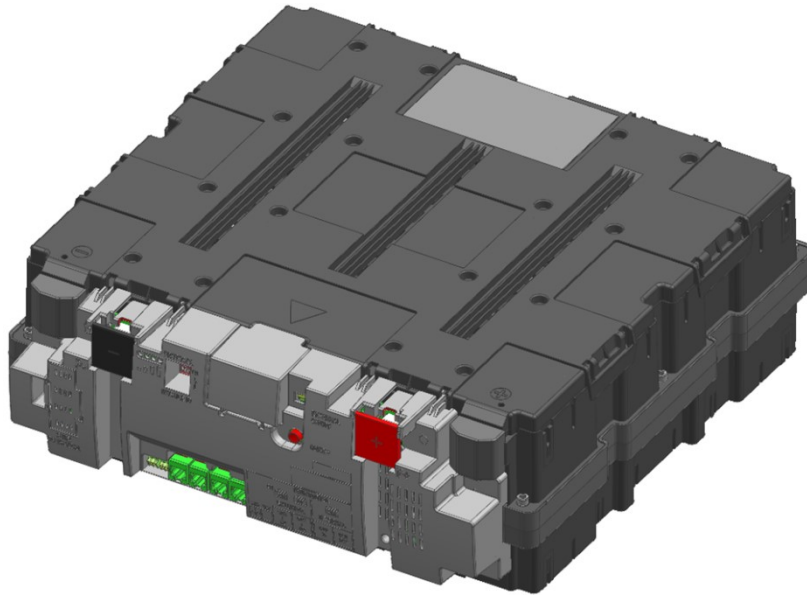

Figure 3 : Module Drawing

4.2 Front View

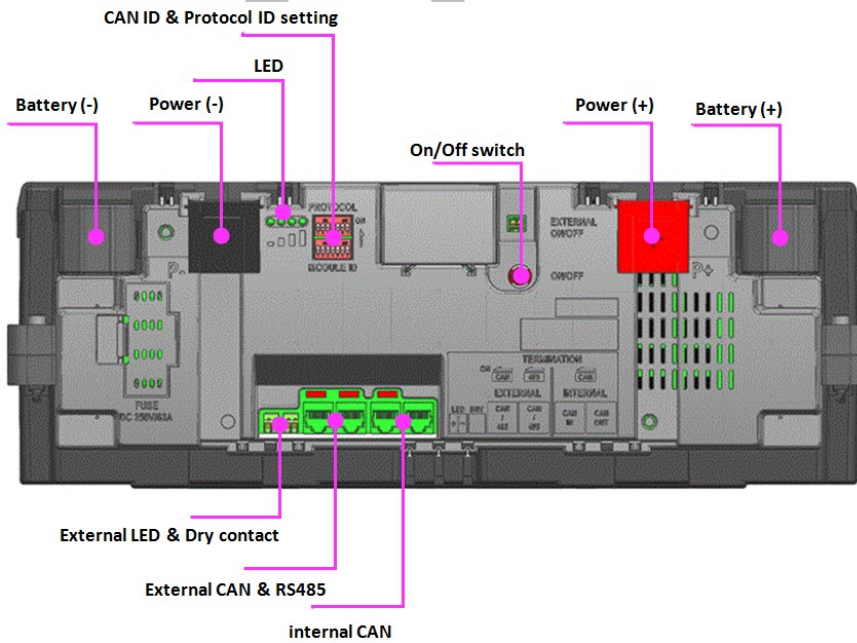
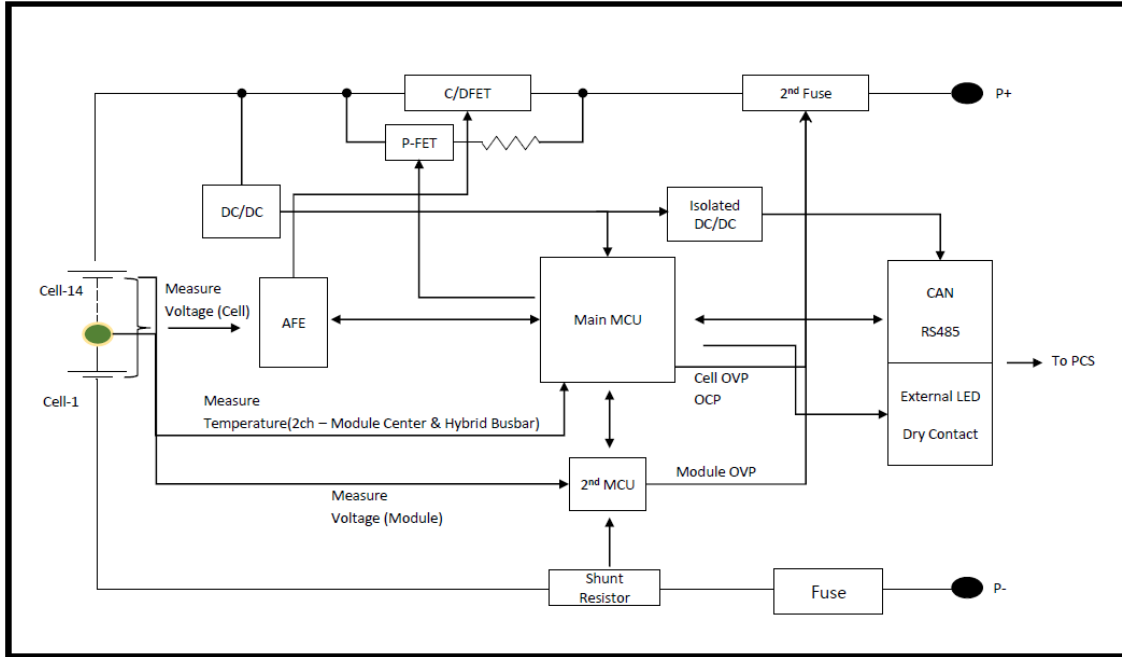

Figure 4 : Module Front Structure

4.3 BMS block diagram



4.4 BMS Key components

Table 4 : BMS Key components

Item	Key components	Spec
MCU	STM32F105VCT6	-
Current Sensing IC	R2A24060	-
AFE	ML5236	14Ch
Shunt Resistor	PSR500HTQFH1L00	1mΩ, 1%, 5W, 2 Parallel
2nd protection fuse	BZ05-640	75A, 64Ω
FET	FDB019N807L	Rated 270A, 80Vdc 5 Parallel
Fuse	250GH-63UL	250V, 63A

5. Connector Configuration

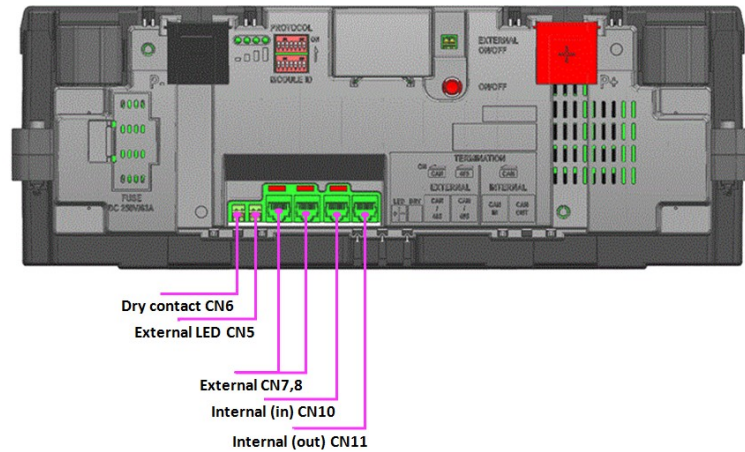
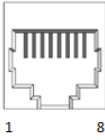
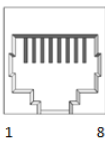
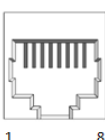





Figure 5 : Connector Naming

Table 5 : Connector information

No	NAME	Start point		
		Housing	Pin No	Pin Map
CN7 CN8	External Communication (CAN, RS485)	 RJ45 8Pin	1	CAN2_H
			2	CAN2_L
			3	GND_CAN
			4	-
			5	RS485 +
			6	RS485 -
			7	RS485 -
			8	RS485 +
CN10	Internal Communication (Input, CAN)	 RJ45 8Pin	1	CAN1_H
			2	CAN1_L
			3	GND_CAN
			4	-
			5	WAKE_UP_IN
			6	-
			7	-
			8	-
CN11	Internal Communication (Output, CAN)	 RJ45 8Pin	1	CAN1_H
			2	CAN1_L
			3	GND_CAN
			4	-
			5	WAKE_UP_OUT
			6	-
			7	-
			8	-
CN5 ¹	External LED	 1 2	1	Contact1
			2	Contact 2
CN6 ¹	Dry Contact	 1 2	1	Contact1
			2	Contact 2
CN13 ¹	ON/OFF SWITCH	 1 2	1	V _{BATT}
			2	GND

¹ Recommended Ferrule and pulling tool

1. Ferrule

- ① AI 0,25 - 8 YE - 3203037 (AWG24, 0.25mm²), Phoenix Contact
- ② AI 0,5 - 8 WH - 3200014 (AWG20, 0.5mm²), Phoenix Contact
- ③ AI 0,75 - 8 GY - 3200519 (AWG18, 0.75mm²), Phoenix Contact

2. Pulling tool

- SZS 0,4 X 2,5 VDE – 1205037, Phoenix Contact

DRAFT Ver.

5.1 Dry Contact, External LED Specification

1) External LED

- Connector: 1752104 (Phoenix Contact)
- 1 channels, Coil driving specification: 5VDC/10mA max
- Normal operating: LED ON, Alarm/Protection: LED Toggle

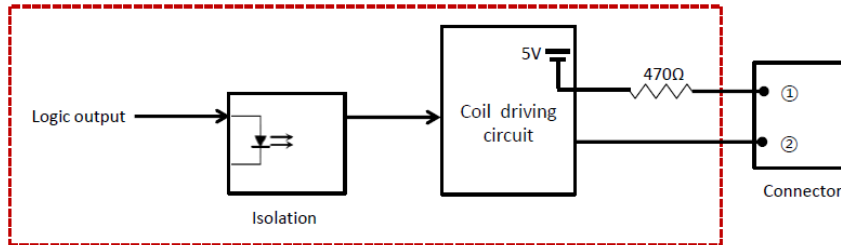

Figure 6 : External LED Circuit

2) Dry contact

- Connector: 1752104 (Phoenix Contact)
- Output: 1 channels, Contact specification: 30VDC/1A max
- Normal operating: short, Alarm/Protection: Open

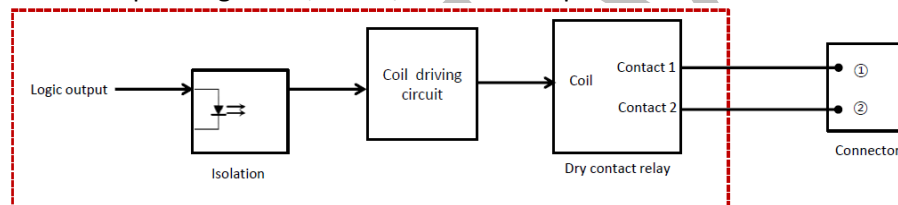

Figure 7 : Dry Contact Circuit

5.2 External connecting ON/OFF push switch Specification

- Connector: 1752104 (Phoenix Contact)
- Switch requirements
 - . Must use push button type
 - . Contact specification: 60VDC ↑ , 100mA ↑
 - . Withstanding voltage: 1,000 VAC ↑
- Operating Sequence
 - . Power ON: Push "ON/OFF SWITCH" on module of CAN ID '1' for more than 2 seconds.
 - . Power OFF: Push "ON/OFF SWITCH" on CAN ID '1' for more than 5 seconds



Caution: Do not press the power switch button for more than 5 seconds during power on status. Module power is turned off if it is pressed for more than 5 seconds.

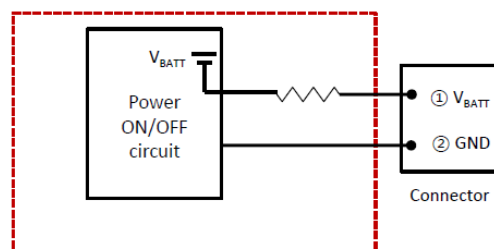

Figure 8 : ON/OFF SWITCH Circuit

6. Protocol

6.1 Protocol ID Set Dip switch configuration

Protocol ID Dip-switch's configuration is as follow.

Table 6 : Protocol ID Dip Switch Configuration

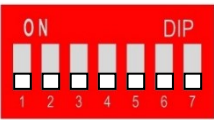
ID Dip-Switch	Switch No	Functions
 <p>Default Status</p>	1	Protocol ID Bit 1
	2	Protocol ID Bit 2
	3	Protocol ID Bit 3
	4	Protocol ID Bit 4
	5	Protocol ID Bit 5
	6	Protocol ID Bit 6
	7	Protocol ID Bit 7

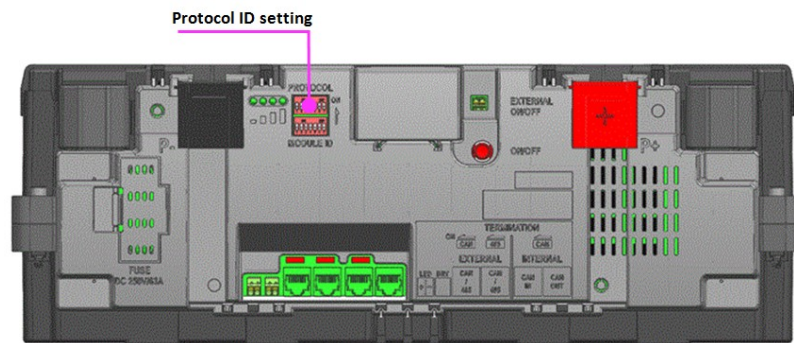

















Figure 9 : Protocol ID Switch

Table 7 : Detailed Method of Protocol ID Setting

Protocol Configuration		CAN Protocol	MODBUS Protocol	
Decimal	Switch	Frame Format	Baud rate(bps)	Parity Bit
0		Standard	9600	Even
1		Extended		Odd
2		Standard		None
3		Extended	19200	Even
4		Standard		Odd
5		Extended		None
6		Standard	38400	Even
7		Extended		Odd
8		Standard		None
9		Extended	57600	Even
10		Standard		Odd
11		Extended		None
12		Standard	115200	Even
13		Extended		Odd
14		Standard		None

6.2 Module to PCS CAN Communication

- Baud rate: 500kbps
- Format: CAN2.0A 11 bit identifier
- Data Length: 8byte
- CAN data is transmitted with encoding in little endian – low byte first – unless stated otherwise.
- Broadcasting period: 500ms

Table 8 : Detailed CAN Communication

- System Information

Name	Data type	Scaling	Unit	Min	Max	Default	Description	CAN ID	CAN Byte	CAN Byte Bit
BMS(Master Tray) → PCS CAN Tx Priod : Every 500ms										
System Voltage	U16	0.01	V				Average tray voltage in normal trays * normal tray : Charge/Discharge FET On	0x500	0	
System Current	S16	1	A				Total current in all tray (Battery Charge : +, Battery Discharge : -)	0x500	2	
System SOC	U8	1	%	0	100		Average SOC in all tray	0x500	4	
System SOH	U8	1	%	0	100		Average SOH in all tray	0x500	5	
System Heart-Beat	U16	1	Dec	0	60000		Heart-Beat Value	0x500	6	
System Alarm Status	Bit	1		0	1	0	Over-Voltage Alarm	0x501	0	0
	Bit	1		0	1	0	Under-Voltage Alarm			1
	Bit	1		0	1	0	Over-Temperature Alarm			2
	Bit	1		0	1	0	Under-Temperature Alarm			3
	Bit	1		0	1	0	Charge Over-Current Alarm			4
	Bit	1		0	1	0	Discharge Over-Current Alarm			5
	Bit	1		0	1	0	FET Over-Temperature Alarm			6
	Bit	1		0	1	0	Tray Voltage Imbalance Alarm			7
	Bit	1		0	1	0	Over-Current Limit Alarm			0
	Bit	1		0	1	0	Voltage Sensor Error Alarm			1
	Bit	1		0	1	0	Temperature Sensor Error Alarm			2
	Bit	1		0	1	0	Current Sensor Error Alarm			3
	Bit	1		0	1	0	Cell Temperature Imbalance Alarm			4
	Bit	1		0	1	0	Cell Voltage Imbalance Alarm			5
Bit	1		0	1	0	PIN Error Alarm	6			
System Protection Status	Bit	1		0	1	0	Over-Voltage Protection	0x501	2	0
	Bit	1		0	1	0	Under-Voltage Protection			1
	Bit	1		0	1	0	Over-Temperature Protection			2
	Bit	1		0	1	0	-			3
	Bit	1		0	1	0	Charge Over-Current Protection			4
	Bit	1		0	1	0	Discharge Over-Current Protection			5
	Bit	1		0	1	0	FET Over-Temperature Protection			6
	Bit	1		0	1	0	-			7
	Bit	1		0	1	0	Tray-ID Error Protection			0
	Bit	1		0	1	0	Voltage Sensor Error Protection			1
	Bit	1		0	1	0	FET Failure Protection			2
	Bit	1		0	1	0	Current Sensor Error Protection			3
	Bit	1		0	1	0	Cell Temperature Imbalance Protection			4
	Bit	1		0	1	0	Cell Voltage Imbalance Protection			5
Bit	1		0	1	0	Shunt Wire Error Protection	6			
Bit	1		0	1	0	-	7			
Number of total trays	U8	1	EA	1	39		Number of Total Tray	0x501	4	
Number of normal operating trays	U8	1	EA				Number of Normal Operating Tray	0x501	5	
Number of fault trays	U8	1	EA				Number of Fault Tray	0x501	6	
Reserved	U8						-	0x501	7	
Battery Charge Voltage	U16	0.1	V			58.1	Set point for battery charge voltage	0x502	0	
Charge Current Limitation	U16	0.1	A	0	1833.0		DC charge current limitation	0x502	2	
Discharge Current Limitation	U16	0.1	A	0	2145.0		DC discharge current limitation	0x502	4	
Battery Discharge Voltage	U16	0.1	V			44.8	Voltage discharge limit	0x502	6	
System Avg. Cell Voltage	U16	0.001	V				Average cell voltage in all tray	0x503	0	
System Max. Cell Voltage	U16	0.001	V				Maximum cell voltage in all tray	0x503	2	
System Min. Cell Voltage	U16	0.001	V				Minimum cell voltage in all tray	0x503	4	
System Avg. Tray Voltage	U16	0.01	V				Average tray voltage in all tray	0x503	6	
System Max. Tray Voltage	U16	0.01	V				Maximum tray voltage in all tray	0x504	0	
System Min. Tray Voltage	U16	0.01	V				Minimum tray voltage in all tray	0x504	2	
System Avg. Cell Temperature	S8	1	degC				Average cell temperature in all tray	0x504	4	
System Max. Cell Temperature	S8	1	degC				Maximum cell temperature in all tray	0x504	5	
System Min. Cell Temperature	S8	1	degC				Minimum cell temperature in all tray	0x504	6	
Reserved	U8						-	0x504	7	
Comm. Protocol Version(Major)	U8	1	Dec	0	255		Communication Protocol Version(Major)	0x505	0	
Comm. Protocol Version(Minor)	U8	1	Dec	0	255		Communication Protocol Version(Minor)	0x505	1	
System Permanent Failure Status 2nd-Protection (Dry-Contact)	Bit	1		0	1	0	Over-Voltage	0x505	2	0
	Bit	1		0	1	0	Cell Voltage Imbalance			1
	Bit	1		0	1	0	Over-Temperature			2
	Bit	1		0	1	0	Charge Over-Current			3
	Bit	1		0	1	0	Discharge Over-Current			4
	Bit	1		0	1	0	FET Failure			5
	Bit	1		0	1	0	Voltage Sensor Error			6
System Permanent Failure Status 2nd-Protection (Fuse-Open)	Bit	1		0	1	0	Over-Voltage	0x505	3	0
	Bit	1		0	1	0	Cell Voltage Imbalance			1
	Bit	1		0	1	0	Over-Temperature			2
	Bit	1		0	1	0	Charge Over-Current			3
	Bit	1		0	1	0	Discharge Over-Current			4
	Bit	1		0	1	0	FET Failure			5
	Bit	1		0	1	0	Voltage Sensor Error			6
Reserved	U8						-	0x505	7	
Reserved	U8						-	0x505	4	
Reserved	U8						-	0x505	5	
Reserved	U8						-	0x505	6	
Reserved	U8						-	0x505	7	

- Tray & Cell information

Name	Data type	Scaling	Unit	Min	Max	Default	Description	CAN ID	CAN Byte	CAN Byte Bit
Tray#01 Voltage	U16	0.01	V					0x510	0	
Tray#01 Current	S16	0.01	A				(Battery Charge : +, Battery Discharge : -)	0x510	2	
Tray#01 SOC	U8	1	%	0	100			0x510	3	
Tray#01 SOH	U8	1	%	0	100			0x510	4	
Tray#01 Alarm Status	U16	1		0	1	0	Refer to the System Alarm Status Bit	0x510	6	
Tray#01 Protection Status	U16	1		0	1	0	Refer to the System Protection Status Bit	0x511	0	
Tray#01 Max. Cell Voltage	U16	0.001	V					0x511	2	
Tray#01 Min. Cell Voltage	U16	0.001	V					0x511	4	
Tray#01 Max. Cell Temperature	S8	1	degC					0x511	6	
Tray#01 Min. Cell Temperature	S8	1	degC					0x511	7	
Tray#01 2nd-Protection (Dry-Contact)	U8	1		0	1	0	Refer to the System Permanent Failure Status 2nd-Protection (Dry-Contact) Bit	0x512	0	
Tray#01 2nd-Protection (Fuse-Open)	U8	1		0	1	0	Refer to the System Permanent Failure Status 2nd-Protection (Fuse-Open) Bit	0x512	1	
Tray#01 Cell Balancing Status	Bit	1		0	1	0	Cell #01	0x512	2	0
	Bit	1		0	1	0	Cell #02			1
	Bit	1		0	1	0	Cell #03			2
	Bit	1		0	1	0	Cell #04			3
	Bit	1		0	1	0	Cell #05			4
	Bit	1		0	1	0	Cell #06			5
	Bit	1		0	1	0	Cell #07			6
	Bit	1		0	1	0	Cell #08	7		
	Bit	1		0	1	0	Cell #09	0		
	Bit	1		0	1	0	Cell #10	0x512	3	1
	Bit	1		0	1	0	Cell #11			2
	Bit	1		0	1	0	Cell #12			3
	Bit	1		0	1	0	Cell #13			4
	Bit	1		0	1	0	Cell #14			5
Bit	1		0	1	0	-	6			
Bit	1		0	1	0	-	7			
F/W Version(Major)	U8	1	Dec	0	255		F/W Version(Major)	0x512	4	
F/W Version(Minor)	U8	1	Dec	0	255		F/W Version(Minor)	0x512	5	
Reserved	U8							0x512	6	
Reserved	U8							0x512	7	
Tray-ID	U16	1	ID	1	39			0x5F0	0	
Cell Voltage #01	U16	0.001	V					0x5F0	2	
Cell Voltage #02	U16	0.001	V					0x5F0	4	
Cell Voltage #03	U16	0.001	V					0x5F0	6	
Tray-ID	U16	1	ID	1	39			0x5F1	0	
Cell Voltage #04	U16	0.001	V					0x5F1	2	
Cell Voltage #05	U16	0.001	V					0x5F1	4	
Cell Voltage #06	U16	0.001	V					0x5F1	6	
Tray-ID	U16	1	ID	1	39			0x5F2	0	
Cell Voltage #07	U16	0.001	V					0x5F2	2	
Cell Voltage #08	U16	0.001	V					0x5F2	4	
Cell Voltage #09	U16	0.001	V					0x5F2	6	
Tray-ID	U16	1	ID	1	39			0x5F3	0	
Cell Voltage #10	U16	0.001	V					0x5F3	2	
Cell Voltage #11	U16	0.001	V					0x5F3	4	
Cell Voltage #12	U16	0.001	V					0x5F3	6	
Tray-ID	U16	1	ID	1	39			0x5F4	0	
Cell Voltage #13	U16	0.001	V					0x5F4	2	
Cell Voltage #14	U16	0.001	V					0x5F4	4	
Reserved	U8							0x5F4	5	
Reserved	U8							0x5F4	6	
Reserved	U8							0x5F4	7	

- Module Serial Number Check

PCS → BMS(All Tray) (Request : Broadcast)										
Serial Number Request	Request Command #1	U8	1				0xA1	Fixed Value	0x600	0
	Request Command #2	U8	1				0xA2	Fixed Value		1
	Request Command #3	U8	1				0xA3	Fixed Value		2
	Request Command #4	U8	1				0xA4	Fixed Value		3
	Request Command #5	U8	1				0xA5	Fixed Value		4
	Request Command #6	U8	1				0xA6	Fixed Value		5
	Request Command #7	U8	1				0xA7	Fixed Value		6
	Request Command #8	U8	1				0xA8	Fixed Value		7
BMS(All Tray) → PCS (Response : Each Tray)										
Serial Number Response	Tray#01 Module Serial Number#01	CHAR	1						0x610	0
	Tray#01 Module Serial Number#02	CHAR	1							1
	Tray#01 Module Serial Number#03	CHAR	1							2
	Tray#01 Module Serial Number#04	CHAR	1							3
	Tray#01 Module Serial Number#05	CHAR	1							4
	Tray#01 Module Serial Number#06	CHAR	1							5
	Tray#01 Module Serial Number#07	CHAR	1							6
	Tray#01 Module Serial Number#08	CHAR	1							7
	Tray#01 Module Serial Number#09	CHAR	1						0	
	Tray#01 Module Serial Number#10	CHAR	1						1	
	Tray#01 Module Serial Number#11	CHAR	1						2	
	Tray#01 Module Serial Number#12	CHAR	1						3	
	Tray#01 Module Serial Number#13	CHAR	1						4	
	Tray#01 Module Serial Number#14	CHAR	1						5	
	Tray#01 Module Serial Number#15	CHAR	1						6	
	Tray#01 Module Serial Number#16	CHAR	1						7	

- Transformation of CAN ID for Module Serial Number Response.

If you want to transform CAN ID for the other module, please refer to the below formula. In this case, 2 characters convert from hex to dec. during transform of CAN ID. After Transforming CAN ID, convert 2 characters from dec to hex.

$$[\text{Last 2 characters in CAN ID for Module No. 1 (dec)}] + [(\text{Module ID No.} - 1) \times 4]$$

Ex1. Module ID 1, 0x610: 10(hex) → 16(dec)

Ex2. Module ID 4, 16 + (4-1)x4 = 28(dec) → 1C(hex)

17 + (4-1)x4 = 29(dec) → 1D(hex)

6.3 Module to PCS RS485 Communication

- Baud rate: 9600bps, 19200bps, 38400bps, 57600bps, 115200bps
- Start-Bit: 1
- Data-Bit: 8
- Stop-Bit: 1
- Parity-Bit: Even / Odd / None

Table 9 : Detailed RS485 Communication

- System information

Category	Function Code	Register (Dec)	Address (Hex)	Data	Description	Data Type	Scale Factor	Unit	Range	Data Definition															
										MSB								LSB							
System Information	0x04	30001	0000	System Heart-beat	System Heart-beat value	U16	1	Dec	0~60000	System Heart-beat															
	0x04	30002	0001	Comm. Protocol Version	LSB : Minor Version MSB : Major Version	U16	1	Dec	-	Major Version								Minor Version							
	0x04	30003	0002	System Voltage	Average tray voltage in normal trays (normal tray : Charge/Discharge FET On)	U16	0.01	V	-	System Voltage															
	0x04	30004	0003	System Current	Total current in all tray (Battery Charge : +, Battery Discharge : -)	S16	1	A	-	System Current															
	0x04	30005	0004	System SOC	Average SOC in all tray	U16	1	%	-	System SOC															
	0x04	30006	0005	System SOH	Average SOH in all tray	U16	1	%	-	System SOH															
	0x04	30007	0006	System Alarm Status	Bit 0 : Over-Voltage Bit 1 : Under-Voltage Bit 2 : Over-Temperature Bit 3 : Under-Temperature Bit 4 : Charge Over-Current Bit 5 : Discharge Over-Current Bit 6 : FET Over-Temperature Bit 7 : Tray Voltage Imbalance Bit 8 : Over-Current Limit Bit 9 : Voltage Sensor Error Bit 10 : Temperature Sensor Error Bit 11 : Current Sensor Error Bit 12 : Cell Temperature Imbalance Bit 13 : Cell Voltage Imbalance Bit 14 : PIN Error Bit 15 : Reserved	U16	1	Bit	-	Bit 15	Bit 14	Bit 13	Bit 12	Bit 11	Bit 10	Bit 9	Bit 8	Bit 7	Bit 6	Bit 5	Bit 4	Bit 3	Bit 2	Bit 1	Bit 0
	0x04	30008	0007	System Protection Status	Bit 0 : Over-Voltage Bit 1 : Under-Voltage Bit 2 : Over-Temperature Bit 3 : Reserved Bit 4 : Charge Over-Current Bit 5 : Discharge Over-Current Bit 6 : FET Over-Temperature Bit 7 : Reserved Bit 8 : Trov Error Bit 9 : Voltage Sensor Error Bit 10 : FET Failure Bit 11 : Current Sensor Error Bit 12 : Cell Temperature Imbalance Bit 13 : Cell Voltage Imbalance Bit 14 : Shunt Wire Error Protection Bit 15 : Reserved	U16	1	Bit	-	Bit 15	Bit 14	Bit 13	Bit 12	Bit 11	Bit 10	Bit 9	Bit 8	Bit 7	Bit 6	Bit 5	Bit 4	Bit 3	Bit 2	Bit 1	Bit 0
	0x04	30009	0008	System Permanent Failure Status 2nd-Protection(Dry-Contact)	Bit 0 : Over-Voltage Bit 1 : Cell Voltage Imbalance Bit 2 : Over-Temperature Bit 3 : Charge Over-Current Bit 4 : Discharge Over-Current Bit 5 : FET Failure Bit 6 : Voltage Sensor Error Bit 7 : Reserved Bit 8 : Reserved Bit 9 : Reserved Bit 10 : Reserved Bit 11 : Reserved Bit 12 : Reserved Bit 13 : Reserved Bit 14 : Reserved Bit 15 : Reserved	U16	1	Bit	-	Bit 15	Bit 14	Bit 13	Bit 12	Bit 11	Bit 10	Bit 9	Bit 8	Bit 7	Bit 6	Bit 5	Bit 4	Bit 3	Bit 2	Bit 1	Bit 0
	0x04	30010	0009	System Permanent Failure Status 2nd-Protection(Fuse-Open)	Bit 0 : Over-Voltage Bit 1 : Cell Voltage Imbalance Bit 2 : Over-Temperature Bit 3 : Charge Over-Current Bit 4 : Discharge Over-Current Bit 5 : FET Failure Bit 6 : Voltage Sensor Error Bit 7 : Reserved Bit 8 : Reserved Bit 9 : Reserved Bit 10 : Reserved Bit 11 : Reserved Bit 12 : Reserved Bit 13 : Reserved Bit 14 : Reserved Bit 15 : Reserved	U16	1	Bit	-	Bit 15	Bit 14	Bit 13	Bit 12	Bit 11	Bit 10	Bit 9	Bit 8	Bit 7	Bit 6	Bit 5	Bit 4	Bit 3	Bit 2	Bit 1	Bit 0
	0x04	30011	000A	Number of total trays	Number of total trays	U16	1	EA	1~39	Number of total trays															
	0x04	30012	000B	Number of normal operating trays	Number of normal operating trays	U16	1	EA	-	Number of normal operating trays															
	0x04	30013	000C	Number of fault trays	Number of fault trays	U16	1	EA	-	Number of fault trays															
	0x04	30014	000D	Battery Charge Voltage	Set point for battery charge voltage	U16	0.01	V	58.10	Battery Charge Voltage															
	0x04	30015	000E	Battery Discharge Voltage	Voltage discharge limit	U16	0.01	V	44.80	Battery Discharge Voltage															

Category	Function Code	Register (Dec)	Address (Hex)	Data	Description	Data Type	Scale Factor	Unit	Range	Data Definition	
										MSB	LSB
0x04	30016	000F	System Charge Current Limmit	System Charge Current Limmit	U16	0.1	A	0~1833.0	System Charge Current Limmit		
	30017	0010	System Discharge Current Limmit	System Discharge Current Limmit	U16	0.1	A	0~2145.0	System Discharge Current Limmit		
	30018	0011	Average Tray Voltage	Average tray voltage in all tray	U16	0.01	V	-	Average Tray Voltage		
	30019	0012	Maximum Tray Voltage	Maximum tray voltage in all tray	U16	0.01	V	-	Maximum Tray Voltage		
	30020	0013	Maximum Tray Voltage Position	Tray-ID	U16	1	ID	1~39	Maximum Tray Voltage Position		
	30021	0014	Minimum Tray Voltage	Minimum tray voltage in all tray	U16	0.01	V	-	Minimum Tray Voltage		
	30022	0015	Minimum Tray Voltage Position	Tray-ID	U16	1	ID	1~39	Minimum Tray Voltage Position		
	30023	0016	Average Cell Voltage	Average cell voltage in all tray	U16	1	mV	-	Average Cell Voltage		
	30024	0017	Maximum Cell Voltage	Maximum cell voltage in all tray	U16	1	mV	-	Maximum Cell Voltage		
	30025	0018	Maximum Cell Voltage Position	Tray-ID	U16	1	ID	1~39	Maximum Cell Voltage Position		
	30026	0019	Minimum Cell Voltage	Minimum cell voltage in all tray	U16	1	mV	-	Minimum Cell Voltage		
	30027	001A	Minimum Cell Voltage Position	Tray-ID	U16	1	ID	1~39	Minimum Cell Voltage Position		
	30028	001B	Average Cell Temperature	Average cell temperature in all tray	U16	1	°C	-	Average Cell Temperature		
	30029	001C	Maximum Cell Temperature	Maximum cell temperature in all tray	U16	1	°C	-	Maximum Cell Temperature		
	30030	001D	Maximum Cell Temperature Position	Tray-ID	U16	1	ID	1~39	Maximum Cell Temperature Position		
	30031	001E	Minimum Cell Temperature	Minimum cell temperature in all tray	U16	1	°C	-	Minimum Cell Temperature		
	30032	001F	Minimum Cell Temperature Position	Tray-ID	U16	1	ID	1~39	Minimum Cell Temperature Position		
	30033	0020	Reserved	-				-			
	30034	0021	Reserved	-				-			
	30035	0022	Reserved	-				-			
	30036	0023	Reserved	-				-			
	30037	0024	Reserved	-				-			
	30038	0025	Reserved	-				-			
	30039	0026	Reserved	-				-			
	30040	0027	Reserved	-				-			

- Transformation of the Modbus address for Module Serial Number Response.
If you want to transform the address for the other module, please refer to the below formula.

The address for Module No. 1 + [(Module ID No. – 1) x50]

Ex. The address for serial number #01~#02 of Module ID 1: 30138

The address for serial number #01~#02 of Module ID 4: 30138 + [(4 -1) x50] = 30288

- Tray information (Ex. #01)

Category	Function Code	Register (Dec)	Address (Hex)	Data	Description	Data Type	Scale Factor	Unit	Range	Data Definition															
										MSB								LSB							
1 T r a y I n f o r m a t i o n	0x04	30101	0064	Tray Heart-beat	Tray Heart-beat value	U16	1	Dec	0~60000	Tray Heart-beat															
	0x04	30102	0065	Tray Voltage	Tray Voltage	U16	0.01	V	-	Tray Voltage															
	0x04	30103	0066	Cell Voltage Sum	Cell Voltage Sum	U16	0.01	V	-	Cell Voltage Sum															
	0x04	30104	0067	Tray Current	Tray Current (Battery Charge +, Battery Discharge : -)	S16	0.01	A	-	Tray Current															
	0x04	30105	0068	Tray SOC	Tray SOC	U16	1	%	-	Tray SOC															
	0x04	30106	0069	Tray SOH	Tray SOH	U16	1	%	-	Tray SOH															
	0x04	30107	006A	Tray Alarm Status	Bit 0 : Over-Voltage Bit 1 : Under-Voltage Bit 2 : Over-Temperature Bit 3 : Under-Temperature Bit 4 : Charge Over-Current Bit 5 : Discharge Over-Current Bit 6 : FET Over-Temperature Bit 7 : Tray Voltage Imbalance Bit 8 : Over-Current Limit Bit 9 : Voltage Sensor Error Bit 10 : Temperature Sensor Error Bit 11 : Current Sensor Error Bit 12 : Cell Temperature Imbalance Bit 13 : Cell Voltage Imbalance Bit 14 : PIN Error Bit 15 : Reserved	U16	1	Bit	-	Bit 15	Bit 14	Bit 13	Bit 12	Bit 11	Bit 10	Bit 9	Bit 8	Bit 7	Bit 6	Bit 5	Bit 4	Bit 3	Bit 2	Bit 1	Bit 0
	0x04	30108	006B	Tray Protection Status	Bit 0 : Over-Voltage Bit 1 : Under-Voltage Bit 2 : Over-Temperature Bit 3 : Reserved Bit 4 : Charge Over-Current Bit 5 : Discharge Over-Current Bit 6 : FET Over-Temperature Bit 7 : Reserved Bit 8 : Tray-ID Error Bit 9 : Voltage Sensor Error Bit 10 : FET Failure Bit 11 : Current Sensor Error Bit 12 : Cell Temperature Imbalance Bit 13 : Cell Voltage Imbalance Bit 14 : Shunt Wire Error Protection Bit 15 : Reserved	U16	1	Bit	-	Bit 15	Bit 14	Bit 13	Bit 12	Bit 11	Bit 10	Bit 9	Bit 8	Bit 7	Bit 6	Bit 5	Bit 4	Bit 3	Bit 2	Bit 1	Bit 0
	0x04	30109	006C	Tray Permanent Failure Status 2nd-Protection(Dry-Contact)	Bit 0 : Over-Voltage Bit 1 : Cell Voltage Imbalance Bit 2 : Over-Temperature Bit 3 : Charge Over-Current Bit 4 : Discharge Over-Current Bit 5 : FET Failure Bit 6 : Voltage Sensor Error Bit 7 : Reserved Bit 8 : Reserved Bit 9 : Reserved Bit 10 : Reserved Bit 11 : Reserved Bit 12 : Reserved Bit 13 : Reserved Bit 14 : Reserved Bit 15 : Reserved	U16	1	Bit	-	Bit 15	Bit 14	Bit 13	Bit 12	Bit 11	Bit 10	Bit 9	Bit 8	Bit 7	Bit 6	Bit 5	Bit 4	Bit 3	Bit 2	Bit 1	Bit 0
	0x04	30110	006D	Tray Permanent Failure Status 2nd-Protection(Fuse-Open)	Bit 0 : Over-Voltage Bit 1 : Cell Voltage Imbalance Bit 2 : Over-Temperature Bit 3 : Charge Over-Current Bit 4 : Discharge Over-Current Bit 5 : FET Failure Bit 6 : Voltage Sensor Error Bit 7 : Reserved Bit 8 : Reserved Bit 9 : Reserved Bit 10 : Reserved Bit 11 : Reserved Bit 12 : Reserved Bit 13 : Reserved Bit 14 : Reserved Bit 15 : Reserved	U16	1	Bit	-	Bit 15	Bit 14	Bit 13	Bit 12	Bit 11	Bit 10	Bit 9	Bit 8	Bit 7	Bit 6	Bit 5	Bit 4	Bit 3	Bit 2	Bit 1	Bit 0
	0x04	30111	006E	Tray Charge Current Limmit	Tray Charge Current Limmit	S16	0.1	A	0~47.0																
	0x04	30112	006F	Tray Discharge Current Limmit	Tray Discharge Current Limmit	S16	0.1	A	0~55.0																
	0x04	30113	0070	Average Cell Voltage	Average cell voltage in tray	U16	1	mV																	
	0x04	30114	0071	Maximum Cell Voltage	Maximum cell voltage in tray	U16	1	mV																	
	0x04	30115	0072	Minimum Cell Voltage	Minimum cell voltage in tray	U16	1	mV																	

Category	Function Code	Register (Dec)	Address (Hex)	Data	Description	Data Type	Scale Factor	Unit	Range	Data Definition															
										MSB								LSB							
T r a y I n f o r m a t i o n	0x04	30116	0073	Average Cell Temperature	Average cell temperature in tray	S16	1	°C	-																
	0x04	30117	0074	Maximum Cell Temperature	Maximum cell temperature in tray	S16	1	°C	-																
	0x04	30118	0075	Minimum Cell Temperature	Minimum cell temperature in tray	S16	1	°C	-																
	0x04	30119	0076	FET Temperature	FET temperature in tray	S16	1	°C	-																
	0x04	30120	0077	Reserved	-																				
	0x04	30121	0078	Tray Switch Status	Bit 0 : Pre-charge FET Bit 1 : Charge FET Bit 2 : Discharge FET Bit 3 : Reserved Bit 4 : Reserved Bit 5 : Reserved Bit 6 : Reserved Bit 7 : Reserved Bit 8 : Reserved Bit 9 : Reserved Bit 10 : Reserved Bit 11 : Reserved Bit 12 : Reserved Bit 13 : Reserved Bit 14 : Reserved Bit 15 : Reserved	U16	1	Bit	-	Bit 15	Bit 14	Bit 13	Bit 12	Bit 11	Bit 10	Bit 9	Bit 8	Bit 7	Bit 6	Bit 5	Bit 4	Bit 3	Bit 2	Bit 1	Bit 0
	0x04	30122	0079	Cell #1 Voltage	Cell #1 voltage in tray	U16	1	mV	-	Cell #1 Voltage Value															
	0x04	30123	007A	Cell #2 Voltage	Cell #2 voltage in tray	U16	1	mV	-	Cell #2 Voltage Value															
	0x04	30124	007B	Cell #3 Voltage	Cell #3 voltage in tray	U16	1	mV	-	Cell #3 Voltage Value															
	0x04	30125	007C	Cell #4 Voltage	Cell #4 voltage in tray	U16	1	mV	-	Cell #4 Voltage Value															
	0x04	30126	007D	Cell #5 Voltage	Cell #5 voltage in tray	U16	1	mV	-	Cell #5 Voltage Value															
	0x04	30127	007E	Cell #6 Voltage	Cell #6 voltage in tray	U16	1	mV	-	Cell #6 Voltage Value															
	0x04	30128	007F	Cell #7 Voltage	Cell #7 voltage in tray	U16	1	mV	-	Cell #7 Voltage Value															
	0x04	30129	0080	Cell #8 Voltage	Cell #8 voltage in tray	U16	1	mV	-	Cell #8 Voltage Value															
	0x04	30130	0081	Cell #9 Voltage	Cell #9 voltage in tray	U16	1	mV	-	Cell #9 Voltage Value															
	0x04	30131	0082	Cell #10 Voltage	Cell #10 voltage in tray	U16	1	mV	-	Cell #10 Voltage Value															
	0x04	30132	0083	Cell #11 Voltage	Cell #11 voltage in tray	U16	1	mV	-	Cell #11 Voltage Value															
	0x04	30133	0084	Cell #12 Voltage	Cell #12 voltage in tray	U16	1	mV	-	Cell #12 Voltage Value															
	0x04	30134	0085	Cell #13 Voltage	Cell #13 voltage in tray	U16	1	mV	-	Cell #13 Voltage Value															
	0x04	30135	0086	Cell #14 Voltage	Cell #14 voltage in tray	U16	1	mV	-	Cell #14 Voltage Value															
	0x04	30136	0087	Cell Balancing Status	Bit 0 : Cell #01 Bit 1 : Cell #02 Bit 2 : Cell #03 Bit 3 : Cell #04 Bit 4 : Cell #05 Bit 5 : Cell #06 Bit 6 : Cell #07 Bit 7 : Cell #08 Bit 8 : Cell #09 Bit 9 : Cell #10 Bit 10 : Cell #11 Bit 11 : Cell #12 Bit 12 : Cell #13 Bit 13 : Cell #14 Bit 14 : Reserved Bit 15 : Reserved				-	Bit 15	Bit 14	Bit 13	Bit 12	Bit 11	Bit 10	Bit 9	Bit 8	Bit 7	Bit 6	Bit 5	Bit 4	Bit 3	Bit 2	Bit 1	Bit 0
	0x04	30137	0088	F/W Verison	F/W Verison	U16	1	Dec	-	Major Verison								Minor Verison							
	0x04	30138	0089	Module Serial Number #01~#02	Serial number #01~#02	U16	1	CHAR	-	Module Serial Number#01								Module Serial Number#02							
	0x04	30139	008A	Module Serial Number #03~#04	Serial number #03~#04	U16	1	CHAR	-	Module Serial Number#03								Module Serial Number#04							
	0x04	30140	008B	Module Serial Number #05~#06	Serial number #05~#06	U16	1	CHAR	-	Module Serial Number#05								Module Serial Number#06							
	0x04	30141	008C	Module Serial Number #07~#08	Serial number #07~#08	U16	1	CHAR	-	Module Serial Number#07								Module Serial Number#08							
0x04	30142	008D	Module Serial Number #09~#10	Serial number #09~#10	U16	1	CHAR	-	Module Serial Number#09								Module Serial Number#10								
0x04	30143	008E	Module Serial Number #11~#12	Serial number #11~#12	U16	1	CHAR	-	Module Serial Number#11								Module Serial Number#12								
0x04	30144	008F	Module Serial Number #13~#14	Serial number #13~#14	U16	1	CHAR	-	Module Serial Number#13								Module Serial Number#14								
0x04	30145	0090	Module Serial Number #15~#16	Serial number #15~#16	U16	1	CHAR	-	Module Serial Number#15								Module Serial Number#16								
0x04	30146	0091	Reserved	-																					
0x04	30147	0092	Reserved	-																					
0x04	30148	0093	Reserved	-																					
0x04	30149	0094	Reserved	-																					
0x04	30150	0095	Reserved	-																					

DRAFT Ver.

7. Protection

BMS Protection will be activated in detection condition, and be deactivated in release condition.

Table 10 : Protection Specification

No	Item	Level	Protection Set						Release Set				
			Condition	Detect (Sec)	Prechg FET	Chg FET	Dchg FET	2nd Fuse	Condition	Detect (Sec)	Prechg FET	Chg FET	Dischg FET
▶ Voltage													
1	Over Voltage	2nd-Protection (Fuse Open)	(Renesas) Tray Voltage \geq 60.2V or (MCU) Max Cell Voltage \geq 4.3V	10	OFF	OFF	OFF	Fusing	PF	-	-	-	-
		2nd-Protection (Dry-contact Signal)	(MCU) Max Cell Voltage \geq 4.3V	5				-					
		Protection (FET Control)	Max Cell Voltage \geq 4.23V or Tray Voltage \geq 59.22V	1	OFF	OFF	OFF	-	Power Reset	-	-	-	-
		Alarm (Communication)	Max Cell Voltage \geq 4.19V or Tray Voltage \geq 58.66V	3	OFF	ON	ON	-	Max Cell Voltage $<$ 4.16V and Tray Voltage $<$ 58.24V	3	OFF	ON	ON
2	Under Voltage	Protection (Shutdown)	(Min Cell Voltage \leq 2.9V and Current \leq 1A) or (Tray Voltage \leq 40.6V and Current \leq 1A)	60	OFF	OFF	OFF	-	Power Reset	-	-	-	-
		Protection (FET Control)	(Min Cell Voltage \leq 2.9V and Current \leq -3A) or (Tray Voltage \leq 40.6V and Current \leq -3A)	20	OFF	OFF	OFF	-					
		Protection (FET Control)	Min Cell Voltage \leq 2.5V or Tray Voltage \leq 35V	3	OFF	OFF	OFF	-	Power Reset	-	-	-	-
		Alarm (Communication)	Min Cell Voltage \leq 2.95V or Tray Voltage \leq 41.3V	1	OFF	ON	ON	-	Min Cell Voltage $>$ 3.1V and Tray Voltage $>$ 43.4V	3	OFF	ON	ON
3	Tray Voltage Imbalance	Alarm (Communication)	Median Tray Voltage - My Tray Voltage \geq 400mV	3	ON	OFF	OFF	-	Median Tray Voltage - My Tray Voltage $<$ 200mV	3	OFF	ON	ON
4	Cell Voltage Imbalance	2nd-Protection (Fuse Open)	Max Cell Voltage \geq 3.8V and Cell V Δ \geq 150mV	10	OFF	OFF	OFF	Fusing	PF	-	-	-	-
		2nd-Protection (Dry-contact Signal)	Max Cell Voltage \geq 3.8V and Cell V Δ \geq 100mV	5	OFF	OFF	OFF	-	Power Reset	-	-	-	-
		Protection (FET Control)	Max Cell Voltage \geq 3.8V and Cell V Δ \geq 30mV	5	OFF	ON	ON	-	Cell V Δ $<$ 30mV	5	OFF	ON	ON
		Alarm (Communication)	Max Cell Voltage \geq 3.8V and Cell V Δ \geq 50mV	5	OFF	ON	ON	-					
▶ Temperature													
5	Cell Over Temperature	2nd-Protection (Fuse Open)	Max Cell Temperature \geq 70°C	10	OFF	OFF	OFF	Fusing	PF	-	-	-	-
		2nd-Protection (Dry-contact Signal)	Max Cell Temperature \geq 70°C	5				-					
		Protection (FET Control)	Max Cell Temperature \geq 65°C	5	OFF	OFF	OFF	-	Power Reset	-	-	-	-
6	Cell Under Temperature	Alarm (Communication)	Max Cell Temperature \geq 60°C	3	OFF	ON	ON	-	Max Cell Temperature $<$ 55°C	3	OFF	ON	ON
		Alarm (Communication)	Min Cell Temperature \leq -15°C	3	OFF	ON	ON	-	Min Cell Temperature $>$ -10°C	3	OFF	ON	ON
7	FET Over Temperature	Protection (FET Control)	FET Temperature \geq 80°C	5	OFF	OFF	OFF	-	Power Reset	-	-	-	-
		Alarm (Communication)	FET Temperature \geq 70°C	3	OFF	ON	ON	-	FET Temperature $<$ 60°C	3	OFF	ON	ON
8	Cell Temperature Imbalance	Protection (FET Control)	(Max Cell T - Min Cell T) \geq 30°C	30	OFF	OFF	OFF	-	Power Reset	-	-	-	-
		Alarm (Communication)	(Max Cell T - Min Cell T) \geq 20°C	30	OFF	ON	ON	-	(Max Cell T - Min Cell T) $<$ 5°C	3	OFF	ON	ON
▶ Current & Power													
9	Over Current	2nd-Protection (FET Control)	Current \geq 55A	50	OFF	OFF	OFF						
		2nd-Protection (Fuse Open)	Current \geq 55A	10	OFF	ON	ON	Fusing	PF	-	-	-	-
		2nd-Protection (Dry-contact Signal)	Current \geq 63A	6	OFF	ON	ON	-					
		Protection (Communication)	63A $>$ Current \geq 55A	6	OFF	ON	ON	-	Power Reset	-	-	-	-
10	Over Current Limit	Alarm (Communication)	Current \geq 52A	1	OFF	ON	ON	-	Current $<$ 47A	3	OFF	ON	ON
		Alarm (Communication)	Current \geq (MCCV + 2A) or Current \leq (MDCV - 2A)	5	OFF	ON	ON	-	Current $<$ MCCV and Current $>$ MDCV	10	OFF	ON	ON

No	Item	Level	Protection Set						Release Set				
			Condition	Detect (Sec)	Prechg FET	Chg FET	Dchg FET	2nd Fuse	Condition	Detect (Sec)	Prechg FET	Chg FET	Dischg FET
Communication													
11	Tray ID Error	Protection (FET Control)	Tray-ID Collision	5	OFF	OFF	OFF	-	Setting the Tray-ID and Power Reset	-	-	-	-
12	PIN Error	Protection (Shutdown)	Not Receive PIN or Receive Mismatch PIN	3600	OFF	OFF	OFF	-	Power Reset	-	-	-	-
		Alarm (Communication)	Not Receive PIN or Receive Mismatching PIN	1800	OFF	ON	ON	-	Receive Matching PIN or Interlock Function Disable	-	-	-	-
Hardware													
13	Voltage Sensor Error	2nd-Protection (Fuse Open)	Voltage Sensor Error Protection Set	10	OFF	OFF	OFF	Fusing	PF	-	-	-	-
		2nd-Protection (Dry-contact Signal)	Voltage Sensor Error Protection Set	5	OFF	OFF	OFF			-	-	-	-
		Protection (FET Control)	Communication Fail or Measurement Holding	30	OFF	OFF	OFF	-	Power Reset	-	-	-	-
		Alarm (Communication)	Communication Fail or Measurement Holding	10	OFF	ON	ON	-	Communication Success and Measurement Not Holding	-	OFF	ON	ON
14	Current Sensor Error	Protection (FET Control)	Status Error or Communication Fail or Measurement Holding	5	OFF	OFF	OFF	-	Power Reset	-	-	-	-
				30	OFF	OFF	OFF	-		-	-	-	-
		Alarm (Communication)	Status Error or Communication Fail or Measurement Holding	3	OFF	ON	ON	-	Status OK and Communication Success and Measurement Not Holding	-	OFF	ON	ON
15	Shunt Wire Error	Protection (FET Control)	$ \text{AvgCellV} (\text{Current} \leq 2\text{A} \ \& \ \text{AvgCellV} > 3.8\text{V} \ \& \ \text{After } 5\text{min}) - \text{AvgCellV} \geq 100\text{mV}$	3	OFF	OFF	OFF	-	Power Reset	-	-	-	-
16	Temperature Sensor Error	Alarm (Communication)	Measurement Holding	1800	OFF	ON	ON	-	Measurement Not Holding	-	OFF	ON	ON
17	FET Failure	2nd-Protection (Fuse Open)	FET Failure Protection Set	10	OFF	OFF	OFF	Fusing	PF	-	-	-	-
		2nd-Protection (Dry-contact Signal)		5	OFF	OFF	OFF	-		-	-	-	-
		Protection (FET Control)	All FET Open and $ \text{Current} \geq 1\text{A}$	10	OFF	OFF	OFF	-	Power Reset	-	-	-	-
		Protection (FET Control)	FET Control Command \neq FET Status	5	OFF	OFF	OFF	-					

Table 11 : Protection Control

Rack BMS will send alarm and protection/Dry contact signal when there is a fault detected in the Battery System. The charger unit, the inverter unit or the PCS must control the battery unit accordingly if alarm and protection/Dry contact are detected by the Rack BMS.

Mode	RBMS	Action of PCS / inverter unit
2nd fusing	2nd protection fuse is open	<p>2nd fusing Disconnect the Battery system by open the 2nd protection fuse in RBMS. SDI Servicing may be needed and should be changed RBMS.</p>
Dry contact	BMS respond CAN dry-contact bit from PCS Fault request and the Dry-contact maintains Low(0V) signal.	<p>Permanent Fault disconnect the battery system by opening the DC relay or external disconnect switch. DC relay or external disconnect switch should be controlled directly by dry-contact(CB AUX or relay power control) SDI Servicing may be needed.</p>
Protection	BMS respond CAN Protection bit from PCS Fault request and the Dry-contact maintains High(5V, max 20mA) signal.	<p>PCS should set the battery system in idle mode(stop charge/discharge) to prevent the fault from escalating to protection mode After the battery system be checked and reset the RBMS for operation.</p>
Alarm	BMS respond CAN Alarm bit from PCS Fault request and the Dry-contact maintains High(5V, max 20mA) signal. If the alarm is cleared, the battery system can be used normally again.	Derating Power.

8. Save data and period

PCS will be saved RS-485 data and daily log for guarantee life and safety of battery.

Table 12 : Save data and period

Function code	data list		period
	Address(Hex)		
0x04	0000 ~ 001F (System information)		Every 20minute
0x04	0065 ~ 0086 (Tray information)		
0x04	0065~0086		Every 1sec for 5minute before alarm/protection/dry-contact triggered
Daily log	Year Month Date Daily lowest SOC (%) Daily highest SOC (%) Daily highest charging power (mW) Daily highest discharging power (mW) Daily aggregated charging energy (mAh) Daily aggregated discharging energy (mAh) Daily standby time (minute) History (Timer counter)		Once a day (Assuming per daily log data and 10 years of operation)

* History counter (current vs temperature)

	$0A \leq I < 3A$	$3A \leq I < 6A$	$6A \leq I < 9A$	$9A \leq I < 12A$	$12A \leq I < 15A$	$15A \leq I < 18A$	$18A \leq I < 20A$	$I \geq 20A$
T < -10°C								
-10°C ≤ T < 0°C								
0°C ≤ T < 10°C								
10°C ≤ T < 20°C								
20°C ≤ T < 30°C								
30°C ≤ T < 40°C								
40°C ≤ T < 50°C								
T ≥ 50°C								

* History counter (standby voltage vs temperature)

	Avg Cell V < 3.0V	$3.0V \leq \text{Avg Cell V} < 3.2V$	$3.2V \leq \text{Avg Cell V} < 3.4V$	$3.4V \leq \text{Avg Cell V} < 3.6V$	$3.6V \leq \text{Avg Cell V} < 3.8V$	$3.8V \leq \text{Avg Cell V} < 4.0V$	$4.0V \leq \text{Avg Cell V} < 4.1V$	$4.1V \leq \text{Avg Cell V}$
T < -10°C								
-10°C ≤ T < 0°C								
0°C ≤ T < 10°C								
10°C ≤ T < 20°C								
20°C ≤ T < 30°C								
30°C ≤ T < 40°C								
40°C ≤ T < 50°C								
T ≥ 50°C								

9. LED Indication

9.1 Normal Status Display

At the normal operation state, the battery LED shows SOC level.

Table 13 : SOC Indicator

SOC	LED #1	LED #2	LED #3	LED #4	LED Ext
0% ~ 24%	On	Off	Off	Off	On
25% ~ 49%	On	On	Off	Off	On
50% ~74%	On	On	On	Off	On
75% ~ 100%	On	On	On	On	On

9.2 Error Status Display

If BMS detects alarm or protection conditions, the LEDs blink.
(In case of over current limit alarm, the all LEDs are off)

Table 14 : Indicated error codes

Index	Item	Status			LED #1	LED #2	LED #3	LED #4	LED Ext	Blink Type
		2sec Toggle	1sec Toggle	500ms Toggle						
1	Over Voltage	Alarm	-	-	Toggle	Off	Off	Off	Toggle	1
		-	Protection	-	Toggle	Off	Off	Off	Toggle	2
		-	-	2nd Protection	Toggle	Off	Off	Off	Toggle	3
2	Under Voltage	Alarm	-	-	Off	Toggle	Off	Off	Toggle	4
		-	Protection	-	Off	Toggle	Off	Off	Toggle	5
3	Over Temperature	Alarm	-	-	Toggle	Toggle	Off	Off	Toggle	6
		-	Protection	-	Toggle	Toggle	Off	Off	Toggle	7
		-	-	2nd Protection	Toggle	Toggle	Off	Off	Toggle	8
4	Under Temperature	Alarm	-	-	Off	Off	Toggle	Off	Toggle	9
5	Charge Over Current	Alarm	-	-	Toggle	Off	Toggle	Off	Toggle	10
		-	Protection	-	Toggle	Off	Toggle	Off	Toggle	11
		-	-	2nd Protection	Toggle	Off	Toggle	Off	Toggle	12
6	Discharge Over Current	Alarm	-	-	Off	Toggle	Toggle	Off	Toggle	13
		-	Protection	-	Off	Toggle	Toggle	Off	Toggle	14
		-	-	2nd Protection	Off	Toggle	Toggle	Off	Toggle	15
7	FET Over Temperature	Alarm	-	-	Toggle	Toggle	Toggle	Off	Toggle	16
		-	Protection	-	Toggle	Toggle	Toggle	Off	Toggle	17
8	Tray Voltage Imbalance	Alarm	-	-	Off	Off	Off	Toggle	Toggle	18
		-	-	-	Off	Off	Off	Toggle	Toggle	19
9	Tray-ID Error PIN Error	Alarm	-	-	Toggle	Off	Off	Toggle	Toggle	20
		-	Protection	-	Toggle	Off	Off	Toggle	Toggle	21
		-	-	-	Off	Toggle	Off	Toggle	Toggle	22
10	Voltage Sensor Error Current Sensor Error Shunt Wire Error Temp. Sensor Error	Alarm	-	-	Off	Toggle	Off	Toggle	Toggle	23
		-	Protection	-	Off	Toggle	Off	Toggle	Toggle	24
		-	-	2nd Protection	Off	Toggle	Off	Toggle	Toggle	25
11	FET Failure	-	Protection	-	Toggle	Toggle	Off	Toggle	Toggle	26
		-	-	2nd Protection	Toggle	Toggle	Off	Toggle	Toggle	27
		Alarm	-	-	Off	Off	Toggle	Toggle	Toggle	28
12	Cell Voltage Imbalance	-	Protection	-	Off	Off	Toggle	Toggle	Toggle	29
		-	-	2nd Protection	Off	Off	Toggle	Toggle	Toggle	30
		Alarm	-	-	Toggle	Off	Toggle	Toggle	Toggle	31
13	Cell Temperature Imbalance	-	Protection	-	Toggle	Off	Toggle	Toggle	Toggle	32
		Alarm	-	-	Off	Toggle	Toggle	Toggle	Toggle	33
14	Over Current Limmit	Alarm	-	-	Off	Toggle	Toggle	Toggle	Toggle	34

10. Module ID Dip Switch Configuration

ID Dip-switch's configuration is as follow. Module ID can be set with switch number from 1 to 6. Switch number 7 is only used in single Module mode. Switch number 7 is used to power on BMS.

Table 15 : ID Dip switch configuration

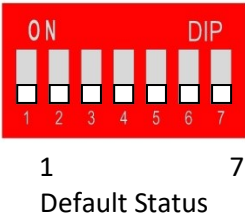
ID Dip-Switch	Switch No	Functions
	1	Module ID Bit 1
	2	Module ID Bit 2
	3	Module ID Bit 3
	4	Module ID Bit 4
	5	Module ID Bit 5
	6	Module ID Bit 6
	7	BMS Power On/Off

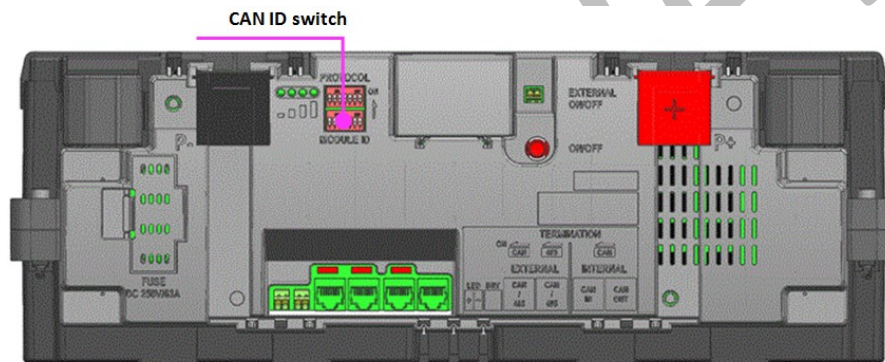

Figure 10 : CAN ID Switch

10.1 Module ID set

Module ID should be set before installation. ID can be set using dip-switch in front of Module. ID is composed of binary number from 0(0000001) to 23 (1110101). Default set value is 0(0000001). The maximum number of the paralleled Module is 24. You must set different Module ID for each Module in the system. Module ID is basically set in increments of '1'.



CAUTION

Caution: Do not set the same Module ID in system. If there is same Module ID in the system, Module do not work.

Table 16 : Detailed Method of Module ID Setting

ID 1 1 7 0000001	ID 2 1 7 1000001	ID 3 1 7 0100001	ID 4 1 7 1100001
ID 5 1 7 0010001	ID 6 1 7 1010001	ID 7 1 7 0110001	ID 8 1 7 1110001
ID 9 1 7 0001001	ID 10 1 7 1001001	ID 11 1 7 0101001	ID 12 1 7 1101001
ID 13 1 7 0011001	ID 14 1 7 1011001	ID 15 1 7 0111001	ID 16 1 7 1111001
ID 17 1 7 0000101	ID 18 1 7 1000101	ID 19 1 7 0100101	ID 20 1 7 1100101
ID 21 1 7 0010101	ID 22 1 7 1010101	ID 23 1 7 0110101	ID 24 1 7 1110101

10.2 Dip Switch Set of Single Module System

In case of Single Module system, ID is set as below.
Module ID is number 0(0000001) and switch number 7 is turned on.

Table 17 : Single ID Switch set

Single Module System	 1 7 0000001
----------------------	---



11. CC step charging algorithm

CC step charging algorithm is used to improve charging sequence. This value is transmitted to the CCL(charge current limitation). CCL is changed according to temperature and number of total trays.

An example of CCL values at temperature between 15°C and 30°C is as below:

- SOC 0 ~ 90% : CCL Max. 47A (100% charge rate)
- SOC 90 ~ 95% : CCL Max. 19A (40% charge rate)
- SOC 95 ~ 98% : CCL Max. 10A (20% charge rate)
- SOC 98 ~ 100% : CCL Max. 5A (10% charge rate)

Table 18: CC Step function enable / disable using protocol ID dip-switch

Step CC enable: Protocol ID 7 OFF (default)	Step CC disable: Protocol ID 7 ON
 1 7 0000001	 1 7 0000001



Caution: CC step function should be set be installation. It can be set using Protocol dip-switch in front of Module.

CAUTION

12. Drawings

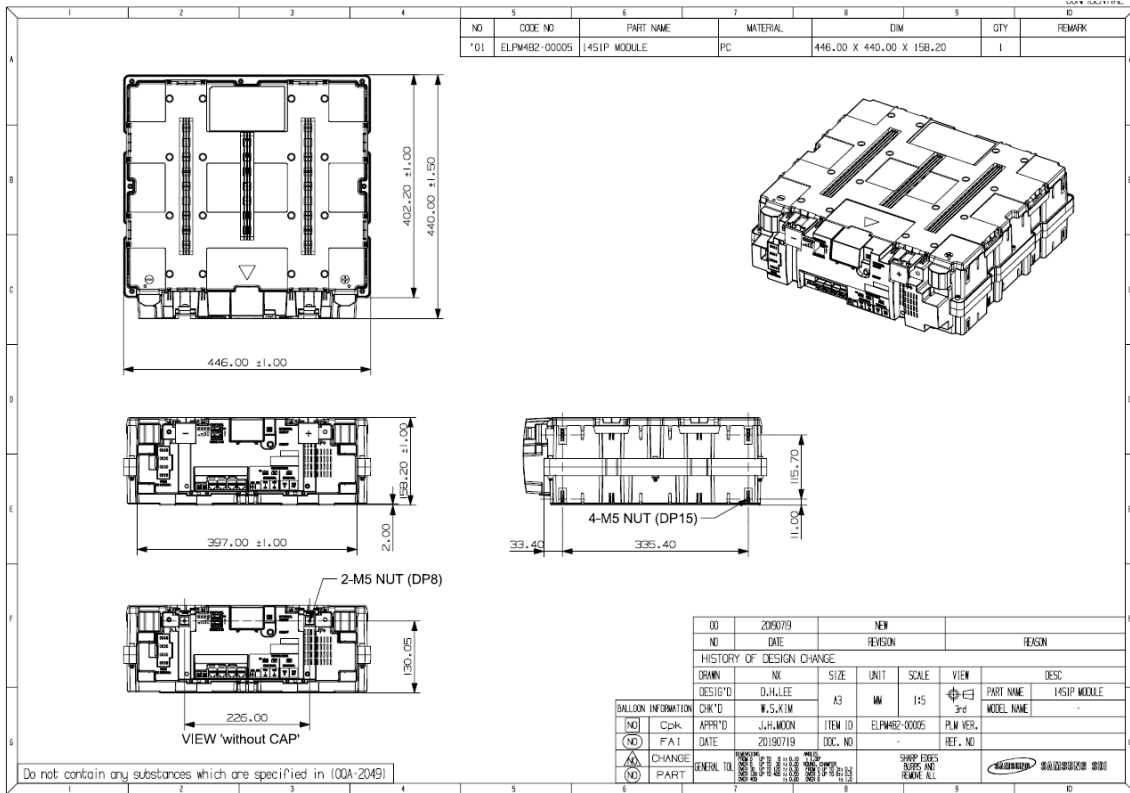

Figure 11 : Module Drawings

13. Installation

13.1 Overview

This section provides detailed information on assembly and installation of ESS. Please be sure to read and fully understand installation manual documents before proceeding Installation. Fully installed ESS is shown as below in Figure 12.

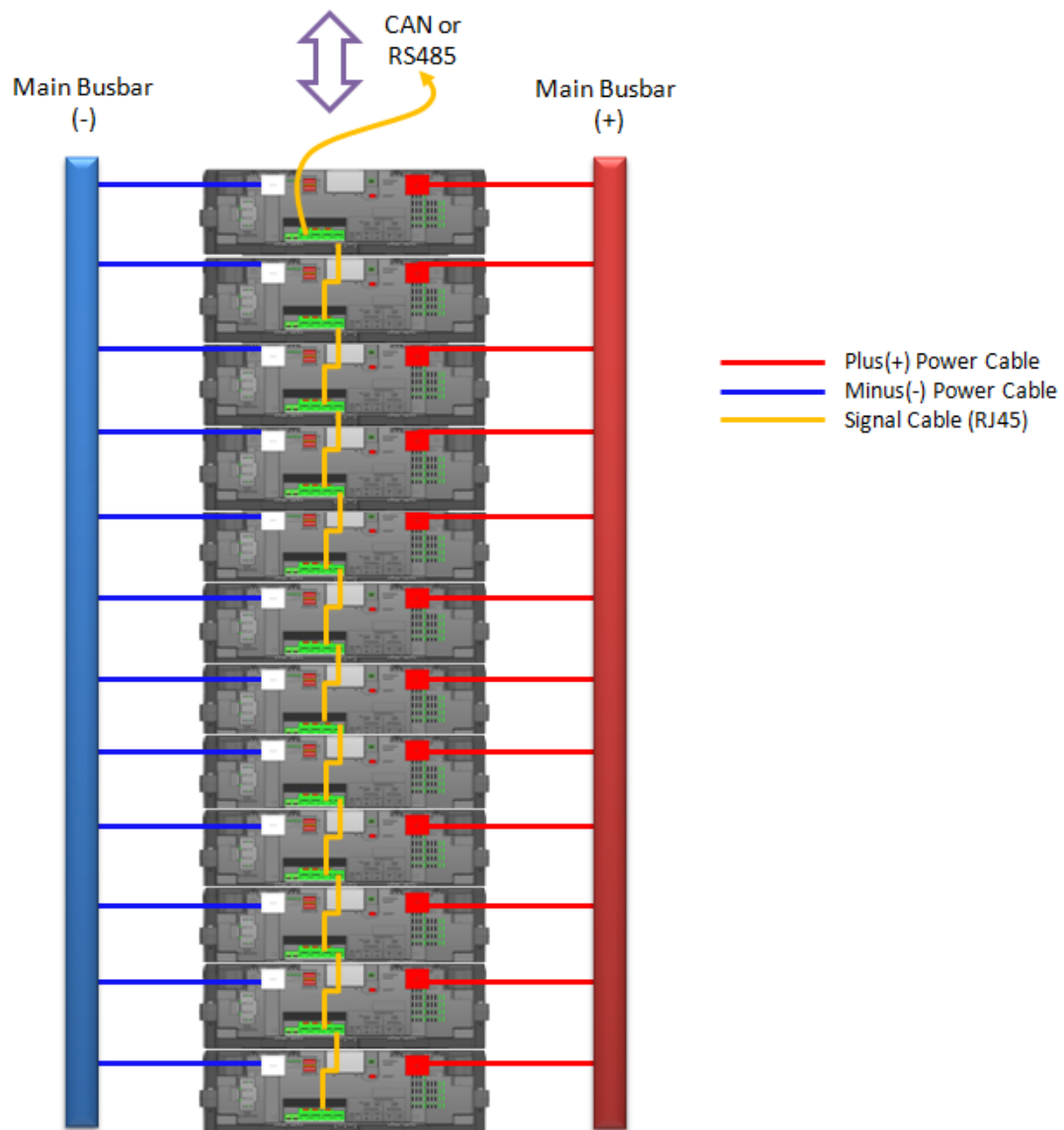

Figure 12 : Fully installed ESS configuration

Single Module configuration is shown below in Figure 13.

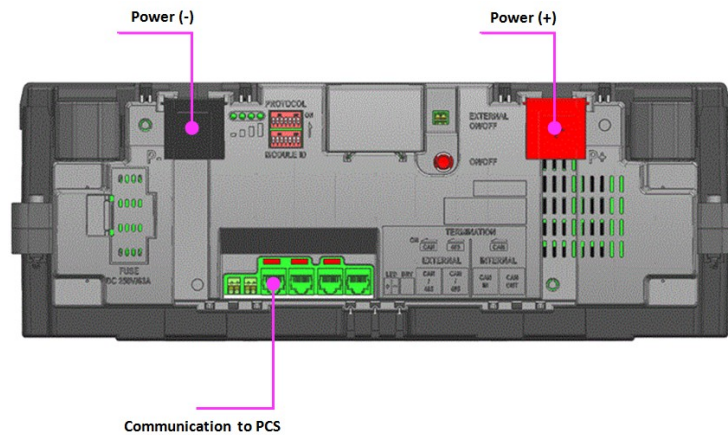

Figure 13 : Single Module configuration

13.2 Installation Procedure

This product must be installed by following the procedure below:

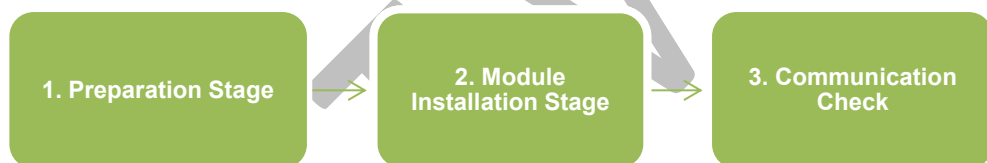

Figure 14 : Installation Procedure

13.2.1 Preparation Stage

- Procedure
- Unpacking
- Communication and Power Wire
- Recommended Tools/Instruments
- Appearance Inspection

13.2.2 Module Installation Stage

- Transport battery modules to the installation place.
- Place the battery modules on the rack frame.
- Measure the voltage of each module
- Setting the CAN ID
- Setting the Terminating Resistance
- Connection the Signal Wire
- Power on the Modules
- Check the LED Status
- Measure the voltage of each module.
- Power Off the modules
- Connecting the power cable
- Power on the Modules
- Check the LED Status

13.2.3 Communication Check

13.3 Preparation Stage—Procedure

For the preparation stage, perform the following steps:

1. Create the installation plan and check the equipment units and instruments for installation.
2. Check the arrival schedule of the parts required.
3. Perform unpacking.
4. Perform the appearance inspection.

	WARNING
	<ul style="list-style-type: none">▪ Do not wear watches, rings, jewelry, or any other metal objects.▪ You shall wear electrically insulated gloves and safety shoes.

	CAUTION
	<ul style="list-style-type: none">▪ Store the product in a dust-free place with the moisture level of below 85% and the temperature level of 23±5°C.▪ Keep components out of direct sunlight.

13.4 Preparation Stage—Unpacking and move

Check the following steps during unpacking.

1. Remove the box taping and remove the cushion in the box.
2. Hold the module side direction.

When you pick up the module holding the module front cover,

It is the possibility of separation from the module body and drop the module

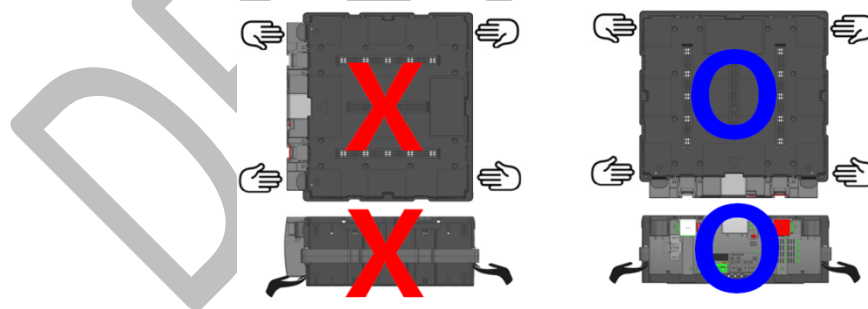



Figure 15 : Hold the module

3. Pick up the module with two people.
4. Transport the module into a workspace.

	WARNING
	<ul style="list-style-type: none">▪ When you pick up the module, you should hold the module side direction

13.5 Preparation Stage—Communication and Power wire.

Communication and power wires are not provided by Samsung SDI, but must be provided by customer to use to racks. Customer-supplied Communication and power wires must adhere to the specifications below.

13.5.1 Communication Wires

Signal connectors use RJ-45 Type connector and Ethernet cable (above CAT-5 standard).

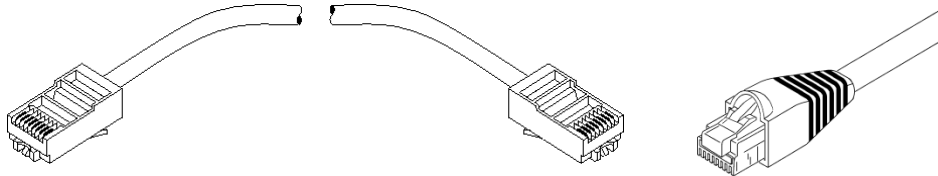

Figure 16 : Signal connector type





13.5.2 Power Wires

Power lugs use Type lug and more than AWG 6 (above CAT-5 standard).

13.6 Preparation Stage—Recommended Tools/Instruments

The required tools and instruments are as follows:

Table 19: Recommended Tools and Instruments

No.	Items	Usage	Shape
1	Power Tool (Max torque: 26N.m/270 kgf.cm)	To fasten Power Cable (3.0 N.m / 30.5 kgf.cm)	
2	Phillips-head Tip	To fasten Power Cable (M6 Tip)	
3	Cutter Knife	Opening boxes	
4	Nipper	Cutting the Power Terminal Cover	
5	Battery Tester	Measure battery module's voltage and internal impedance (ref. HIOKI 3554)	

13.7 Preparation Stage—Appearance Inspection

During appearance inspection, the inspector should check the following cases:

	CAUTION
	<ul style="list-style-type: none">If there are any defects during the visual inspection, contact the SAMSUNG SDI customer service department.

13.7.1 Appearance Inspection for Module

After transporting the module to the designated place, check the followings:

- Physical damage to the exterior
 - Paint peeling
 - Check if the screw is damaged or protruded
 - Check the voltage and internal impedance of the battery modules using the battery tester
 -
- 1) Check the Module Voltage: Confirm the Zero Voltage.

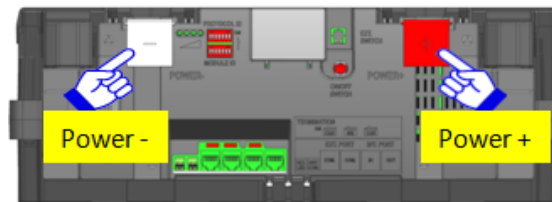

Figure 17 : Check the Module voltage

- 2) Switch number 7 of ID Dip Switch is set for BMS power on: Refer the Figure 18
If Switch number 7 of ID Dip Switch is set, BMS is ready for Power on.

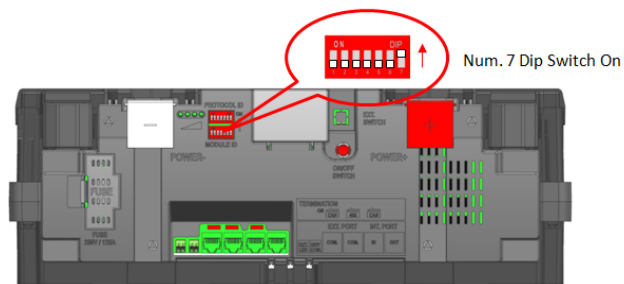

Figure 18 : Location of ID Dip-switch

- 3) Push “ON/OFF SWITCH” on any Module for more than 2 seconds.

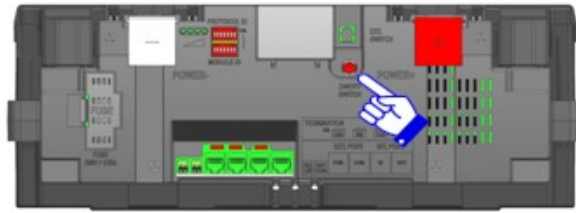

Figure 19 : Power on switch

- 4) Check the LED Status: Refer the section
- 5) Check the Module Voltage and Internal impedance.
- 6) Push "ON/OFF SWITCH" on any Module for more than 5 seconds
- 7) Check the LED OFF

Table 20 : Module Voltage and Internal Impedance

No.	Items	Value
1	Voltage Check	49.876 ~ 50.476V
2	Internal Impedance Check	10.0 ~ 13.0 mΩ

After completion, transport the module to the storage.

13.8 Module Installation Stage

- (1) Transport battery modules to the installation place.
- (2) Place the battery modules on the rack frame.
- (3) Measure the voltage of each module.
Check the module voltage is 0V.

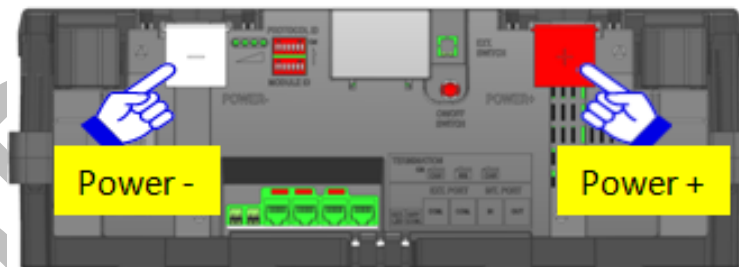

Figure 20 : Check the Module voltage

- (4) Setting the CAN ID: Refer the section 10. Module ID Dip Switch Configuration.

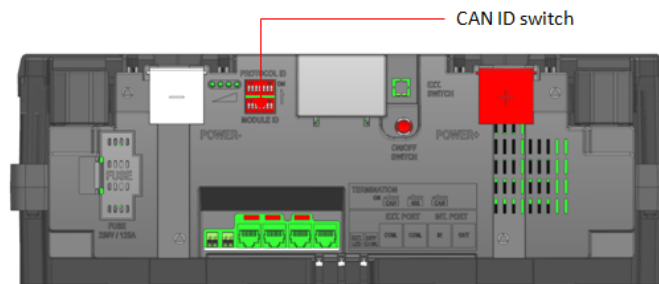

Figure 21 : CAN ID Setting

(5) Setting the Terminating Resistance

1) Internal CAN

Internal CAN BUS is used for communication among the Modules. Terminating resistance must be set at the start and end of the internal CAN BUS. You must turn on the TR switch of first and last Module ID number. The TR switch is turned on in only one(single module system) or two modules in the system.

Ex) 14S1P system: turn on the internal TR switch ID1

Ex) 14S2P system: turn on the internal TR switches ID1 and ID2

Ex) 14S3P system: turn on the internal TR switches ID1 and ID3

Ex) 14S24P system: turn on the internal TR switches ID1 and ID24

2) External CAN and RS485

External CAN and RS485 BUS is used for communication among the PCS. Terminating resistance must be set at the master module(ID1). The TR switch is turned on in only master module(ID1) in the system.



Caution: If internal CAN TR switches is turned on in multiple Modules in same system, system may not work.

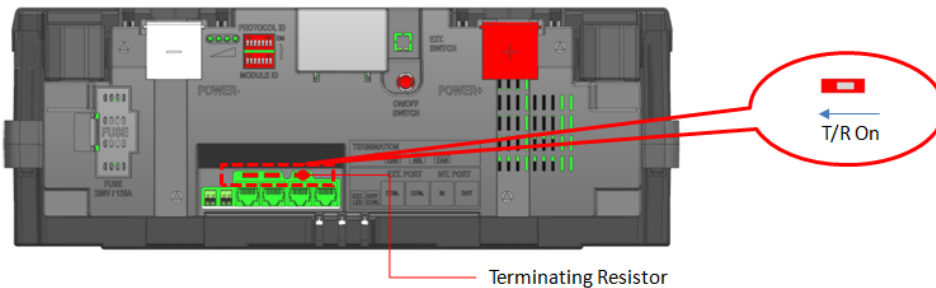

Figure 22 : Location of TR switch

(6) Connection the Signal Wire

1) Signal connector (Not provided)

Signal connectors use RJ-45 Type connector and Ethernet cable (above CAT-5 standard).

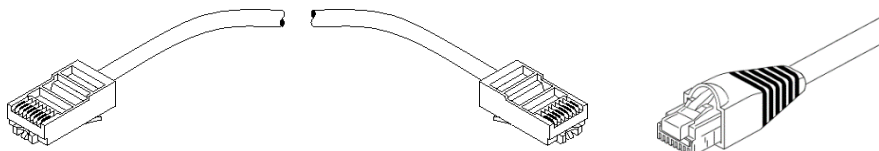

Figure 23 : Signal connector type

Refer to the configuration of signal connector between Modules as below.
Start the Signal Cable connection from CAN out Connector.

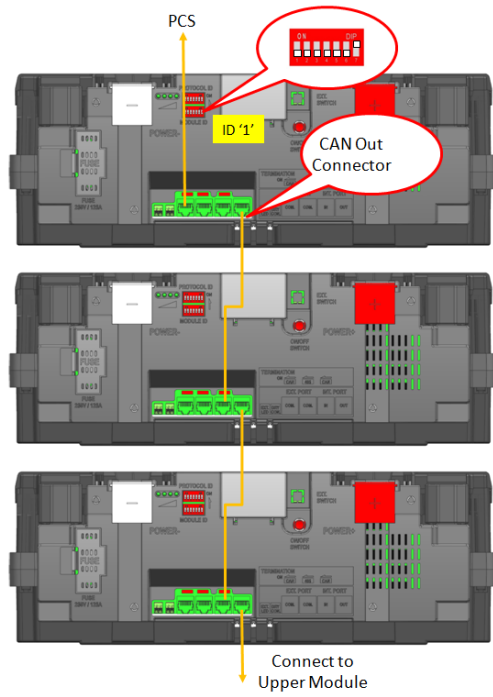

Figure 24 : Signal cable connection

DRAFT

(7) Power on the Modules

Push "ON/OFF SWITCH" on module of CAN ID '1' for more than 2 seconds.
All Modules will be turned on automatically.



Caution: Do not press the power switch button for more than 5 seconds during power on status. Module power is turned off if it is pressed for more than 5 seconds.

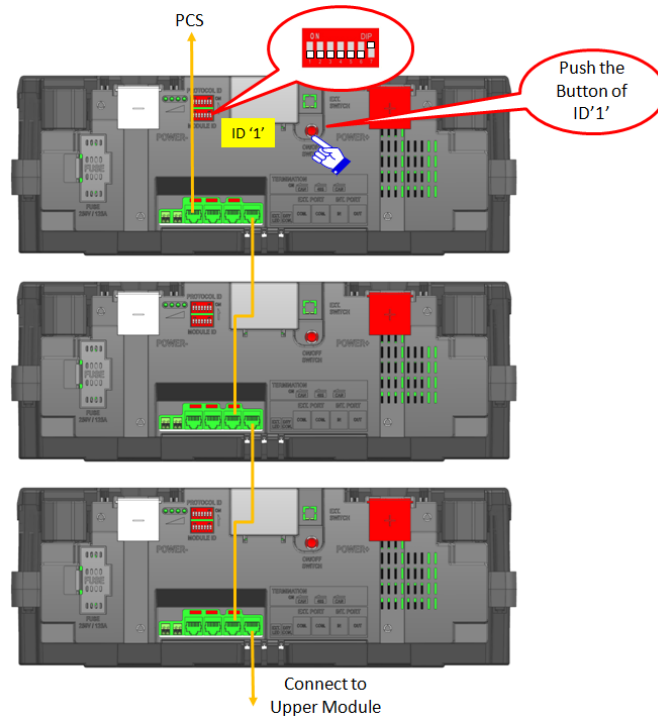

Figure 25 : Turn on system

(8) Check the LED Status: Refer the section
. Confirm the LED of Normal status

(9) Measure the voltage of each module.

All modules within one rack frame must be matched within the voltage difference of 500mV

- (10) Power Off the modules
- System Turn Off Sequence

Push "ON/OFF SWITCH" on CAN ID '1' for more than 5 seconds.

Then all Module power is off except switch-pushed Module. And switch-pushed Module LEDs blink. The Switch-pushed Module power is off when the button is released.

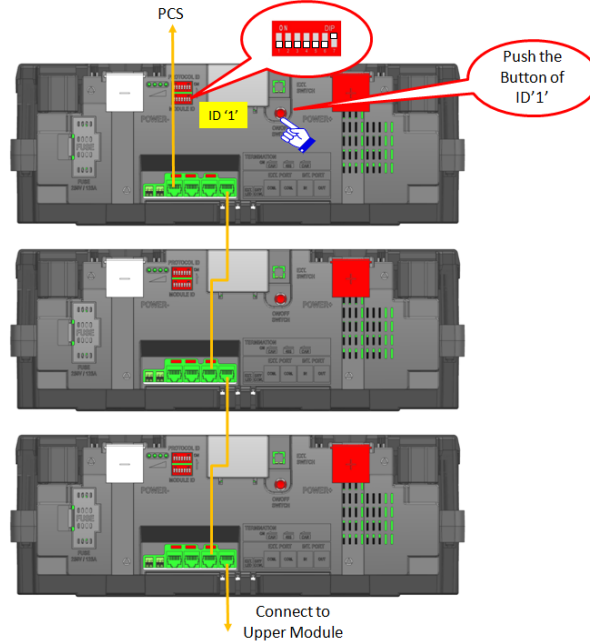

Figure 26 : Turn off system

- (11) Connecting the power cable: refer the figure 12. Fully installed ESS configuration
- Connect the cables to the terminal. Connect the negative cable (-) to the left terminal and positive cable (+) to the right terminal. Tighten the M6 screw to a torque of 3N·m

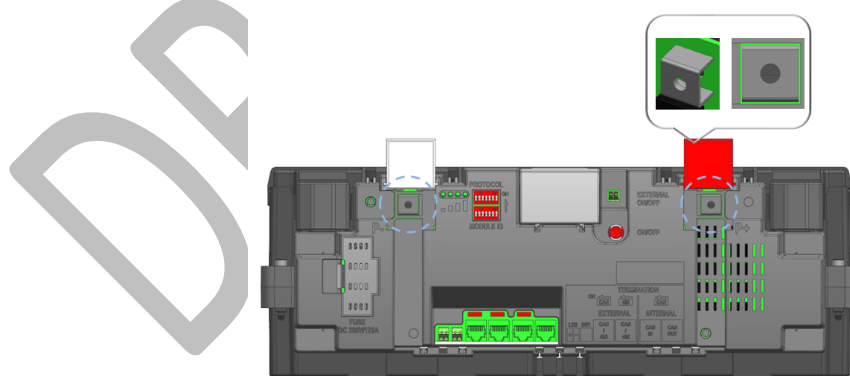



Figure 27 : Power cable connection

- (12) Power on the Modules
 - (13) Check the LED Status: Refer the section "LED indication"
- Confirm the LED of Normal status

13.9 Battery status check

After installation, wiring, and configuration are completed, you must check the communication status by connecting the RS485/CAN cable and run the monitoring program to see whether shows BMS data correctly.

14. Battery Module Replacement

CAUTION	
	<ul style="list-style-type: none"> ▪ Follow the instructions exactly to protect the Battery Module from damage. ▪ DO NOT deviate from the sequence of steps below. ▪ Do not replace and if the temperature range below is out of range $15 \leq \text{temp} < 40^{\circ}\text{C}$ ▪ Do not power ON before connecting signal connector

- (1) Check the environment in system. It can be replaced and operated only following condition.
 : $15 \leq \text{temp} < 40^{\circ}\text{C}$
- (2) Power OFF the whole modules in system.
- (3) Disconnect the signal connector and power cable of defective module.

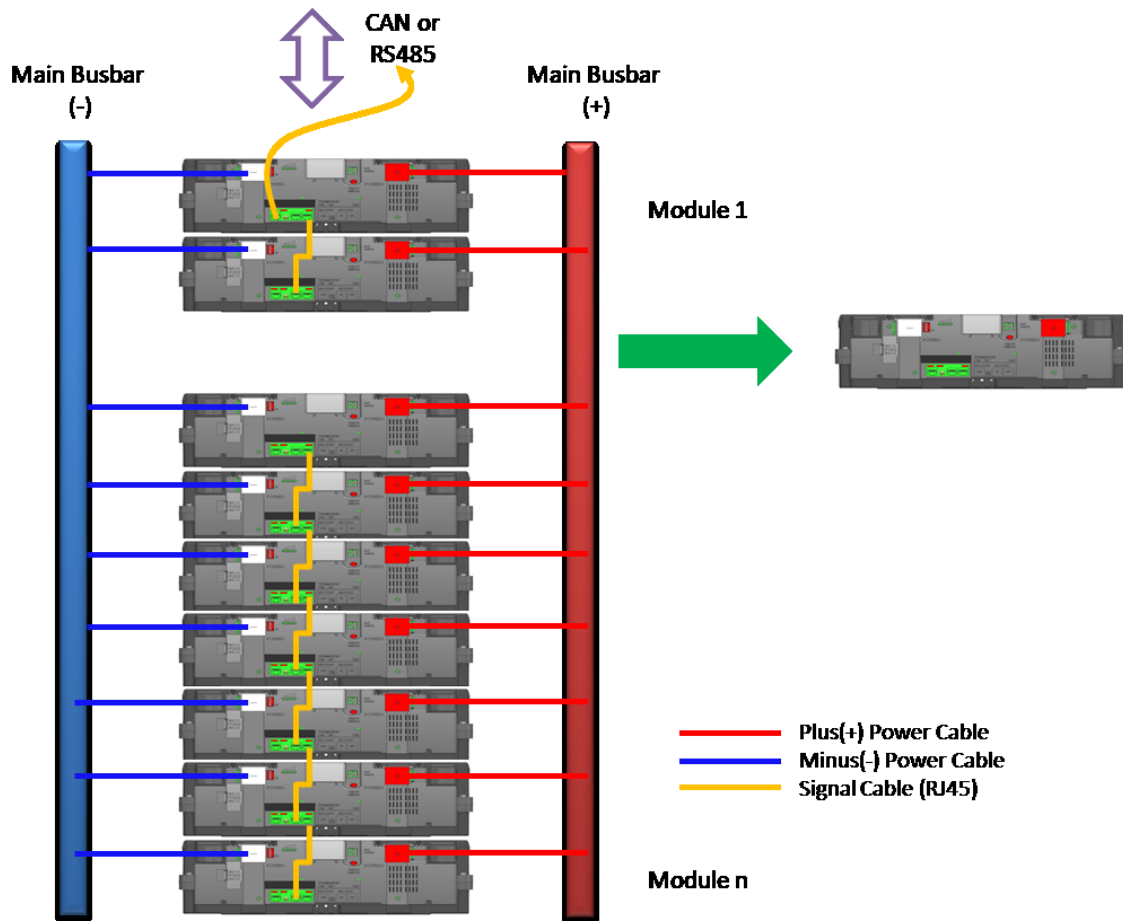

Figure 28 : Disassembly and pull out the defective module

(4) Replace battery module.

(5) Connect the signal connector and power cable of defective module.

(6) Power ON modules in system. Fully installed ESS is shown as below in Figure 29



Caution: Do not power ON before checking fully installed the system

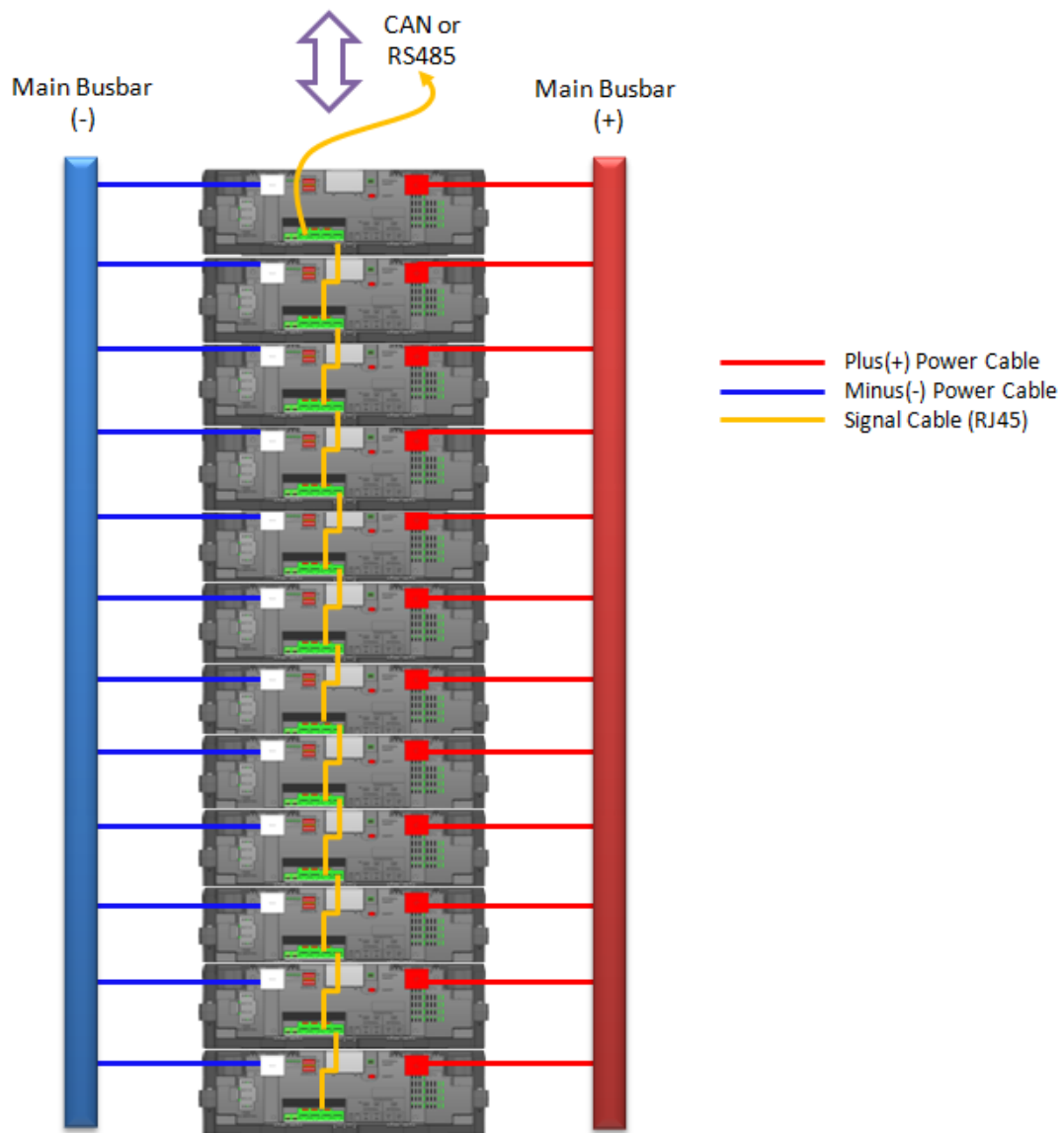

Figure 29 : Fully installed ESS configuration

Contact Information

Corporate Headquarters

Samsung SDI, Co. Ltd.
428-5 Gongse-dong, Giheung-gu, Yongin-si, Gyeongki-do
Republic of Korea
Telephone: 82-31-8006-3369
Homepage: www.samsungsdi.com

Technical Support (Korea)

Samsung SDI, Co. Ltd.
ESS Sales Group
428-5 Gongse-dong, Giheung-gu, Yongin-si, Gyeongki-do
Republic of Korea
Telephone: 82-31-8006-3369
Homepage: www.samsungsdi.com
E-mail: energy.storage@samsung.com

DRAFT Ver.